

INTERNATIONAL RESEARCH IN
ENGINEERING

December 2022

EDITORS

PROF. DR. COŞKUN ÖZALP
ASSOC. PROF. DR. ERTAÇ HÜRDOĞAN

Genel Yayın Yönetmeni / Editor in Chief • C. Cansın Selin Temana

Kapak & İç Tasarım / Cover & Interior Design • Serüven Yayınevi

Birinci Basım / First Edition • © Aralık 2022

ISBN • 978-625-6399-24-2

© copyright

Bu kitabın yayın hakkı Serüven Yayınevi'ne aittir.

Kaynak gösterilmeden alıntı yapılamaz, izin almadan hiçbir yolla

çoğaltılamaz. The right to publish this book belongs to Serüven

Publishing. Citation can not be shown without the source, reproduced in

any way without permission.

Serüven Yayınevi / Serüven Publishing

Türkiye Adres / Turkey Address: Yalı Mahallesi İstikbal Caddesi No:6

Güzelbahçe / İZMİR

Telefon / Phone: 05437675765

web: www.seruyenyayinevi.com

e-mail: seruyenyayinevi@gmail.com

Baskı & Cilt / Printing & Volume

Sertifika / Certificate No: 47083

International Research in Engineering

December 2022

Editors

Prof. Dr. Coşkun ÖZALP
Assoc. Prof. Dr. Ertaç HÜRDOĞAN

CONTENTS

Chapter 1

USE OF WEARABLE TECHNOLOGIES IN DIFFERENT AREAS

Esra TAŞTAN ÖZKAN..... 1

Chapter 2

POLYMERS USED IN THE TEXTILE COATING INDUSTRY, THEIR APPLICATIONS AND THEIR EFFECTS ON HUMAN HEALTH

Aslıhan KORUYUCU..... 19

Chapter 3

THE ROLE OF BUILDING CONTROL FIRMS IN REDUCTION OF OCCUPATIONAL ACCIDENTS IN THE CONSTRUCTION SECTOR

Güliden ASAN, Deniz ERDAL..... 43

Chapter 4

COMPARISON OF GEOGRAPHICAL INFORMATION SYSTEMS (GIS) WITH INTELLIGENCE TRANSPORTATION SYSTEM (ITS) IN INDIA AND JAPAN

Hatice Cana GÜNGÖR, Abdinasir Osman MOHAMED 69

Chapter 5

DETECTION OF SHIPS USING SENTINEL-1 SYNTHETIC APERTURE RADAR IMAGES

Muharrem Hilmi ERKOÇ 77

Chapter 6

DISCRIMINATING OF ESSENTIAL TREMOR AND PARKINSON'S DISEASE USING FREQUENCY ANALYSIS METHOD

Negin MELEK..... 91

Chapter 7

BLOOD GLUCOSE PREDICTION FROM NONDIABETIC AND DIABETIC EXHALED BREATH VIA MACHINE LEARNING

Taleh BINNATOV, Tamila ANUTGAN

Hakan YILMAZ..... 105

Chapter 8

A REVIEW OF NATURAL SYSTEMS FOR WASTEWATER TREATMENT

Nurdan BAYKUŞ..... 127

Chapter 9

PRODUCING LIGHT CONCRETES BY USING AGRICULTURAL WASTE OF RICE

Ayşe BICER, Nevin CELİK..... 145

Chapter 10

AN OVERVIEW OF MICROWAVE NONDESTRUCTIVE TESTING (NDT) METHOD

Ali Recai ÇELİK..... 159

Chapter 11

**INVESTIGATION OF RAINWATER HARVESTING IN A
FACTORY LOCATED IN KÜTAHYA-TURKEY**

İlker KILIÇ..... 169

Chapter 12

**EVALUATION OF PERFORMANCE OF EARTHQUAKE
PARAMETERS BY MACHINE LEARNING (CASE OF STUDY
CENTRAL ANATOLIA REGION)**

Mahmut SARI, Mesut MELEK, Abdullah GERZAN..... 181

Chapter 13

**MODIFICATION OF FLY ASH SUPPLEMENTED CEMENT-
BASED COMPOSITES WITH NANOMATERIALS**

Hamit ÖZTÜRK, Mahmoud ZIADA, Savaş ERDEM..... 197

Chapter 14

**USING BLENDED LEARNING IN TEXTILE ENGINEERING
EDUCATION, AN EXAMPLE OF INTERNSHIP CLASS**

Memik Bunyamin UZUMCU, Tuba BEDEZ UTE 211

Chapter 15

**ROLE OF INTERNET OF THINGS IN SUPPLY CHAIN
MANAGEMENT**

Batin Latif AYLAK..... 223

Chapter 16

APPLICATION OF THE ELMERI SAFETY INDEX METHOD TO SOME CONSTRUCTIONS IN THE ÇORUM REGION TO IMPROVE THE RESPONSIBILITIES OF BUILDING CONTROL FIRMS IN TERMS OF OCCUPATIONAL HEALTH AND SAFETY

Gülden ASAN, Deniz ERDAL 237

Chapter 17

DIGITAL TRANSFORMATION BASED ON SWOT ANALYSIS FOR THE WIDESPREAD USE OF MACHINE LEARNING METHODS IN CONSTRUCTION PROJECT MANAGEMENT

Osman BALLI, İlkin GÜVEN 263

Chapter 18

ELECTRICAL CIRCUIT THEOREMS AND SIMULINK ANALYSIS

Hilmi Zenk, Faruk GÜNER 279

Chapter 19

ANALYSIS OF UNIFORM FRAMES UNDER HORIZONTAL LOADS

Duygu OZTURK, Kanat Burak BOZDOĞAN 315

Chapter 20

CONDITION MATRIX VIA NULL SPACE AND SINGULAR VALUE DECOMPOSITION IN INTEGRATED FORCE METHOD TO ANALYZE SPACE TRUSS

Hamit ÖZTÜRK 331

Chapter 21

AUTONOMOUS CAGE MODEL

FATİH İLKBAHAR, ALI EMRE TERZİ..... 351

Chapter 22

**SLUDGE DISINTEGRATION METHODS TO ENHANCE
ANAEROBIC DIGESTION: AN UP TO DATE REVIEW**

F. Olcay TOPAÇ..... 363

Chapter 23

RESONANCE IN ELECTRICAL CIRCUITS

Hilmi ZENK..... 383

Chapter 24

**RECOMMENDATION OF EIGHT ROTOR UAVS WITH
DIFFERENT CONFIGURATIONS AND COMPARISON OF
FLIGHT PERFORMANCES WITH TWO DIFFERENT UAVS
WITH STANDARD CONFIGURATIONS UNDER IMPACT
FORCE**

Nihat ÇABUK..... 403

“

Chapter 1

USE OF WEARABLE TECHNOLOGIES IN DIFFERENT AREAS

Esra TAŞTAN ÖZKAN¹

”

¹ Assist. Prof. Dr., Bitlis Eren University, Faculty of Fine Arts, Department of Traditional Turkish Arts, Bitlis, Turkey. e-mail: etastan@beu.edu.tr. (ORCID:0000-0001-8950-6048)

1.1. Introduction

Wearable technologies are devices that are worn directly on the human body or loosely attached to the human body. Wearable devices refer to computers and microchips with wireless communication capability incorporated into small electronic and mobile devices or gadgets, accessories, or clothing that can be worn on the human body. The greatest added value of wearable technologies is the ability to monitor and scan biological feedback and biometrics data. There are many applications in this field today. These are smart glasses, wristbands, watches, hats, and gloves. Products defined as smart wearables are the products that can be worn on the body as an accessory such as watches, bracelets, necklaces, and glasses, or can be embedded in clothing such as hats, shirts, trousers, shoes, and gloves (Qiu et al., 2017). Wearable technology products predicted to be 113.2 million in 2017 and have a total market size of 70 billion dollars in 2019, are estimated to reach 222.3 million annual deliveries in 2021 (Ometov et al., 2021, Sharma et al., 2022). Wearable technologies also provide support to information and communication technologies and most of the smart wearable devices have started to be used in business sectors such as personal and industry, health, and sports.



Figure 1. *Examples of wearable technologies*

Wearable technologies are divided into two groups: the first is those that work independently and act as the central connector for other devices (eg, smartphones) and; the secondarily used for taking certain actions or take a measurement (for example, heart rate monitor) without loading it into the primary wearable device for analysis. Smart textiles are formed as a result of electronic or unstitched materials touching the inside of the garment or coming into direct contact with the skin. Wearable technologies have found use in health clothing in a short time due to their data collection and storage features. In this way, a faster method has been provided for patient treatment referral and patient management processes.

The production and use of wearable products using Internet (IoT) technologies are increasing year by year. Small, affordable, and available in a wide variety of shapes, purposes, and applications, IoT devices have led to major advances in telecommunications. Thanks to these technologies, great transformations have occurred in human life. Wearable technologies offer advantages because they offer hands-free access to convenient, trouble-free, portable, and electronic devices, while the disadvantages are that their battery life can be low. The diversity of data collected and processed as a wearable ecosystem has been a new experience for humanity (Ometov et al., 2021). In addition to traditional fitness trackers, smart watches, on-camera worn in the body, heart rate monitors, and glasses, next-generation wearables, as well as various smart clothing, and industrial wearable equipment are examples of wearable textiles. These devices enable communication wirelessly and portability on the body easily, which are used in the production of cutting-edge smart devices. It also has the power to develop established industries for example wearables, the smartphone industry, and other handheld instruments. In previous studies, it was stated that by 2019, the total worldwide wearable device shipments will rise 214.6 million pieces, resulting in a five-year compound annual growth rate of 28% (Shirer et al., 2015). Wearable devices will consequence of an increasingly diverse market, with them generating an annual revenue of over \$150 billion by 2027.

The design of wireless wearables has increased as the sensors used have become miniaturized and specialized operating systems have been developed for networks of sensor units. Researchers have mostly studied the heart and processed data from the heart to monitor vital signs. In a study, it was stated that the sensors used in wearable technologies should be thin, flexible, and compatible with the clothing to be used (Ajami and Teimouri, 2015).

1.2. Evolution of Wearable Technology over Time

The first examples of wearable technologies are which designed by Massimo Ossi in the early 21st century, Levi's industrial jacket. This jacket is produced from technological material designed to interconnect electronic devices. In 2004, a small, lightweight, and waterproof GoPro camera was produced. In 2006, NikeVR invented the Nike β ™ and was associated with AppleVR to produce one of the first wearable devices, the Nike β IPODTM (Erdmier et al., 2016). In 2008, a wireless tracker called Fibrat Classic, which synchronizes internet data, was produced. Samsung S9110 watches with full color touch screen, Bluetooth connectivity, music player and voice identification properties have been released. The first prototype of the device called Google glass was released in 2011. Apple watch manufactured by Apple was produced in 2015. In the next period, Xiaomi and Apple companies offered a wider product range to the market.

Apple Watch measures the user's heart rate through the optical sensors it uses. One of these sensors detects visible light while the other measures the infrared spectrum. As a result, the heartbeat can be measured accurately and reliably even without electrical conductivity. In another technology, known as the Vive bracelet, alcohol and hydration levels of people can be measured with the help of a smartphone.

Another device collects heart rate data, consumption of calories, sleep stages, sweating, and skin temperature, with the Basis Body IQ produced in 2014. Also, the Tommy Hilfiger brand produced a jacket by sewing solar cells into the jacket for the purpose of charging phones in 2014. Wearable technologies are divided into 5 groups:

1. Head Worn Technologies: headphones, personal assistants, bass systems. Several head-worn imaging devices have now been described that are used in simulation during surgery, education, and as a navigation tool. Google glass technology can be given as an example of a device that allows hands-free thanks to its head-mounting feature. The areas where this technology is used are HD recordings of office visits, direct connection to patient support services, and real-time information reporting with other hospital institutions (Ajami and Teimori, 2015).

2. Body-worn technologies: headphones, personal assistants, and bass systems can be given as examples of these technologies.

3. Body-worn and Sports: activity tracking sensors, e-patches, and smart bands can be given as examples of these technologies. Devices that complete the existing wearable ecosystem.

4. On the body: EEG and ECG monitors, posture correction devices, safety devices, and various smart clothing are included in this group (Ometov et al., 2021).

5. Applied inside the body: They can be medically implanted, smart tattoos, etc. example can be given.

- ❖ Lower-body devices: Examples of this group are smart shoes, belts, insoles, etc. Some wearables such as carry special monitoring functions for sports or medical areas.

- ❖ Wrist-worn and hand-held wearables: Smart wristbands, smart watches, and gesture control devices are in this group. Since heart rhythm measuring devices used on the wrist detect changes in the patient faster than the systems used by nurses, they increase inpatient safety. Even in the intensive care setting, the heart rhythm of hospitalized patients is measured only 2-3 times in 24 hours by cEKG. It has been stated that early warning systems (EWSs) used in wearable technologies can accurately predict cardiac arrest and hospital mortality (Kroll et al., 2016).

Also, wearables are divided into groups as low, medium, and high power wearables.

- Low- Devices used for data collection and control of wearable products with low batteries are included in this group. Small battery sensors and radio systems, which are mostly used in the health sector, fall into this group.

- Medium power products need slightly higher capacity than low battery ones. The sensors used here have direct or indirect connections to the internet. Examples of these are smartwatches, fitness trackers, and other activity or motion tracking systems.

- High-power wearables need high power, they have higher data collection capabilities, and they have larger screens. In addition, machine learning, specified as ML, offers different calculation options with real-time viewing or videos.

The sections of smart devices can be divided into two groups and described below.

Hardware:

They use an accelerator and gyroscope to control the user's movement type and movement, while devices called GPS are used to track the user's location and movement speed (Qiu et al., 2017). They utilize actuators for example vibrators and speakers to inform the user of a group of reactions. They usually contact the data center with Bluetooth.

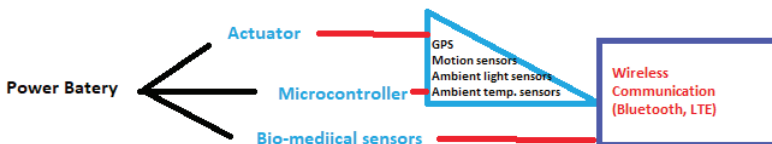

Figure 2. *Hardware of smart wearables*

Software:

Thanks to this software, they operate like the center of sensors and actuators with restricted working power. Due to these software, data is collected in a data collection center or commands are carried out in line with the data coming from the data center. The software named Mi Band is a registered brand with simple software released by the Xiaomi company. Xiaomi's Huami Amazfit sports watch company prefers Android as its operating system. In addition, other managing systems utilized for smart wearable devices include iOS, Tizen, and Linux (Url-1).

1.3. Use of Wearable Technologies in Healthcare

Wireless Health Monitoring System is used for receiving up-to-date medical data of patients and permanent watching of muscle movements, respiration, and EKG for the patient through a textile sensor placed in a wireless capable garment (Chika and Adekunle, 2017). The framework includes fully woven textile sensors, a miniature electronic panel for movement control, signal preprocessing, and a sensitized vest tied via Bluetooth for information transfer. An in-ear device has been produced by Vogel to measure the heart rhythm and the amount of oxygen in the blood. Ordinary clinical or hospital watching of physiological cases, such as an electrocardiogram or blood pressure, provides superficial information about the patient's physiology.



Figure 3. *Use of wearable Technologies in healthcare*

(<https://digitalhealth.folio3.com/blog/future-of-wearable-technology-in-healthcare/>, date 20.12.2022)

There are three major restrictions to classifying such short clinical follow-up periods: 1) they may be unsuccessful in uncommon cases that may have deep diagnostic, prognostic or therapeutic importance; 2) they unsuccessful to evaluate physiological responses during normal times of activity, rest, and sleep, which are more exact signs of a patient's health and reaction to therapeutic interposition, and 3) short monitoring periods fail to capture circadian variation in daily life. It serves to monitor and not record physiological signals intermittently or continuously. Thus, it provides an understanding of new diagnostic and therapeutic ways for patient care. Smartwatches are the name given to watches that resemble traditional watches with touch screens for monitoring and tracking heart rate and other vital body phenomena.

A tracker, on the other hand, is a wearable device that can observe people or objects in motion and provide a timely sequenced array of position output. Smart Glasses are wearable computer glasses that attach knowledge to or near what the user watches. This equipment can be used by the elderly and caregivers. They can also develop their standard of living by allowing communication between patients, caregivers, and outsiders. They also allow connectivity with other types of technology such as computers, tablets, and smartphones (Srizongkhram et al., 2018).

Smart suits can be made of conductive fiber to collect electrocardiography (ECG) signals. The design of smart clothes has been differentiated in order to enable the elderly to wear them more comfortably and to meet different demands. Four electrodes directly in contact with the skin were sewn to the smart clothes on both sides of the shoulder and rib cage.

In later studies, scientists designed garments that could measure blood flow, oxygen, and nutrient amounts. These garments contain electrodes that shock the body to increase blood flow in the necessary areas in case of emergency. As a result, the formation of bedsores on the body is reduced. The sensors used in these garments are divided into five:

(1) Electrocardiography (ECG) sensors to control heart rhythms: The first of the most used methods are the devices that measure the necessary signals in vital situations such as EKG, breathing, and movement. Traditional heart watching resolutions have been available for many years, such as the Holter device, which collects the patient's ECG data for 24-48 hours and all recordings are then examined by the cardiologist. So, real-time acquisition and processing of breathing and movement and ECG signal will enable continuous definition and alarming of a big event and instantaneous heart defect. There are also ECGs with Bluetooth capability. When they notice an abnormal situation in the patient, an alarm is given to the patient's family or doctor via mobile devices. The smart bracelet named Vital-ECG, developed by Neuronica Lab is based on the device named ECGWatch, which was previously developed by the same company. This device is cheaper, can work with smartphones, and measures parameters such as electrocardiogram, heart rate, blood oxygen level, temperature, and humidity of the skin and patient physical activity (Randazzo et al., 2018).

(2) Accelerometers and activities to detect body posture: It also allows clinicians to distantly and modestly specify useful actions and/or motion irregularities such as Parkinson's ill, tremors, and dyskinesia. Apart from this, there are accelerometers used to measure sleep quality or monitor physical activities such as walking and running. Accelerometers, which measure according to the mass spring measurement principle, measure body movement depending on the rate of change of velocity.

(3) Electromyography (EMG) sensors to control the deterioration of body muscle,

(4) Breathing sensors to control the user's breathing: It is also used for home sleep apnea control and investigation, particularly for monitoring during the sleep state.

(5) Body temperature sensors: Scientists have stated that long-term follow-up of physiological data, which will cause important developments in the treatment and diagnosis of heart diseases, will lead to much development in this field. Manual and electronic systems are used to measure body temperature, which is defined as fever. Recording of these data can only be done on paper. However, with the help of wearable technologies, a system can be created in which data is constantly sent to the computer environment.

An example of wearable technologies used to predict health problems is the Crhonolife smart vest, a device that notifies you of a heart attack without warning. There are heart rate monitor technologies produced by POLAR, GARMIN, and FIBRIT companies, but they have not received FDA approval. But the Apple Watch has received FDA approval. Currently, many research activities interrelated to Parkinson's are carried out. EVER Pharma has nowadays accepted the CE Mark and is launching the D-mine Pump in Europe. Wearable devices can catch a variety of physiological information to decide the health status of occupants in one or more vehicles. Like the blood rate pattern, these data can utilize to define a person in the device. Its methods include full or partial checks of the device according to the health status of the passengers.

1.3.1. Effects of Wearable Technology in Physical Medicine

In order to benefit from developments in telemedicine and information processing, there is a necessity for an efficient and mobile knowledge substructure or watching system that can be adapted to the needs of the separate. And if this information substructure can be implemented in the shape of a wearable garment that collects, processes, stores, and transmits (and receives) information about the user, it will go a long route.

- defining the health issue
- understanding the health system
- improving the way of life for all in the continuum of life throughout the continuum of care

One of the simplest examples of the utilization of wearable technologies in clinical applications is the measurement of motion and muscle activity by using accelerometers and accelerometers together with electromagnetic sensors. Accelerometer signals can be used to calculate position or speed; however, deviation from integration reduces data quality.

In a study on Parkinson's patients, motor complications and symptoms of patients and follow-up of recovery after stroke are followed using wearable technologies. Today, it is intended to combine wearable technology and minimal sensor technology with mobility aids. Wearable technology is important as it allows the implementation of closed-loop purposes that are advantageous for the rise in complication and elasticity that robotics contribute to the creation of orthoses, prosthetics, and mobility-assist instruments.

Similar practices have been followed to watch cardiovascular illness like congestive heart failure, which want long-term follow-up of patients to control setback in patient condition and possibly prevents hospitalization by activating emergency interventions. Holter monitors are a priceless tool for diagnosing cardiovascular disease in the last half century, it can be defended that the vision revealed by Holter monitoring can be fully implemented using wearable technology alone (Bonato, 2010).

1.3.2. Use of wearable Technologies in Hospital

In addition to home use, wireless health monitoring systems also provide convenience in the follow-up of patients in the hospital. Especially in state hospitals, where most of the patients are admitted, there may be staff shortages from time to time, which makes it difficult to follow up with the patients adequately. For this reason, wearable sensor technologies placed on textile surfaces make it easier to monitor the patient's condition in the emergency room or intensive care unit, thanks to wireless systems, and to access parameters such as pulse, respiration, body temperature, and position to the healthcare team.

Wearable technologies currently only find limited use in patient maintenance, but their use in hospitals is supposed to increase in the future. Today's wearables use a technology called PPG, which measures different reflections from light to record heart rate. In previous studies, there are studies showing that this technology accurately measures heart rate in outpatient treatment, but there is no study yet that this technology gives accurate results for inpatients.

Complications that may occur, especially in patients after surgery, may even lead to the death of the patient. For this reason, the patient should be followed up by monitoring the vital parameters after the surgery. The data obtained thanks to wearable technologies are transferred to a smartphone, from which doctors can monitor it. Any changes in these parameters are immediately notified to the hospital and health personnel.

1.3.3. Usage of Wearable Technologies for Elderly Peoples

While it is difficult to meet the needs of elderly people in developing countries and to follow up after illness or surgery, developed countries can

meet the needs of these people. The reason for this is that the economic conditions in developing countries cause insufficient monitoring of diseases, resulting in an increase in health problems and the inadequacy of elderly care centers. In cases where elderly care in the hospital environment is insufficient and not possible, home care option has emerged and wearable technologies have been used to provide this.

Especially in old age, the need for people to go to health institutions and to be followed by these institutions increases. For this reason, smartphones, wearable devices, and mobile imaging systems have increased their popularity in this field as well. In particular, the follow-up of people whose condition is critical in advanced ages is carried out in-home care methods or in a hospital environment. Mobile monitoring and care systems, designated as MMC, provide convenience to both those working in the health sector and those who take care of their parents in the home environment. Mobile monitoring and care systems, designated as MMC, provide convenience to both those working in the health sector and those who take care of their parents in the home environment.

The use of sensors and wearable technologies, especially in cases where health personnel are insufficient, helps doctors to monitor the patient remotely and inform the patient about health problems through methods such as video conferencing. One of the most important advantages of this system is that thanks to the remote vital signs monitoring sensors, doctors, nurses, and family members can have direct information about important changes in vital signs. In addition, with the help of sensors that measure heart rhythm, the doctor can determine whether patients with cardiovascular diseases require emergency intervention or not through these systems. In addition, since there are sleep-related problems in elderly people, these people can also be followed during sleep (Al-Shaki et al., 2016).



Figure 4. *Use of wearable Technologies in elderly people*
(<https://tomorrow.city/a/electronics-for-seniors>, date 20.12.2022)

1.4. Use of Wearable Technologies in Sport

One of the areas where wearable technologies are used in sports and athletes receive support from wearable technologies is to follow their training with a better monitoring system. Brands such as Catapult and STAT-Sports offer wearables for the sport of football, hockey, rugby, and baseball. Wearable products developed by these companies can provide indoor and outdoor localization and heart rate monitoring by offering small devices that are attached to special vest pockets on the back. With the help of these assistive devices, data is collected and analyzed, and situations that may cause injury can be avoided.

Smart wearable technologies in sports are included in this group of devices that help protect athletes against injuries. In general, the functions of monitoring functions such as body temperature, heart rate, and breathing in sports and other physiological parameters such as the number of steps taken and the total distance traveled can be obtained using smart devices attached in sportswear (Chika and Adekunle, 2017). The most popular devices used in the sports field of wearable technologies are the ones in the form of wristbands worn on the body, but there are also wearable smart textile products in which sensors are embedded.

One of the most important reasons for the utilization of wearable technologies in the field of sports is that performance measurements can be made without causing any disruption in the performance of athletes. In sports such as American football or Ice Hockey, sensors are embedded in pads placed on clothing. Football boots with sensors on their outsole are known to generate data that show the ball's maneuverability. Sensors can also be built into the sneakers to monitor how feet respond. The wearable design needs to be ergonomic enough to easily adapt to changes in the user's activity. Therefore flexible sensors can provide practicality for this use. Also, flexible sensors provide the opportunity for many wearable design innovations, but the accuracy of the processed data can only be evaluated when it makes sense based on consumer feedback.

Injury prevention is another reason why wearable technologies are used in sports. For example, providing auditory feedback to prevent a sports injury called a stress fracture while running may cause this problem to be less common. Fatigue is another risk factor that causes injury, and by monitoring the change in running mechanics during a marathon, injuries that may occur due to fatigue can be prevented (Adesida et al., 2019). Helten et al. (2011) classified trampoline jumps thanks to the wearable technology system named MTx IMU, which was designed using accelerometers, gyroscopes and magnetometers in the study. The movements made during this sports activity are classified according to the slope of the

limb, the closed angles between the limbs, and the angular velocity of the sensors throughout routine operations (Helten et al., 2011).

In another study, the throwing movements of baseball were investigated by means of two accelerometers and gyroscopic sensors attached to the upper and lower arms. Thus, it was stated that analyzing the biomechanics of the baseball shot can be made when the accelerometer and gyroscopic sensors detect the shot (Koda et al., 2010). Monitoring sports activities using an objective system is important for both athletes and coaches, in this way, the reactions of the athletes to the training can be followed individually. Brink et al. (2014) found a difference between the planned training load and the performed training load measured using wearable technology. This difference between coaches and athletes has also been seen in other sports such as judo, volleyball and tennis (Brink et al., 2014).

Especially when athletes will use wearable technologies and performance-enhancing technologies, they need more scientific evidence regarding these technologies. However, these technologies should not harm health of the athletes and should prioritize the health and safety of the athletes. In addition, it should be investigated whether there is scientific evidence about the devices. If scientific evidence is scarce, first trials should be conducted and recorded with these devices. The teachings about using GPS tracking are that time, rigor, and careful analysis are required before athletes and coaches can get truly meaningful data.

1.5. Wearable sensors and physiological signals to measure movement

A wearable kinesthetic system was defined to capture and classify upper extremity movement in post-stroke rehabilitation. Early studies on wearable technologies aimed to combine the sensors used with fabrics and wireless technology. Today, studies have focused on the development of sensing elements that can be placed more easily on clothing (Bonato, 2005). The sensors, which are defined as hybrid sensors, can be used to examine the quality of movement especially in order to detect motor disorders. Thus, as a result of measuring both movement and muscle systems, dysfunctions can be followed. Also, accelerometers and EMG recording systems were used for the measurement of movement.

A new foam-based pressure sensor for wearable sensing was developed and neck movements and scapular pressure were measured. It summarizes the positive preliminary results of the aiming research team (Dunne et al., 2005). New methods have been developed to correct the measure of heart rate and oxygen saturation.

1.5.1. Biosensors

Biosensors can be used in various forms such as hats, shirts, rings, belts, bracelets, shoes, socks, eyeglasses, contact lenses, necklaces, and watches (Ajami and Teimouri, 2017). Biosensors are sensors that are produced to interact with a specific substance, and the result of the interaction can be considered as a receptor or stimulus as messages can be analyzed by a microprocessor. Sensor-based communication systems can monitor, stimulate, treat or modify human biophysical performance. therefore biosensors consist of a bioreactor, transducer, and output system. Such devices were originally developed for home in vitro measurements such as blood glucose. These biosensors are auxiliary devices in the monitoring, diagnosis, and treatment of diseases, and these biosensors enable to be watching of life symptoms of patients, athletes, premature babies, children, psychiatric patients, patients in the necessity of longtime nutrition, patients in remote areas far away to health and medical services.

1.5.2. Telemedicine sensors

Telemedicine, wearable technologies group's remote health monitoring and it is a branch that provides social care. Thanks to this technology, independent living, better living conditions, diagnosis, and treatment opportunities can be provided. The dimensions of these sensors made of silicon are 2×2 millimeter chips. These systems, defined as chips, are made from a thermal thermocouple and a narrow lithium battery. In the applications, blood pressure, heart rate, body temperature, and blood oxygen grade were measured. With help of this sensor, it is aimed to view body movements and transmit obtained information to the health center. Telemedicine technology will become cheaper over time and it will be used by more people thanks to the advantages it provides. The biggest advantages of this technology are portability, good user interface, and not disrupting one's daily routine.

1.5.3. Microsensors

Sensor systems defined as microsensors consist of existing inertial measurement units (IMUs) such as gyroscopes and magnetometers, microelectromechanical sensors (MEMS), or a combination of these sensors (Ometov et al., 2021). There are GPS systems with IMUs that can be examples of these systems. These systems connect to the athlete during training, facilitating real-time detailed motion examination and providing a labor-intensive alternative to video encoding. Microsensors contain IMU systems to track specific strokes and specific movements during training and competition in sports such as tennis. Ghasemzadeh et al. (2011) used microsensors with 30 Hz measurement capacity to examine wrist injuries that occur during golf sports matches (Ghasemzadeh et al., 2011).

1.6. Wearable Technologies Application examples

Life jacket:

These garments, which are defined as life jackets, monitor the pulse and blood pressure of the patient wearing the life jacket. Thanks to the system embedded in the jacket, the data gathered by the instrument are sent to a computer that a medical professional can read. This life jacket is used to measure Uncuffed BP through arterial tonometry and radial pulse waveform. Data on Parkinson's patients were collected using this technology, which was described as a life jacket in previous studies. Di Rienzo et al. (2005) mentioned a system that measures the heart and respiratory rate in working and resting states and transfers the data to the life jacket in order to monitor the patients leaving the hospital (Di Rienzo et al., 2005).

Life Vest Belt

It is an abdominal device system used for the follow-up of pregnant women, which enables the follow-up of both the mother and the fetus during the pregnancy process. It provides the follow-up of pregnant women, especially in cases where access to the health system is difficult. Thanks to this system, the information received from the mother and fetus is sent to a computer that a medical professional can evaluate and treat according to taken information. In addition, it is a system especially needed by obstetricians as it collects and collects data on a regular basis. In a study, a life belt containing temperature sensors, respiratory sensors, and accelerometers was mentioned and it was stated that this system would be used for the follow-up of patients staying in nursing homes.

Sensory baby vest and socks

Infant deaths due to suffocation during sleep are still an important health condition that needs attention today, but this situation can be prevented thanks to a baby vest produced by Denkendorf. This vest allows the monitoring of staminal organs such as the heart, skin, and lungs. However, body temperature is an important parameter, especially in terms of child health, and this vest can be used in the diagnosis of heart diseases by monitoring body temperature. In addition, heart rate, oxygen level, body temperature, and sleep quality can be measured thanks to the smart sock technologies called Owlet.

There are also systems that mothers can use to monitor their babies. Thanks to these wireless systems and sensor technologies, breathing, body temperature, and activity status can be monitored. These systems are compatible with smartphone technologies and require Android systems to be installed on the phone.

Smart Shoes

As a result of a study by the University of Utah, smart insoles were designed using sensor systems to correct movement abnormalities and people's walking behaviors. Thanks to this system, movement abnormalities in people with foot fractures, hip joint replacement, or artificial legs have been resolved to a great extent. The information taken from the smart insole can be viewed on users' smartphones wirelessly and with aid of software. Intelligent running shoes designed by Nike consist of a unique sensor system that enables tracing the motion of athletes while running and transfers the data wearable to technology devices such as personal iPods. Thanks to this system, data such as running speed and total distance can be tracked.

CONCLUSION

Today, clothes do not only provide thermal comfort, tactile comfort, and body movement comfort, or they have ceased to have aesthetic features such as fashion and smart systems that can monitor our vital signs (such as heart rhythm and breathing) have also started to take place in our clothes. With the help of these systems, which are also defined as wearable technology, the movement and vital signs of patients, elderly people and athletes can be followed. Thus, it has become easier to follow the patients in the hospital environment, and it has become easier to follow up on the health of the elderly living alone and in areas far from the health system. In addition, athletes' movements, training data, and even movements that may cause injury have become controllable by means of microsensors placed on sportswear. In addition, infant deaths can be prevented thanks to T-shirt or vest systems that allow monitoring organs that monitor vital data such as the lungs, heart, and skin of babies. In this study, what the definition of wearable technology covers, its historical development, and different uses of wearable technologies on the body and in clothing are mentioned. In addition, the use of wearable technologies in hospitals, elderly people and sports areas is declared. Also, the sensor systems used in wearable technologies and the measured vital signs are mentioned. As a result, the literature on this topic, which is still up-to-date, has been contributed and information has been given about the new generation of smart clothing technologies.

REFERENCES

- Adesida, Y., Papi, E., & McGregor, A. H. (2019). Exploring the role of wearable technology in sport kinematics and kinetics: A systematic review. *Sensors*, 19(7), 1597.
- Al-Shaqi, R., Mourshed, M., & Rezgui, Y. (2016). Progress in ambient assisted systems for independent living by the elderly. *SpringerPlus*, 5(1), 1-20.
- Ajami, S., & Teimouri, F. (2015). Features and application of wearable biosensors in medical care. *Journal of research in medical sciences: the official journal of Isfahan University of Medical Sciences*, 20(12), 1208.
- Bonato, P. (2005). Advances in wearable technology and applications in physical medicine and rehabilitation. *Journal of neuroengineering and rehabilitation*, 2(1), 1-4.
- Brink, M. S., Frencken, W. G., Jordet, G., & Lemmink, K. A. (2014). Coaches' and players' perceptions of training dose: not a perfect match. *International journal of sports physiology and performance*, 9(3), 497-502.
- Chika, Y. B., & Adekunle, S. A. (2017). Smart Fabrics-Wearable Technology. *Int. J. Eng. Technol. Manag. Res*, 4(10), 78-98.
- Di Rienzo, M., Rizzo, F., Parati, G., Ferratini, M., Brambilla, G., & Castiglioni, P. (2005, September). A textile-based wearable system for vital sign monitoring: applicability in cardiac patients. In *Computers in Cardiology, 2005* (pp. 699-701). IEEE.
- Dunne, L. E., Brady, S., Smyth, B., & Diamond, D. (2005). Initial development and testing of a novel foam-based pressure sensor for wearable sensing. *Journal of neuroengineering and rehabilitation*, 2(1), 1-7.
- Erdmier, C., Hatcher, J., & Lee, M. (2016). Wearable device implications in the healthcare industry. *Journal of medical engineering & technology*, 40(4), 141-148.
- Ghasemzadeh, H., Loseu, V., & Jafari, R. (2009). Wearable coach for sport training: A quantitative model to evaluate wrist-rotation in golf. *Journal of Ambient Intelligence and Smart Environments*, 1(2), 173-184.
- Helten, T., Brock, H., Müller, M., & Seidel, H. P. (2011). Classification of trampolining jumps using inertial sensors. *Sports Engineering*, 14(2), 155-164.
- Koda, H., Sagawa, K., Kuroshima, K., Tsukamoto, T., Urita, K., & Ishibashi, Y. (2010). 3D measurement of forearm and upper arm during throwing motion using body mounted sensor. *Journal of Advanced Mechanical Design, Systems, and Manufacturing*, 4(1), 167-178.
- Kroll, R. R., Boyd, J. G., & Maslove, D. M. (2016). Accuracy of a wrist-worn wearable device for monitoring heart rates in hospital inpatients: a prospective observational study. *Journal of medical Internet research*, 18(9), e6025.

- Ometov, A., Shubina, V., Klus, L., Skibińska, J., Saafi, S., Pascacio, P., ... & Lohan, E. S. (2021). A survey on wearable technology: History, state-of-the-art and current challenges. *Computer Networks*, 193, 108074.
- Randazzo, V., Pasero, E., & Navaretti, S. (2018, March). VITAL-ECG: A portable wearable hospital. In *2018 IEEE Sensors Applications Symposium (SAS)* (pp. 1-6). IEEE.
- Sharma, A., Singh, A., Gupta, V., & Arya, S. (2022). Advancements and future prospects of wearable sensing technology for healthcare applications. *Sensors & Diagnostics*, 1(3), 387-404.
- Shirer, M., Ubrani, J., LLAMAS, R. (2015). IDC Forecasts Worldwide Shipments of Wearables to Surpass 200 Million in 2019, Driven by Strong Smart-watch Growth International Data Corporation (IDC).
- Srizongkham, S., Shirahada, K., & Chiadamrong, N. (2018, August). Critical factors for adoption of wearable technology for the elderly: case study of Thailand. In *2018 Portland International Conference on Management of Engineering and Technology (PICMET)* (pp. 1-9). IEEE.
- Qiu, H., Wang, X., & Xie, F. (2017, November). A survey on smart wearables in the application of fitness. In *2017 IEEE 15th Intl Conf on Dependable, Autonomous and Secure Computing, 15th Intl Conf on Pervasive Intelligence and Computing, 3rd Intl Conf on Big Data Intelligence and Computing and Cyber Science and Technology Congress (DASC/PiCom/DataCom/Cyber-SciTech)* (pp. 303-307). IEEE.
- Url-1 < “What Operating Systems Do Wearable Devices Run On?,” MakeUseOf. [Online]. Available:
<http://www.makeuseof.com/tag/whatoperating-systems-do-wearable-devices-run-on/>>, date retrieved 20.12.2022.

“

Chapter 2

**POLYMERS USED IN THE TEXTILE
COATING INDUSTRY, THEIR
APPLICATIONS AND THEIR EFFECTS
ON HUMAN HEALTH¹**

Aslhan KORUYUCU²

”

1 To cite this article: Koruyucu A.,(2022).Polymers Used in The Textile Coating Industry,Their Applications And Their Effects on Human Health

2 Dr.Öğretim Üyesi Namık Kemal University, Faculty of Engineering, Textile Engineering Department, Tekirdag/ Turkey adelituna@nku.edu.tr, orcid.org/0000-0002-8443-5188

1. INTRODUCTION

With the developments in the textile coating industry, products with unlike properties and unlike field areas are obtained. Although polymers have different properties, they are important materials in human life.

In order to protect textile materials from external factors, substances such as oil and wax are transferred onto the fabric and a fabric coated with restricted permeability properties is obtained.

Chemicals in liquid, paste or powder form a film layer on the fabric by transferring onto the textile material surface.

Waterproofing, heat partition and aesthetic appearance properties can be given to textile materials by polymer coating.

Most of the coating materials are long link linear thermoplastic polymers. The properties of these polymers affect the durability and efficiency of the obtained product.

The most employed polymers in coating in the textile industry include polyvinylchloride (PVC), polyurethane (PU), natural and synthetic rubbers, polyvinyl acetate (PVA), silicone, polytetrafluoroethylene (PTFE, Teflon), polyvinylidenechloride (PVDC), ethylene vinyl acetate (EVA), acrylic and polyolefin.

1.1. Chemical Structures and Properties of Polymers

a) Polyvinyl chloride (PVC)

Basic unit of polyvinyl chloride is $\text{CH}_2 = \text{CHCl}$ (Parys, M.V., 1994). A polar molecule such as polyvinyl chloride is appealed to each other by dipole-dipole interactions. The reaction depends on the electrostatic attraction of a chloride atom in one molecule to a hydrogen atom in other molecule. The London forces are characteristically inefficient than the dipole-dipole forces. That forces are displayed in PVC compounds. Polyvinylchloride (PVC) is a thermoplastic polymer (Krzysztof, L and Katarzyna, S., 2022). PVC can be rigid or flexible. Its' characteristic properties are comparatively precise to heat and light, fire enduring; enduring to chemicals, insects, fungi and humidity. PVC coatings are relatively well enduring to acids and alkalis, but chemical solvents can extract the plasticizer, leading to embrittlement and cracking. The advantage of PVC is upper dipole moment and dielectric stable (Seymour, R. and Charles, E., 1981).

b) Polyurethanes (PUR)

The polyurethane polymers are characterised by the urethane linkage (-CONH-). The basic constituents of PUR are polyols (polyester and polyether) and diisocyanates (aromatic or aliphatic). PUR can be utilized in the

form of a solution, a dispersion or as 100% solid and fluid and as pastes.

The addition reaction of a diisocyanate and a diol produces urethane macromolecule. The principal parts are polyols and polyisocyanates. The polyols are principally responsible for the cold and heat hindrance and the hydrolysis stability. There are two principal types such as polyester-PUR and polyether-PUR. Characteristic properties are excellent solvent hindrance, good adherence-hindrance, low specific weight, excellent strength and hindrance to tearing and abrasion. PUR dispersions are aliphatic and show excellent light fastness properties. Thickeners are necessary for good coating practices (Parys, M.V., 1994). And also, the advantage of PU is their flexibility and enduring to abrasion and water or solvents (Parys, M.V., 1994).

c) Natural Rubbers

Principal unit of natural rubbers is $\text{CH}_2=\text{C}(\text{CH}_3)-\text{CH}=\text{CH}_2$. Vulcanised natural rubber shows good tensile strength, flexibility and improved hindrance to temperature changes. Reinforced vulcanisates show increased tear strength and abrasion hindrance than unfilled or non reinforced vulcanisates. Vulcanised rubber is essentially insoluble in overall organic liquids, highly swollen in chlorinated solvents. The molecular structure of vulcanized rubber decomposes in upper boiling point substances. They are comparatively unaffected by alcohol, acetone and diluted acids and alkali. Electrical properties are greatly influenced by composition, conditions of vulcanisation, ageing, temperature, humidity (Parys, M.V., 1994). Natural rubber is a naturally occurring polymer. The presence of pendant methyl groups contribute to the flexibility of the natural rubber molecule (Seymour, R. and Charles, E., 1981). The long-range elasticity of rubber is dependent on the absence of strong inter-molecular forces. Natural rubber elastomers are available in latex form (Seymour, R. and Charles, E., 1981).

d) Butyl Rubber (HR)

Butyl rubber is natural rubber. It shows greater hindrance to heat ageing, oxidation, ozone-cracking, chemical attack such as water, salt solutions, alkalis (including NaOH and NH_4OH), inorganic acids.

Basic unit of butyl rubbers is $\text{CH}_2-\text{C}(\text{CH}_3)=\text{CH}-\text{CH}_2$ (Parys, M.V., 1994). This copolymer contains mostly isolated double bonds which assure a low cross-linked density and therefore the formation (Seymour, R. and Charles, E., 1981). Characteristic properties include good chemical inaction, low gas permeability (Parys, M.V., 1994), upper viscoelastic impedance, less oxidative aging, favorably ozone enduring than natural rubber and good solvent enduring (Seymour, R. and Charles, E., 1981).

e) Nitrile Rubber (NBR, acrylonitrile-butadiene copolymers)

In manufacture of nitrile rubber (NBR), acrylonitrile ($\text{CH}_2=\text{CHCN}$) and butadiene ($\text{CH}_2=\text{CH}-\text{CH}=\text{CH}_2$) are emulsified in water and then polymerized. Nitrile rubber has improved endurance to chemical and organic fluids. This polymer is swollen to some extent in butyl alcohol, phenols and diethyl ether (Parys, M.V., 1994).

f) Polychloroprene (CR, Neoprene)

Polychloroprene is natural rubber. It has superior endurance to heat, ozone and oils. Polychloroprene is plasticized by petroleum oils and especially aromatic types, esters (butyl oleate, di-octyl sebacate)

(Parys, M.V., 1994). Characteristic properties are flame enduring, self-extinguishing as a consequence of upper chlorine content, leading oil and chemical enduring, upper tensile impedance, good ozone and weathering enduring, leading resistance to oxidative degradation and aging (Seymour, R. and Charles, E., 1981).

This polymer have self-extinguishing properties owing to high chlorine content. It can be improved by adding mineral fillers such as antimony trioxide, zinc borate, tritoyl phosphate or chlorinated paraffins (Parys, M.V., 1994). This polymer's dynamic properties are greater than those of most synthetic rubber and slightly lesser to those of natural rubber (Seymour, R. and Charles, E., 1981).

g) Chlorosulphonated polyethylene (CSM, Hypalon)

This polymer has a comparatively poor low-temperature enduring (Parys, M.V., 1994).

h) Polytetrafluoroethylene (PTFE, Teflon)

PTFE have excellent electrical characteristics together with exceptional chemical inertness and excellent thermal enduring and withstanding temperatures. Basic unit of this polymer is $(\text{C}_2\text{F}_4)_n$.

(Parys, M.V., 1994). Characteristic properties include insolubility in most solvents, chemically inert, low dielectric loss, nonadhesive, low friction, constant electrical and mechanical properties from 20 to approximately 250°C, upper impact impedance and leading mechanical properties (Seymour, R. and Charles, E., 1981).

i) Polyvinyl fluoride (PVF)

This polymer has slightly lower chemical and heat enduring (Parys, M.V., 1994).

i) Polyvinylacetate (PVAC)

PVAC is a thermoplastic substance. It is available in several grades, ranging from soft and brittle to hard and tough, depending on the molecular mass. Molecular formula is $(C_4H_6O_2)_n$. PVAC is dissolved by aromatic and chlorinated hydrocarbons, ketones, lower alcohols and esters. It possesses general durability and enduring to abrasion is good and increases with molecular weight (Parys, M.V., 1994).

j) Polyolefins (PE, PP)

Polyethylene is a comparatively soft polymer. There are two principal types. These are the low density and the harder upper density polymers. Basic unit is $-CH_2-CH_2-$. Characteristic properties are hydrophobicity, low moisture region, comparatively unaffected by polar solvents, water, alkali and acids at room temperature and excellent electrical isolators (Parys, M.V., 1994).

Polypropylene is a linear hydrocarbon. The methyl group is attached isotactically. Its basic unit is $CH_2=CHCH_3$. Characteristic properties are low moisture region, swollen by aromatic hydrocarbons, comparatively unaffected by numerous organic liquids at room temperature and aqueous solutions including acids and alkali and comparatively soft (Parys, M.V., 1994).

k) Ethylene/vinyl acetate copolymers (EVA)

This polymer has a wide variety of physical and mechanical properties. Vinyl acetate is more polar than PE. This causes a change in its solubility. They are principally employed as hot-melts. The durability and stability properties are favorable than plasticized PVC. The melt temperature of EVA-based hot melts is often increased in order to enhance adherence (Parys, M.V., 1994). Vinyl acetate copolymers are produced by the oxidative condensation of acetic acid and ethylene (Seymour, R. and Charles, E., 1981).

l) Polyacrylates and polymethacrylates

Typical properties are softness, resiliency, low UV degradation, high endurance to natural ageing, favourable cost, reduced flexibility endurance at low temperatures, blocking effect and low flammability properties. These polymers can be employed as organosols or water-based dispersions. Basic unit is $(CH_2-CR(COOR'))$ $R=H, CH_3$, in which R' =alkyl (Parys, M.V., 1994).

m) Silicones

Silicone polymer's fundamental unit is $O-Si-O-$. From the chemical standpoint the siloxanes fall into three groups such as dimethyl polysiloxanes, modified methyl polysiloxanes and dihydroxydimethyl polysiloxanes (Parys,

M.V.,1994). Characteristic properties are chemical durability, mechanical and thermal behaviour, hydrophobic properties, good washing fastness, ageing hindrance to oxidation and micro-organisms, elasticity, exceptional feel and comparatively good water vapour permeability(Parys, M.V.,1994).

1.2. The Usage of Polymers and Their Fields of Application

Polyvinyl chloride (PVC) is usually incorporated into color pigments, flame retardant agents and numerous other special compounding ingredients. It has similar properties, which is employed to accomplish a nonflammable effect in the cause of the higher price. The main applications of **PVC** polymers are synthetic leather, raincoats, technical clothing and headlining (Parys, M.,1994). They can be employed as weather protection at door areas (Krüger,2009), translucent roof tiles, pipes, connections for water, in the construction industry principally as window and door profiles, floor lining and roof membranes (Cousins,2002). It is extensively employed in medical devices (Janajreh vd.,2015; Luciani vd.,2015) and in overall kinds of inhibitive fabric coating (Xie,2017).

PU-based coatings for FR practices are mostly utilized in the area of bindings, foams, textiles, membranes, elastomers. And also they are usually utilized in metalline layers, car upholstery, thermal partition in waterproof clothing, casing, coatings, films, belts and frames (Romaskevicius vd., 2006).

The **natural rubbers** were utilized as film formers in pharmaceutical coatings (Panrat vd.,2012). They provide perfect physical properties such as upper elasticity and upper tensile strength (Jianprasert vd.,2015). The utilization of **natural rubber** provides low water affinity and low absorption rates of the coated surfaces (Wang vd., 2008).

Butyl rubber materials are also employed as chemical agent protective clothing applications (Fusco and Hous.,1987).

Nitrile rubber (NBR) is mostly employed to make hoses, seals, gloves and numerous other industrial products (Bergstram, 2015). On the industrial adverse, **NBR(nitrile rubber)** performs in roll covers, hydraulic hoses, conveyor belting, oil area packers, seals for overall kinds of plumbing and contraption practices (Kanny and Mohan,2017). **NBR** is an perfect material in a lot of practices as a consequence of its upper energy absorbing characteristics, upper flexibility, perfect puncture, tear-hindrance and good adherence to fabrics (Van Baarle, 2003). Therefore, **NBR(nitrile rubber)** has been extensively employed as tires and coated fabrics in several technical textile practices (Wootton, 2001; Fung, 2002).

Polychloroprene rubber is usually performed in contact bindings. Contact bond is employed on permeable surfaces, such as textiles (Troughton, 2008).

Chlorosulphonated polyethylene coatings are used in numerous sectors. They also provide hindrance to oils, chemicals, solvents and weathering. They are employed in practices such as swellables in boats, life rafts, fuel bladders and further swellable constructions (EREZ Tech. Text, 2019 ; EREZ Tech. Text ,2020).

Polytetrafluoroethylene fibers can be performed in fabricating heat insulating clothes as a consequence of their low thermal conductivity. And also they can be employed in fabricating inhibitive clothing. They provide perfect thermal stability and chemical hindrance (Feiring ,1994).

PVDF(polyvinylfluoride) has been implemented in membrane materials (Deshmukh and Li,1998). PVDF membranes have been employed for proton conduction (Flint and Slade,1997 ; Jacob vd.,1997 ;Ostrouskii vd.,1997), gas eliminate, disintegration and biological practices (Cornelissen vd.,1998; Schielen vd., 1995 ; Tarlton and Knight, 1996 ; Zhai vd., 2003).

Polyvinyl acetate(PVAC) have been employed as anti-dust treatments for concrete floors (Shaw,2001). **PVAC** bindings and copolymers are also employed as holt-melt bindings, spackles, in fabric finishing, plastic wood and inks (Kaboorani and Riedl , 2015).

Polyolefin fibers (PE and PP) have been employed in sportswear and inhibitive clothing (Yong and Kim, 2017).**PP** is a basic material which is used for a variety of applications including films, fibers, tapes, sheets, thermoforms, injections, molding. It has excellent physical properties (Maddah, 2016).

The potential for use of **ethylene/vinyl acetate copolymers (EVA)** is in controlled drug delivery systems (Schneider vd., 2017). **EVA copolymers** may have great potential practices in smart textiles, flexible actuators and artificial muscles (Xiaoming vd.,2019).

The acrylate and methacrylate polymers are significant in a prevalent variety of practices. They are employed in textile sizing, in special bindings, lacquers and as oil compounding ingredients (Calvin vd., 1959).

In the textile industry, **silicones** are performed in whole phases of the development, on the fiber production, on the fabric or guideline and on the finished goods. Silicones are utilized from unlike distribution systems to supply numerous advantages as lubrication, softening, foam control or hydrophobic coatings (Lenoble, 2001). **Silicones** find practice in various markets, such as aerospace, automotive, construction, electronics, medical materials, performance chemicals, coatings, personal care, paper and textile (Smart and Takei,1993). Silicones can be performed for a prevalent range of practices. They are used in heat-resistant clothing, weather-proof

tents, conveyor belts for food produce, non-slip garters, building shading, airbags, flame-retardant clothing and architectural membranes, UV-stable activities and non-slip socks.

1.3.The Usage of Polymers In Coating of Textile Materials and Some Related Studies

There are numerous studies on the use of polymers in the coating of textile materials. The papers obtained from the literature review were summarized:

Chen et al.(2014) have examined that the anisotropic behaviour of **PVC**-coated PE fabrics under low tensile underline. Test specimens were uniaxial and biaxial women fabrics of **PVC**-coated PE.

Zhao et al.(2008) have studied that upper-capacity oil sorbent **PVC**/ polystyrene(**PS**) fibers. The fibers were fabricated by the electrospinning development. As a consequence of perfect mechanical properties and water/oil repulsion, **PVC** can act as a fundamental option to several synthetic textile fibers.

Xinrong et al.(2014) have investigated the use of low molecular weight of chitosan as employed to prolong the **PU** prepolymer link for the preparing of chitosan–**PU** dispersion. This dispersion was used to unlike quality smooth weave poly-cotton dyed. It was on printed fabric parts to acquire enhanced rigidness, pilling hindrance and favorably mechanical characteristics. It was recommended that the quality of raw cotton and woolen fabrics can also be enhanced by using this technique.

Benthem et al.(2000) have explored that synthesized hyper branched **PU** polymers. They cannot resist fire as they are non-flame inhibitors. To alter these hyper branched materials for sure flame-retardant coating practices, compounds incorporating nitrogen, halogen or phosphorus may be introduced into them.

Liu et al. (2019) have researched the security of asphalt pavements with an original altered **PU** coating. The aim was to get ready conductor **PU** based powder obvious coatings altered with multi barrier carbon nanotubes (**MWCNT**). The acquired results pointed that the water contact angle, electrical conductivity and the corrosion hindrance of the **PU** coating were enhanced by the **MWCNTs** addition.

Sultan et al.(2019) have researched the soft segment size of **polyurethane** dispersion with the physiochemical and antimicrobial characteristics for textile practices.

Sun et al.(2020) have researched the conductor composite yarns.The micro construction and in connection effect factors on the mechanical fea-

ture as well as form memory behaviour overall have been defined. A tolerant, upper-hindrance, conductor form memory composite fabric attributed constant carbon fiber/**polyurethane** yarn.

Dai et al.(2021) have investigated the coated hydrophobic textile surfaces. Hydrophobic textile surfaces have perfect electromagnetic shielding efficiency and low reflectivity in advanced EMI shielding practices. A green attitude to preparing hydrophobic, electrically conductor textiles attributed waterborne **polyurethane** for electromagnetic meddling shielding with low reflectivity.

Hasan et al.(2021) have researched into **PU**s and their derivatives, synthesizing protocols, chemistry, characteristics, various FRs and related technologies.

Matkovic et al.(2013) have studied that the elongation features of **polyurethane** coated knitted fabrics. In this study, they have calculated polyurethane coated knitted fabrics' elongation features by using the regression models.

Schwarz et al.(2014) have examined that the influence of different warp densities on physical-mechanical features of **polyurethane** coated fabrics.

Mertgenç et al.(2021) have investigated that the **polyurethane polymers** applied to fragranced cotton, polyester and silk textiles.

Gersak (2013) has examined that the thermoplastic material coated textiles such as polyvinylchloride (**PVC**) or polyurethane(**PU**) coated textile fabrics and laminated products (component **polyurethane/PTFE** polymer blend).

Shah et al.(2012) have investigated that the presence of holes in the **rubber** material attached to actinomycete colonies in both liquid mineral culture and agar plates covered with NR films.

Dalal M. (2021) has researched the effect of incorporating diversified contents and **rubber** of treated clay on the mechanical features of the prepared nanocomposites.

Padhiyar et al.(2022) have investigated that the hindrance, strength and durability of the blending **rubbers** with polyester waste fabric.

Mandlekar et al.(2021) have investigated that the **natural and butyl rubber** elastomers played a significant role in the development of inflatable structures owing to their weatherability, UV and ozone hindrance and stability against oxidation. The aim of this study was the use of special elastomers to improve the swelling structure.

Geng et al.(2021) have studied that the sodium salt of styrene maleic anhydride copolymer **rubber** were applied to the non-woven functional thermochromic textile material with the thermochromic PCM mixing method.

Lin X et al.(2020) have studied that **synthetic rubber** materials that were extensively employed in industry, national defense, transportation and daily life. Upper-efficiency and functional synthetic rubber was the key advanced base material necessary for the development of the new area.

Lee and Kim(2014) have designed that the attachable golf twist prototype **neoprene** fabric to evaluate elbow motion. This study provided valuable information for the smart fashion industry.

Pereira et al.(2007) have designed and developed that the new spacer fabrics for trade products such as **neoprene** and knitted fabrics containing composite materials. In this study, new products, raw materials, constructions and finishing processes applied to them were emphasized.

Srivastava et al.(2011) have studied that textile wastewater, **polyvinylidene fluoride(PVDF)**, ultrafiltration (UF)membranes as a pretreatment for reuse. In this study, **PVDF** membranes were used for disintegration of dye solutions, elimination of soft color and reduction of chemical oxygen index(COD).

Pionteck and Wypych (2017) have investigated that the production of flexible intermediate bulk containers containing **PVC, EVA, PE, PP** and their liners. In addition, the feasibility of metal and carbon fibers and energy consuming rubberized fabrics were assessed.

Ingarao et al.(2017) have investigated that the **PP** as a packaging material had lower global warming potential (GWP). In this study, the global warming potential was corresponding to 1.95 kg CO₂ equivalent.

Yin et al.(2016) have emphasized that industrial recycled **PP** fiber had better environmental carbon emission performance than unprocessed **PP** fiber.

Tuladhar R and Yin (2019) have investigated that the carbon emissions of recycled **PP** macrofibers were 50% lesser than that of untreated **PP** and the water-fossil fuel consumptive were reduced by 99% and 91%, respectively.

Bora et al.(2020) have emphasized that the chemical recycling processes of **PP** illustrated lower environmental impacts than the incineration and mechanical recycling.

Antelava et al.(2019) have researched that the pyrolysis process of **PP** provided more environmental benefits than thermochemical processes.

Galve et al.(2021) have investigated that the recycled **PP** could reduce its carbon footprints by 42.8% compared to untreated PP.

Beigbeder et al.(2019) have investigated that the energy cure of **PP** composites showed better results than storage options.

Al-Eijii and Al-Qahtani (2021) have studied that the **PP** composites containing wood flour illustrated better environmental results than glass fibers.

Tsuruta et al.(1969) and **El-Aaser et al.(1982)** have examined the employment of **vinyl acetate**-based emulsions were employed in nonwovens and some specialty coatings.

Elesini et al.(2017) have investigated the **polyacrylate** polymers employed in fragranced textiles with male and female fragrance oils.

Guignier et al. (2019) have applied the **polymethylmethacrylate (PMMA)** polymer to knitted fabrics as socks by immersion method.

Zhang et al.(2021) have applied that the **polymethyl methacrylate(PMMA)**, polydimethyl siloxane (**PDMs**) and poly(dimethyl-siloxane)-graft- **polyacrylates(PDMS-PAA)** polymers to cotton socks.

Mazzon et al. (2019) have investigated the hydrophobicity of **silicones**. Primarily,the stable micro-emulsions such as an aqueous dispersion of isopropyl alcohol and polycarbonate diol are prepared and employed as fabric softener.

Liu et al.(2015) have assessed that the **tetraethoxy-silane-TEOS** polymers employed in thermo-regulated cotton fabrics by sol-gel technique with pad-dry cure method.

Dogan et al.(2017) have investigated that the **silicon dioxide** reinforcement enhanced the dyeability, abrasion hindrance, water repellency and soil repellency.

2.Effects of Polymers Used In Textile Coating Industry On Human Health

Poly(vinyl chloride) (PVC) polymer materials have damaging properties against the ecological environment. Normally the pthalates are used to make PVC flexible, which is harmful to the human body. PVC contains many poisonous chemical substances such as BPA, phthalates, lead, dioxin and cadmium. The PVC polymers disposable to severe health risks and environmental contamination. For this reason, PVC use has reduced significantly(Proshad vd.,2018).

The monomers of **PU**s negatively affect environmental and health effects owing to the presence of phosgene. The PU polymers contain dangerous

materials such as phosphate, glycols, and amines that might be dangerous to the respiratory tract, skin systems, and the environment (Adetunji *vd.*, 2021).

Various **rubber** compounds contain the major volatile component such as tetramethyl thiuram disulfide and carbon di sulfide. These components have adverse effect on human health especially the respiratory system of human (Chaiear, N., 2001).

When **Butyl Rubber polymers** contain polycyclic aromatic hydrocarbons (PAHs), bio accumulate they have poisonous, mutagenic and carcinogenic effects on living organisms in the aquatic ecosystem (Kumar *et al.*, 2016). They also have significant health risks for human health (Kallenborn *et al.* 2012; Venkatesan and Halden 2014; Rengarajan *et al.*, 2015).

Nitrile rubber polymers which are used as gloves. Nitrile gloves can effectively protect against viral infections and various chemicals. And also, they have physical barrier to these hazards, especially as a viable alternative to natural latex exam gloves (Rego, A., and Roley, L., 1999); (Edlich *et al.*, 1999); (Jackson *et al.*, 1999).

Polychloroprene affects the circulatory system and immune system. It depresses the central nervous system (CNS), irritates the skin and mucous membranes and causes dermatitis and respiratory difficulties in humans. In rats, it causes inflammation of the mucous membranes. In addition, it causes damage to the lungs, liver, spleen and kidneys (Environmental Protection Agency (EPA), 2012).

High concentrations of **polytetrafluoroethylene** cause irritation to eyes, nose and throat (World Health Organization, 2004). As a result of overheating of polytetrafluoroethylene, poisonous gases are released. It causes serious damage to the respiratory tract of humans. Polytetrafluoroethylene is about 10 times more poisonous than phosgenes. Inhalation of this gas causes pulmonary edema which can be fatal (Patocka and Bajgar, 2009). Inhalation of polytetrafluoroethylene gas damages the lungs (Johnston *vd.*, 2000). PTFE is less harmful to rats (Radulovic and Wojcinski, 2014). PTFE does not cause antibody production when it enters the human body. This corresponds to twenty times. It does not harm the immune system (Kim *vd.*, 2013). Inhalation of the pyrolysis products of PTFE causes serious poisonous effects (Johnson, 2018a). PTFE has potentially adverse health effects (Lohmann *vd.*, 2020).

Polyvinyl fluoride polymers can pose a variety of environmental and human health risks throughout their lifecycle (Gebreab *vd.*, 2020; Rice *vd.*, 2021). **PVF** has ecologically poisonous and dangerous features. Therefore, it may pose a risk to humans and the environment (Wang *vd.*, 2015).

Vinyl acetate polymer causes eye and nose irritation. This corresponds to 10-22 ppm or 35-77 mg/m² (EPA,1997). And also it may affect the heart, nervous system and liver . It may cause skin irritation (United States National Institute for Occupational Safety and Health,1978).**Vinyl acetate (PVAC)** is rapidly metabolized by esterase in human blood and animal tissues. It causes chronic disease in the lungs through inhalation (Clary, 1998).The short-term contact concentration of **polyvinyl acetate (PVAC)** from carpets is 1mg/m³. Long-term exposure to a concentration of 0.036 mg/m³ corresponds to 9.2 µg/kg body weight for men, 4.6 µg/kg body weight for women and 18 µg/kg body weight for children. The dermal effect of vinyl acetate corresponds to approximately 1µg/kg body weight/day. According to EU criteria, vinyl acetate has no acute oral and acute dermal effects. However, the maximum inhalation time has an LC50 value of 15.8 mg/l for 4 hours. This value corresponds to 14.1 mg/l for 4 hours in rats. This requires labeling with R20 and is also harmful by inhalation (Vinyl Acetate Summary Risk Assessment Report,2008).

Polyethylene (PE) polymers do not harm the human body. They can be used in food and beverages (Meeker, 2009).

PP is both a thermoplastic and an environmentally friendly polymer (Neissi and Ledwinka, 1993) (Ramesh and Vinodh ,2020). **PP** is non-poisonous (Maddah, 2016). In addition, the carbon emission for **PP** polymer corresponds to 1.34 kg CO₂ equivalent (Greene, 2011).

Ethylene/vinyl acetate (EVA) copolymers have no carcinogenic effects(Safety Data Sheet, 2008).They can cause respiratory problems when heated (Safety Data Sheet, 2006).

Polyacrylate polymers lead to some complaints such as burning sensation in their eyes and throat, headaches and fleeting dermatological complaints (Tucek vd., 2002).

PDMS is ecologically inanimate and has been found to have no effect on aerobic or anaerobic bacteria. It does not restrain the biological process by which wastewater is treated (Watts vd., 1993). **Silicones** demonstrate no poisonous to animals and skin stimulation (Chen vd., and Ge, 2011). From an environmental perspective and the present utilization of **silicon dioxide** cause no or little hazard to the environment (Black, 2013).

3.Conclusion and Recommendations

The purpose of this study was to assess the polymers used in the coating of textile materials, their chemical structures, properties, the field of applications and their effects on human health.

A coated fabric is composed of substantially continuous polymeric layers. Man-made substances obtained from natural in addition to synthetic products can be used for coating. In coating of textile materials not only homopolymers but also copolymers and polymer mixtures are used. The classification of polymers according to their chemical structure and their fields of application is given in Table 1. Various thermoplastic polymers (for instance, PVC (polyvinylchloride), polyurethanes(PU), polyacrylate, polyolefins(PE, PP), natural and synthetic rubber polymers and silicones are extensively used for the coating of textile materials.

Table 1. Classification of polymers according to their chemical structure and their fields of application (Parys, 1994).

Product	Field of application
Polyvinyl acetate (PVAC)	Pile anchoring, dimensional stability
Ethylene vinyl acetate (EVA)	Adhesive properties
Polyacrylate	Synthetic leather, rainwear, screening materials (umbrellas), mattress covers (as a foam compound), upholstery, sportswear and sports articles
Polyolefins(PE,PP)	Deformable car mats, holt melt adhesive
Silicones and elastomers	Water-repellent properties, anorak fabrics, technical clothes, rainwear, synthetic leather, baby clothes, umbrellas, sails, conveyor belts, bedding
Natural rubber (NR)	Rainwear, conveyor belts, floorcoverings, carpets, bed sheeting, camera bellows, mattress lining, rubber dam
Styrene-butadiene rubber(SBR)	Coating of floor coverings, upholstery
Polychloroprene rubber (CR)	Protective clothing, protective apron, antistatic stretcher cover roofing tape.
Nitrile rubber (NBR)	Technical clothes, protective apron
Butyl rubber (HR)	Technical materials, chemical resist clothing
Chlorosulphonated polyethylene(CSM)	Aircraft cover, hose cover, boat fabric, protective clothing
Polyurethane (PUR)	Synthetic leather and suede rainwear, sportswear, floor coverings, tents, life jackets, airbags, sleeping bags, shoe industry
Polyvinyl chloride(PVC)	Synthetic leather, rainwear, technical clothes
Polyvinyl fluoride(PVF)	Protective apron

As a consequence, the most extensively used polymers such as PVC(polyvinyl chloride),PUR (polyurethanes), polyacrylates,polyolefins(PE,PP), natural and synthetic rubber and silicones were summarized:

PVC polymers contain many poisonous chemical substances such as BPA, phthalates, led, dioxin and cadmium. The PVC polymers disposable to severe health risks and environmental contamination. Hence, PVC use has reduced significantly(Proshad vd.,2018). On the other hand, the use of

biobased plasticizers into the PVC materials has illustrated many advantages, such as being non-poisonous and having better compatibility with low migration ability.

Polyurethane polymers are widely used in the coating of textile materials owing to their versatility, excellent mechanical and chemical hindrance properties, comfortability, cost-effectiveness, environment-friendly nature, biocompatibility, antimicrobial efficiency and adhesion properties (Wirpsza,1993).

Polyacrylate polymers are the second group of thermoplastic. They have high stability performances at temperatures $>100^{\circ}\text{C}$. Owing to the high UV hindrance and significantly very economical, acrylic polymers are used in modern car seats. That seats are usually back-coated with acrylic polymers to increase abrasion hindrance and to improve fire hindrance. And also, acrylic resin as waterproof coatings are applied on polyester substrates with crushed foam coating for curtains (Zorn,B.,1984).

Polyolefins are chemically inert, extremely flexible, non-poisonous, very light weight and sterile. They are resistant to all kinds of solvents (Drobny,-J.G.,2007).

The preparation of composite **rubber** materials with natural fiber fillers reduces the production of poisonous and provides a new solution to solve the environmental contamination in the process of rubber production(Zhai, Y., Mao, L., Shen, Y. and Yan, X.,2021). **Natural rubber** latex(NRL) has been used to medical gloves to prevent microorganisms.

Owing to the polar group(nitrile group) and unsaturated double bond in the molecular structure, **NBR(nitrile rubber)** polymers have good oil hindrance,-excellent physical and mechanical properties (Chen and Che,2021). They are non-protein allergen and cause the lowest allergic irritation on human skin. For instance, nitrile gloves offer a latex-free advantage, thus reducing potential allergy concerns (Xu and Wu,2020).

Styrene-butadiene rubber polymers are used in waterproof materials, conveyor belts, adhesives owing to their high wear hindrance, good flexing fatigue hindrance, poor oil and ozone hindrance(Sisanth, K.S.,Thomas, M.G.,Abraham, J., Thomas, S.,2017), shoe heels and coatings (Song,K.,2017).

Silicone's combination with organic compounds (for instance, relatively long Si-O and Si-C bond's performance) have special properties. Compared to organic surfactants, silicone-based materials were less sensitive to temperature. In the textile industry, silicone plays an important role in the production of performance fabrics, smart textile fabrics and practical fabrics in clothing production. And also silicone polymers were used for modification the surface of cellulosic fabrics to improve hydrophilicity properties, soft handle and mechanical properties (Amina vd.,2019).

REFERENCES

- Adetunji, C.O., Olugbemi T. Olaniyan, Osikemekha A. A.(2021).** Environmental Impact of Polyurethane Chemistry, Polyurethane Chemistry: Renewable Polyols and Isocyanates. Chapter 14, pp.393-411.
- Al-Eiiji, M., Al-Qahhtani, N. (2021).** Determining the Environmental Effects of Recycled Polypropylene Reinforced with Wood flour and Glass Fibers via a Life Cycle Assessment, Journal of Multidisciplinary Engineering Science Technology, vol. 8, pp.14524-14529.
- Alsabri, A., Al-Ghamdi, S.G. (2020).** Carbon footprint and embodied energy of PVC, PE and PP piping: Perspective on environmental performance, Energy Reports, 6, pp.364-370.
- Alshangiti, D.M. (2021).** Impact of a nanomixture of carbon black and clay on the mechanical properties of a series of irradiated natural rubber/butyl rubber blend, e-Polymers, 21, pp.663-670.
- Amina, L., Hassaba, A.G.(2019).** Review of silicon-based materials for cellulosic fabrics with functional applications, Journal of Textiles Coloration and Polymer Science, vol.16, No.2, pp.139-157.
- Antelava, A., Damilos, S., Hafeez, S., Manos, G., S.M. AL-Salem, S.M., Sharma, B.K., Kohli, K. and Constantinov, A.(2019).** Plastic Solid Waste (PSW) in the Context of Life Cycle Assessment(LCA) and Sustainable Management, Environmental Management, 64(2) , pp.230-244.
- Bergstram J.(2015).** Mechanics of Solid Polymers, pp.464-467.
- Beigbeder, J., Soccalingame, L., Perrin, D., Benezet, J., Bergeret, C. (2019).** How to manage biocomposites wastes end of life ? A life cycle assessment approach (LCA) focused on polypropylene (PP)/wood flour and polylactic acid (PLA)/faux fibres biocomposites, Waste Management, Vol.83, pp.184-193.
- Bora, R.R. , Wang, R., You, F.(2020).** Waste Polypropylene Plastic Recycling toward Climate Change Mitigation and Circular Economy: Energy, Environmental and Technoeconomic Perspectives, ACS Sustainable Chemical Engineering, 8(43), pp.16350-16363.
- Calvin E. S. (1959).** Vinyl and Related Polymers, John Wiley & Sons Inc., New York.
- Canadian Environmental Protection Act (2013).** Screening Assessment for the Challenge, Carbon Black, Chemical Abstracts, 1333-86-4, Ottawa, Canada, pp.1-88.
- Chaiear, N.(2001).** Health and safety in the rubber industry , volume 12, number 6, pp. 22.
- Chen, J., Chen, W., Zhang, D.(2014).** Experimental study on uniaxial and biaxial tensile properties of coated fabric for airship envelopes, Journal of Reinforced Plastics Composites, 33(7), pp.630-647.

- Chen, S., Chen, S., Jiang, S., Mo, Y., Luo, J., Tang, J. and Ge, Z. (2011).** Study of Zwitterionic Sulfopropylbetaine Containing Reactive Siloxanes for Application in Antibacterial Materials, *Colloids and Surfaces, B: Biointerfaces*, 85(2), pp. 323-329.
- Chen, S., Chen, S., Jiang, S., Xiong, M., Luo, J., Tang, J. and Ge, Z. (2011).** Environmentally Friendly Antibacterial Cotton Textiles Finished with Siloxane Sulfopropylbetaine, *ACS Applied Materials & Interfaces*, 3(4), pp. 1154-1162.
- Chu, H., Ma, J.(2018).** A strategy to prepare internally plasticized PVC using a castor oil based derivative, *Korean Journal of Chemical Engineering*, vol.35, pp.2296–2302.
- Clary, J.J.(1988).** Chronic and reproduction toxicologic studies on vinyl acetate, Status reported Annual New York Academic Science, 534, pp.255-260.
- Cornelissen, E. R., Boomgaard,T., and Strathmann, H.(1998).** Physicochemical Aspects of Polymer Selection for Ultrafiltration and Microfiltration Membranes, *Colloids and Surfaces A: Physicochemical and Engineering Aspects*, 138, no. 2-3, pp.283-289.
- Cousins, K.(2002).** *Polymers in Building and Construction*, Rapra Technology LTD: Shawbury, UK.
- Deshmukh, S. P., and Li,K.(1998).** Effect of Ethanol Composition in Water Coagulation Bath on Morphology of PVDF Hollow Fibre Membranes, *Journal of Membrane Science*,150, no. 1, pp.75-85.
- Dogan, O., Dag, R.(2017).** Application of nano coating (SiO₂) on textile products, *Journal of Chemistry and Chemical Engineering*, 11, pp.82-85.
- Drobny,J.G.(2007).** *Handbook of thermoplastic elastomers* ,PDL Handbook Series, Elsevier.
- Edlich, R.F., Suber,F., Neal, J.G., Jackson,E.M. and Williams, F.M. (2022).** Integrity of powder-free examination gloves to bacteriophage penetration, *Journal of Biomedical Materials Research*, 48(5),pp.755–758.
- El-Aaser, M.S. and Vanderhoff, J.W.(1981).** Emulsion Polymerization of Vinyl Acetate, *Journal of Applied Science Publishers*.,London, Englewood, NJ.
- EPA,(1997).** Integrated Risk Information System(IRIS). Reference concentration for inhalation exposure for vinyl acetate, *Health and Environmental Assessment*.
- EREZ Tech. Text (2020).** Hypalon vs, TPU coating for RIBs - what builds a better boat,. <https://erez-therm.com/hypalon-vs-tpu-coating-for-ribs>.
- EREZ Tech. Text. (2019).** Fuel Bladder Material: TPU vs Hypalon,. <https://erez-therm.com/fuel-bladder-material-tpu-hypalon>.
- Euna Lee, Jongjun Kim. (2014).** A study on practical function of neoprene fabric design in wearable device for golf posture training: focus on assistance band with arduino/flex sensor, *Journal of Fashion Business*, vol.18, issue 4, pp.1-14.

- Faridul Hasan, K.M., Horváth, P.G., Baş, S. and Alpár, T. (2021).** Materials and Chemistry of Flame-Retardant Polyurethanes, Volume 1: A Fundamental Approach, Chapter 11: Industrial Flame Retardants for Polyurethanes, pp. 239-264 .
- Feiring, A.E. (1994).** Fluoroplastics, *Organofluorine Chemistry*: Springer, pp.339–372.
- Flint, S. D., and Slade, R.C.T. (1997).** Investigation of Radiation-Grafted PVDF-g-polystyrene-sulfonic-acid Ion Exchange Membranes for use in Hydrogen Oxygen Fuel Cells, *Solid State Ionics* 97, no. 1-4 , pp.299-307.
- Fung, W. (2002).** Coated and Laminated Textiles, The Textile Institute, Woodhead Publishing Ltd., Cambridge: UK.
- Fusco, J. V., and Hous, P. (1987).** Rubber Technology. NY: Van Nostrand Reinhold Co., edited by M. Morton.
- Galve, J.E., Elduque, D., Pina, C., Javierre, C. (2021).** Life Cycle Assessment of a Plastic Part Injected with Recycled Polypropylene: A Comparison with Alternative Virgin Materials, *International Journal of Precision Engineering and Manufacturing-Green Technology*.
- Gebreab, K.Y., Eeza, M.N.H., Bai, T., Zuberi, Z., Matysik, J., Shea, K.E.O., Alia, A., Berry, P. (2020).** Comparative toxicometabolomics of perfluorooctanoic acid (PFOA) and next-generation perfluoroalkyl substances, *Environmental Pollution*, vol.265, Part A, 114928.
- Geng, X., Gao, Y., Wang, N., Han, N., Zhang, X., Li, W. (2021).** Intelligent Adjustment of Light-to-Thermal Energy Conversion Efficiency of Thermo-Regulated Fabric Containing Reversible Thermochromic MicroPCMs, *Chemical Engineering Journal* , vol.408, 127276.
- Gersak, J. (2013).** Design of Clothing Manufacturing Processes, A systematic approach to planning, Woodhead Publishing, pp.145-208.
- Greene, J. (2011).** Life Cycle Assessment of Reusable and Single use Plastic Bags in California. Chicago.
- Guignier, C., Camillieri, B., Schmid, M., Rossi, R.M., Bueno, M, A. (2019).** E-knitted textile with polymer optical fibers for friction and pressure monitoring in socks, *Sensors*, 19(13), 3011, pp.1-19.
- Ingarao, G., Licata, S., Sciortino, M., Planeta, D., Lorenzo, R.D., Fratini, L. (2017).** Life cycle energy and CO₂ emission analysis of food packaging: An insight into the methodology from an Italian perspective, *International Journal of Sustainable Engineering*, vol.10, No.1, pp.31-43.
- International Textile Magazine (2001).** Textile Month, <http://www.textile-month.com>, June.
- Jackson, E.M., Williams, F.M., Neal, J.G., Suber, F., Thacker, J.G. and Edlich, R.F. (2002).** Biomechanical performance of examination gloves, *Journal of Biomedical Materials Research*, 48(4):572–577.

- Jacob, M. M. E., Prabakaran, S.R.S. and Radhakrishna,S.(1997).** Effect of PEO Addition on the Electrolytic and Thermal Properties of PVDF-LiClO₄ Polymer Electrolytes, *Solid State Ionics* 104, No. 3, pp.267-276.
- Janajreh, I., Alshrah,M., Zamzam,S.(2015).** Mechanical recycling of PVC plastic waste streams from cable industry: A case study, *Sustainable Cities and Society*, vol. 18, pp. 13–20.
- Jia, P., Xia, H., Tang, K., Zhou, Y.(2018).** Plasticizers derived from biomass resources: A short review, *Polymers*, 10, 1303,pp.1-27.
- Jianprasert, A., Monvisade, P., Yamaguchi, M.(2015).** Combination of tung oil and natural rubber latex in PVA as water based coatings for paperboard application, *MATEC Web of Conferences*, 30, 03010, pp.1-4.
- Johnson,W.J.(2018a).** Safety Assessment of Fluoropolymers as Used in Cosmetics.
- Johnston, C.J., Finkelstein, J.N., Mercer, P., Corson, N., Gelein, R., Oberdörster, G.(2000).** Pulmonary effects induced by ultrafine PTFE particles, *Toxicology and Applied Pharmacology*, 168(3), pp.208– 215.
- Kaboorani,A.,Riedl,B.(2015).**Mechanical performance of polyvinyl acetate (PVA)-based biocomposites, *Biocomposites*, pp.347-364.
- Kanny, K., Mohan,T.P.(2017).** Progress in Rubber Nanocomposites,pp.153-177.
- Kim, K.W., Kim, J.C., Moon, J.H., Koo, H., Kim, T.H., Moon, N.J.(2013).** Management of complicated multirecurrent pterygia using multimicroporous expanded polytetrafluoroethylene, *Clinical Science*, 97, pp.694-700.
- Kos, I., Schwarz, I.G.,Suton, K.(2014).** Influence of warp density on physical-mechanical properties of coated fabric, *Procedia Engineering*,vol. 69, pp.881–889.
- Kruger, S. (2009).** Textile Architecture, Textile Architektur, Jovis Yayım, Münih.
- Krzysztof, L. and Katarzyna, S. (2022).** A Brief Review of Poly(Vinyl Chloride) (PVC) Recycling, *Polymers*, 14,3035, pp.1-14.
- Kumar, V., Kothiyal, N.C., Vikas, P.,Sharma, R. (2016).** Sources, distribution and health effect of carcinogenic polycyclic aromatic hydrocarbons (PAHs) –current knowledge and future directions, *Journal of the Chinese Advanced Materials Society*, vol.4,Issue 4, pp.302–321.
- Lee, S., Park, M. S., Shin, J., Kim, Y. W.(2018).** Effect of the individual and combined use of cardanol-based plasticizers and epoxidized soybean oil on the properties of PVC, *Polymer Degradation Stability*,vol.147, pp.1-11.
- Lenoble,B., Stassen, S., Stevens, C. and Thomas, X.(2013).** Silicones in Industrial Applications in *Inorganic Polymers, An Advanced Research Book* by Nova Science Publishers, edited by Roger De Jaeger.
- Lin X., Benzhang Z., Chao W., Fubao Z.(2020).** Current status and prospects of high-performance synthetic rubber in china, *Strategic Study of Chinese Academy of Engineering*, vol 22, issue 5, pp.1-10.

- Liu, X., Lou, Y. (2015).** Preparation of Microencapsulated Phase Change Materials by the Sol-Gel Process and Its Application on Textiles, Fibres & Textiles in Eastern Europe, 23(2),110, pp. 63–67.
- Liu, M., Han, S., Shang, W., Qi, X., Dong, S. (2019).** New polyurethane modified coating for maintenance of asphalt pavement potholes in winter-rainy condition, Progress in Organic Coatings, 133(5), pp. 368-375.
- Lohmann, R., Cousins, I.T., De Witt, J.C., Glüde, J., Goldenman, G., Lindstram, A.B., Miller, M.F., Scheringer, M., Wang, E. (2020).** Are Fluoropolymers Really of Low Concern for Human and Environmental Health and Separate from Other PFAS, Environmental Science & Technology, 54, pp.12820-12828.
- Luciani, V., Bonifazi, G., Rem, P. and Serranti, S. (2015).** Upgrading of PVC rich wastes by magnetic density separation and hyperspectral imaging quality control, Waste Management, vol. 45, pp. 118– 125.
- Maddah, H.A. (2016).** A review Polypropylene as a Promising Plastic: A Review, American Journal of Polymer Science, 6(1), pp.1-11.
- Mandlekar, N., Joshi, M., Butola, B. (2022).** A review on specialty elastomers based potential inflatable structures and applications, Advanced Industrial and Engineering Polymer Research, 5, pp.33-45.
- Mazon, G., Zahid, M., Heredia-Guerrero, J.A., Balliani, E., Zendri, E., Athanassiou, A., Bayer, I.S. (2019).** Hydrophobic treatment of woven cotton fabrics with polyurethane modified aminosilicone emulsions, Applied Surface Science, vol. 490, pp.331-342.
- Meeker, J.D., Sathyanarayana, S. & Swan, S.H. (2009).** Phthalates and other additives in plastics: human exposure and associated health outcomes, Philosophical Transactions of The Royal Society, Biological Sciences, 364, pp.2097-2113.
- Mertgenç, C., Enginar, H., Yılmaz, H. (2021).** Microencapsulation of Fragrance with Polyurethane-Urea and Application on Different Fabrics, Iranian Journal of Science and Technology Transaction. A, Material Science, 45, pp.1677–1687.
- Mukherjee, S., Ghosh, M. (2017).** Studies on performance evaluation of a green plasticizer made by enzymatic esterification of furfuryl alcohol and castor oil fatty acid, Carbohydrate Polymers, vol 157, pp.1076-1084.
- Neissl, W., Ledwinka, H. (1993).** Polypropylene-The Future has only just begun, Kunststoffe, Ger Plast.
- New Jersey Department of Health and Senior Services (1998).** Hazardous Substance Fact Sheet.
- Omrani, I., Ahmadi, A., Farhadian, A., Shendi, H. K., Babanejad, N., Nabid, M. R. (2016).** Synthesis of a bio-based plasticizer from oleic acid and its evaluation in PVC formulations, Polymer Testing, vol.56, pp. 237-244.

- Ostrovskii, D. I., Torell, L.M., Paronen, M., Hietala, S. and Sundholm, F. (1997).** Water Sorption Properties of and The State of Water in PVDF-based Proton Conducting Membranes, *Solid State Ionics*, 97, no. 315, pp.315-321.
- Padhiyar B., Wagh S. (2022).** Successful Experiments in Blending Rubber(s) with Polyester Waste Fabric to Produce Products of Industrial and domestic use, *Research Square*, pp.1-15.
- Panrat, K., Boonme, P., Taweepreda, W., Pichayakorn, W. (2012).** Formulations of natural rubber latex as film former for pharmaceutical coating, *Procedia Chemistry*, 4, pp.322–327.
- Parys, M. (1994).** Coating, Eurotex, Guimaraes, Belgium., pp.25-49.
- Patocka J, Bajgar J. (2009).** Toxicology of perfloroisobutene, *ASA Newsletter*, www.asa.nltr.com
- Pereira, S., Anand, S.C., Rajendran, S., Wood, C. (2007).** A study of the structure and properties of novel fabrics for knee braces, *Journal of Industrial Textiles*, 36(4), pp. 279-300.
- Pilch-Pitera, B., Czachor, D., Kowalczyk, K., Paulova, E., Woturski, J. (2019).** Conductive Polyurethane-Based Powder Clear Coatings Modified with Carbon Nanotubes, *Progress in Organic Coatings*, vol. 137, 105367.
- Pionteck, J. and Wypych, G. (2017).** Handbook of Antistatics, Second Edition, pp.287-357.
- Potocic-Matkovic, Skenderi, Z. (2013).** Mechanical properties of polyurethane coated knitted fabrics, *Fibres & Textiles in Eastern Europe*, 21, 4(100), pp. 86–91.
- Proshad, R., Kormoker, T., Islam, S., Haque, M., Rahman, M., Mithu, M.R. (2018).** Toxic effects of plastic on human health and environment, *International Journal of Health*, 6(1), pp.1-5.
- Radulovic, L.L., Wojcinski, Z.W. (2014).** PTFE (Polytetrafluoroethylene Teflon®). In: Wexler P, ed. *Encyclopedia of Toxicology*, 3rd ed. Amsterdam, Netherlands, Elsevier, pp.1133-1136.
- Ramesh, P., Vinodh, S. (2020).** State of art review on Life Cycle Assessment of polymers, *International Journal of Sustainable Engineering*, 13(6), pp.411-422.
- Rego, A., and Roley, L. (1999).** In-use barrier integrity of gloves: Latex and nitrile superior to vinyl. *American Journal of Infection Control*, vol. 27(5), pp.405–410.
- Rengarajan, T., Rajendran, P., Nandakumar, N., Lokeshkumar, B., Rajendran, P., Nishigaki, I. (2015).** Exposure to polycyclic aromatic hydrocarbons with special focus on cancer, *Asian Pacific Journal of Tropical Biomedicine*, vol. 5, issue 3, pp.182–189.
- Romaskevicius, T., Budriene, S., Pieličowsky, K., Pieličowsky, J. (2006).** Application of polyurethane-based materials for immobilization of enzymes and

cells: A review, *Chemija*, 17(4), pp.74-89.

Safety Data Sheet. No.1907/2006, No.1272/2008, pp.1-8.

Schielen, P., Rodijnen, W., Tekstra, J., Albers, R. and Seinen, W. (1995). Quantification of Natural Antibody Producing B Cells in Rats by an Improved ELISPOT Technique using the Polyvinylidene Difluoride Membrane as the Solid Support, *Journal of Immunological Methods*, 188, no.1, pp.33-41.

Schneider, C., Langer, R., Voveday, D., Hair, D. (2017). *Journal of Controlled Release*, 262.

Seymour, R. and Charles, E., 1981. *Polymer Chemistry*, Marcel Dekker, Inc., New York.

Shah, A., Hasan, F., Shah, Z., Mutiullah, H.A. (2012). Degradation of polyisoprene rubber by newly isolated *Bacillus* sp. AF-666 from soil, *Applied Biochemistry and Microbiology*, 48, pp.37-42.

Shaw, J.D.N. (2001). *Industrial Flooring, Plant Engineer's Handbook*, pp.101-109.

Silva, M. A., Vieira, M. G. A., Macumoto, A. C. G., Beppu, M. M. (2011). Polyvinylchloride (PVC) and natural rubber films plasticized with a natural polymeric plasticizer obtained through polyesterification of rice fatty acid, *Polymer Testing*, 30, 478.

Sisanth, K.S., Thomas, M.G., Abraham, J., Thomas, S. (2017). General introduction to rubber compounding, *Progress in Rubber Nanocomposites*, pp.1-39.

Smart, M. F. Kalt and Takei, N. (1993). *Silicones, Chemical Economics Handbook*, Stanford Research Institute International, Menlo Park, California.

Song, K. (2017). Micro and nano-fillers used in the rubber industry, *Progress in Rubber Nanocomposites*, pp.41-80.

Srivastava, H.P., Arthanareeswaran, G., Narayanan A., Starov V. (2011). Performance of modified poly(vinylidene fluoride) membrane for textile wastewater ultrafiltration, *Desalination*, vol. 282, pp.87-94.

Stankovic, E., Švarc, U., Šumiga, B., Urbas, R. (2017). Melamine Formaldehyde Microcapsules with Fragrance Core Material: Preparation, Properties, and End Use, *Textile Research Journal*, 87, pp.2435-2448.

Sultan, M., Masood, R., Bibi, I., Sajid, I., Islam, A., Atta, S., Uroos, M., Safa, Y., Bhatti, H.N. (2019). Impact of soft segment size on physicochemical and antimicrobial properties of waterborne polyurethane dispersions for textile applications, *Progress in Organic Coatings*, vol.133, pp.174-179.

Suzuki, A. H., Botelho, B. G., Oliveira, L. S., Franca, A. S. (2018). Sustainable synthesis of epoxidized waste cooking oil and its application as a plasticizer for polyvinyl chloride films, *European Polymer Journal*, 99, pp.142-149.

Tarlton, J. F., and Knight, P.J. (1996). Clarification of Immunoblots on Polyvinylidene Difluoride (PVDF) Membranes for Transmission Densitometry, *Journal of Immunological Methods*, 191, no. 65, pp. 65-69.

- Troughton, M.J.(2008).** Adhesive Bonding, Handbook of Plastics Joining(Second Edition).
- Tsuruta,T. and Driscoll,K.F. (1969).** Structure and Mechanism in Vinyl Polymerizations, M.Dekker Inc., New York.
- Tucek, M., Tenglerova, J., Kollarova, B., Kvasnickova, M., Maxa,K., Mohyluk,I., Svandova, E., Topalcan, O., Vlasak, Z., Cilert, M.(2002).** Effect of arcylyate chemistry on human health, International Archives of Occupational Environmental Health,75,pp.67-72.
- Tuladhar, R., Yin, S. (2019).** Sustainability of using recycled plastic fiber in concrete, Use Recycled Plastics Eco-efficient Concrete,pp. 441-460.
- United States National Institute for Occupational Safety and Health,.(1978).**
- Van Baarle, B. (2003).** Natural Rubber for Fashion, Nutuurrubber 32(4th Quarter), pp.7-8.
- Van Benthem., R.A. (2000).** Novel hyperbranched resins for coating applications, Progress in Organic Coatings, 40(1), pp. 203–214.
- Venkatesan, A.K., Halden, R.U. (2014).** Wastewater treatment plants as chemical observatories to forecast ecological and human health risks of man-made chemicals, Scientific Reports, 4,3731,pp.1-7.
- Vinyl Acetate Summary Risk Assessment Report, (2008).** Bundesanstalt für Arbeitsschutz und Arbeitsmedizin (BAuA) Anmeldestelle Chemikalien / Zulassungsstelle Biozide (Federal Institute for Occupational Safety and Health Division for Chemicals and Biocides Regulation) Friedrich-Henkel-Weg, 1-25.
- Wang, H., Easteal, A., Edmonds, N.(2008).** Prevulcanized natural rubber latex/modified lignin dispersion for water vapour barrier coatings on paperboard packaging, Advanced Material Research, 47, pp. 93-96.
- Watts, R.J., Udell, M.D., Monsen, R.M.(1993).** Use of iron minerals in optimizing the peroxide treatment of contaminated soils, Water Environmental Research, 65 ,pp. 839- 844.
- Wirpsza,Z.(1993).** Polyurethanes: Chemistry, Technology, and Applications, Ellis Horwood Limited, Chichester.
- Wootton, D.B. (2001).** The Application of Textiles in Rubber,RAPRA Technology Ltd., Shawbury: UK.
- World Health Organization. Perfluoroisobutane.(2004).** Chemical Agents, Annex 1, In: Public health response to biological and chemical weapons, Geneva, WHO guidance.
- Xianho, Lu., Zhou,J., Zhao,Y., Yong Qiu and Jinghang Li., (2008).** Room Temperature Ionic Liquid Based Polystyrene Nanofibers with Superhydrophobicity and Conductivity Produced by Electrospinning, Chemistry of Materials, 20, pp. 3420-3424.

- Xiaoming, Q., Wentong, Y., Laiming, Y., Wenjun, W., Hanhao, L., Yanglong, W., Shanwen, Z., Yaofeng, Z., Xianddong, L., Yubing, D., Yaqin, F. (2019).** Design of ethylene-vinyl acetate copolymers fiber with two-way shape memory effect, *Polymers*, 11, 1599, pp.1-15.
- Xie, C. (2017).** Study on Low Temperature Resistance of Modified PVC Coating Fabrics, Zhejiang: Zhejiang Sci-Tech University.
- Xinrong,S., Nanfang,W., Kunyang,S., Sha,D. and Zhen,C. (2014).** Synthesis and characterization of waterborne polyurethane containing UV absorption group for finishing of cotton fabrics, *Journal of Industrial and Engineering Chemistry*, 20(5), pp. 3228–3233.
- Xu, X.J., Wu, X., and Wang, H.S. (2020).** Selection and Use of Laboratory Chemical Protective Gloves, *Labour Protection*, 68 (08),pp.84–85.
- Sun,Y., Chen,H., Yin,H., Sun,B., Gu,B.and Zhang,W.(2020).**Smart Materials and Structures, Volume 29, Number 8.
- Yin,S., Tuladhar,R., Sheehan,M., Combe,M., Collister,T.(2016).** A life cycle assessment of recycled polypropylene fibre in concrete footpaths, *Journal of Cleaner Production*, vol.112, part 4, pp. 2231-2242.
- Yinghao,M.D., Zhang,Z.Y. (2021).** A green approach to preparing hydrophobic, electrically conductive textiles based on waterborne polyurethane for electromagnetic interference shielding with low reflectivity, *Chemical Engineering Journal*, Part 2, pp.127-749.
- Yong K., Kim.(2017).** The use of polyolefins in industrial and medical applications, *Polyolefin Fibres(Second Edition)*, pp.288-289.
- Zhai, G., Kang,E.T. and Neoh, K.G.(2003).** Poly(2-vinylpyridine)-and Poly(4-vinylpyridine)-graft-poly (vinylidene fluoride) Copolymers and their pH-Sensitive Microfiltration Membranes, *Journal of Membrane Science*, 217, no. 1-2 ,pp. 243- 259.
- Zhai, Y., Mao, L., Shen,Y. and Yan, X.(2021).** Research Progress of Cut-Resistant Textile Materials, *Frontiers in Chemistry*, vol.9, pp.12.
- Zhang, S., Xu, J., Sun, Y. (2021).** Construction of porous polymer films on rGO coated fabric for self-powered pressure sensors in human motion monitoring, *Cellulose*, 28(7), pp. 4439-4453.
- Zhanyum, W., Cousins, I.T., Scheringer, M., Hungerbuchler,K.(2015).** Hazard assessment of fluorinated alternatives to long-chain perfluoroalkyl acids(P-FAAs) and their precursors: status qua, on going Challenges and possible solutions, *Environment International*, 75, pp.172-179.
- Zorn, B.,(1984).** *Journal of Coated Fabrics*, 3, 166.

“

Chapter 3

THE ROLE OF BUILDING CONTROL FIRMS IN REDUCTION OF OCCUPATIONAL ACCIDENTS IN THE CONSTRUCTION SECTOR

Glden ASAN¹, Deniz ERDAL²

”

1 Hitit University, Vocational School of Technical Sciences, guldenasan@hitit.edu.tr , Çorum, Türkiye ORCID: 0000-0002-6075-159X

2 Hitit University, Graduate School of Education, Department of Occupational Health and Safety, denizerdal89@gmail.com , Çorum, Türkiye ORCID: 0000-0001-8826-0234

1. INTRODUCTION

In today's working world, people continue their working life around too many possible dangers that will put their safety and health at risk. For example, the construction worker working at height works under the risk of falling, the impact of dust that will affect the health of the miner and explosion, the slaughterhouse worker or the cook working in the kitchen environment by cutting his hand with a knife or other cutting tools, the workers in various sectors working in rural areas are at risk of poisoning from harmful insects. faces many different dangers. There are many and different health and safety risks in all business life, as the level of importance differs according to the importance of the work done. Occupational disease and work accident that occurs do not only concern the life of the worker, but also cause undesirable consequences for his family and society that are difficult to compensate for in terms of social and financial aspects. While this is the case, before going for the compensation of the loss caused by the work accident and occupational disease; It is of great importance to take measures to prevent the occurrence of occupational diseases and work accidents, and in the light of this, OHS rules are determined within the legal framework, adopted and accepted by both employees and employers and applied in business life. Although it is considered as a goal to be completely protected from all the dangers mentioned, it does not seem possible to reach such a conclusion as a result. OHS, which aims to contribute positively to the work they can do, their work enthusiasm and productive work by providing a healthier and safer working environment to the employees, has almost become the indicator of the development level of the nations. With the creation of OHS awareness in workplaces, it is possible to reduce the financial damage caused by work accidents and occupational diseases as much as possible. In addition, the moral damages caused by occupational accidents and occupational diseases for the society reveal the fact that OHS is not only materially, but also an ethical human thought. (Tozkoparan & Taşoğlu, 2011). The construction business line has a positive impact on the social life with the positive impact it adds to the economy of the country with the products and services it produces with its sub-sectors of more than three hundred directly related to it, and the employment capacity it creates. On the other hand, it affects business life negatively, as work accidents, which cause hard-to-return results, are much higher than in other sectors. In this study, the concept of building inspection in the construction business will be discussed in general; In principle, the responsibilities of building inspection companies related to OHS in the construction sector have been discussed in line with the Law No. Checklist forms have been proposed for the different manufacturing stages of the construction so that they can fulfill these responsibilities effectively. Later,

the Elmeri observation form used in the industry was adapted to the construction sector and the ELMERI^{construction} Observation Form was prepared to calculate the Elmeri safety index.

2. OCCUPATIONAL HEALTH AND SAFETY

World Health Organization and International Labor Organization occupational health; To ensure that the employees reach and maintain the highest level of mental, physical and social in all aspects in all work areas, to prevent the employees from losing their health due to work accidents and working conditions, to regulate the working conditions and make them compatible with universal rights, to work, briefly defined as allocating the harmony between work and people. World Health Organization and International Labor Organization occupational health; To ensure that the employees reach and maintain the highest level of mental, physical and social in all aspects in all work areas, to prevent the employees from losing their health due to work accidents and working conditions, to regulate the working conditions and make them compatible with universal rights, to work, briefly defined as allocating the harmony between work and people. Occupational health and safety; It can be expressed as all the work done to protect the employees from the dangers that may occur during the production phase and to ensure that the employees do business in a working environment with basic human rights. The International Labor Organization has not evaluated the latest current concept of health as merely not being sick or disabled, but has taken it into consideration as the hygiene, conditions and safety of the working environment and has made it as covering all factors affecting the employee. The World Health Organization defines health; not only that the employee is not disabled or sick, but also that the employee is fully well, happy and productive in all aspects (WHO, 2001). In another definition; All the studies carried out in order to ensure that the employees are protected from all kinds of accidents or situations that may affect their health in the working environment. (The Ministry of Labor and Social Security, 1995). To explain the studies related to OHS in general: To protect all employees against the dangers that may occur in the working environment by taking all possible safety precautions, to eliminate the elements that threaten their health and safety negatively, with appropriate methods, and to the health problems and occupational diseases that occur in the workers, is to mobilize the maximum resources necessary for treatment. In addition, with the measures to be taken, it is to prevent possible accidents as much as possible by creating a high level of welfare in the enterprise and to maximize production continuity and efficiency in the workplace. The aim is not only to ensure the health of the employees with the precautions and measures to be taken, but also to create the conditions where they can work in a comfortable and peaceful environment and

to ensure that they are happy and motivated. Employees who see that they are valued will increase their commitment to their workplaces and accordingly, the care and effort they show will increase, and this will positively affect their trust in the employer and their managers. As a result of all of them, productivity and continuity will increase in production.

3. BUILDING CONTROL

The first examples of building control can be found in the laws of Hammurabi prepared by the Babylonian Emperor Hammurabi in the 18th century BC. The aforementioned law was created as a mixture of the constitution and civil law, and it was assumed to be the first written law in the history of the world, although it is a series of certain rules and orders (Doğan, 2013). Although there is no written document after the ancient age, as in all periods in history, importance has always been given to the robust and high quality of the structures in which the society continues its life, and some sanctions have been applied regarding this issue. It is known that this issue was given importance in the legal innovation studies of the Roman Period, which is one of the most important points of modern social law. Roman laws implemented the settling within the concept of loss-damage-victimization, with lighter sanctions compared to the previous period, but by specifying the procedure in detail. For example; During the dismantling of an arch whose construction was completed during the Roman Empire Period, the engineer responsible for making the arch is required to stand under the arch. During the time of the Roman Empire, which is assumed to be one of the golden periods of the art of construction and engineering in history, not only the buildings where people would stay, but also the buildings that could be used as a society were built to a great extent. Although some of the aforementioned structures are now in ruins, it is possible to encounter structures (Collesio, Pantheon Church, etc.) that arouse great admiration even today in some parts of Italy in Rome. Since the Roman Empire had very large lands at that time, a certain part of the aforementioned structures are located in Anatolian lands. All these mentioned structures are one of the biggest indicators of the extent to which the engineering and building principles developed in those times. In addition to the absence of written documents that have survived to the present day, it is inevitable that a quality surveillance and control mechanism should exist in the Roman construction sector. Because it is clearly seen that great importance was given to the construction of Gothic cathedrals. Due to the lack of construction knowledge at that time, almost all of the buildings in this era are in the structurally extremely robust class, since the buildings were generally built with thicker building elements than they should have been, and with a smaller span than they should have been. In addition to the aforementioned extremely robust approach, there is still a question mark

whether there is a building inspection system (Karaesmen, 1989). No written documents related to the control of the building were encountered in the Ottoman history. However, it is clear that the safety and quality class of the building is one of the most important and applied issues for the period in question. Because it is obvious when seen directly that the structures built by Mimar Sinan are highly reliable in terms of manufacturing quality. For example, “Mimar Sinan; Let’s think about the Great Drawer Bridge, one of his highly praised works. This bridge, which was constantly damaged by floods, started to work with the decision of the safety criterion of the building, which he kept at the forefront during the construction phase, and arranged his work accordingly, making it a bridge that will never be destroyed again. Big Sinan; Comparing the solidity of the structure in the Süleymaniye Mosque, which he built as a monument, to Hagia Sophia; ‘Under the pillarless cupola, the dome never existed like the elhak Hagia Sophia, from the moment it became an enormous building. He explained that Hüda’s grace is a guide, and that he has created a more magnificent structure in terms of structure”. In the same period, the widening of the sections by keeping the spans and heights at a certain limit is a proof that the necessary care was shown to the durability of the structure. Architect Sinan also took it upon himself to establish an organization in order to produce durable and many works. In this way, it enabled many large works to be built at the same time, and the development work, which is important throughout the country, was implemented (Açikel, 1998).

Building Control, in order to establish the criteria of functionality, reliability and being economical, considering the type of all buildings and their own characteristics, in accordance with the project and relevant laws, regulations, standards and instructions for each stage of the construction within the system, as well as economic and environmental criteria, time period. It is all of the technical and administrative applications, examinations and studies, including tests and experiments to prevent loss of comfort, aesthetics and comfort. In other words, it is the activity of controlling the construction in plan and construction for the construction of a healthy and safe structure that adheres to the zoning law, science, art and health criteria and legislation in order to secure people’s life and property. (Kural, 2015).

Building inspection companies are obliged to fulfill the following duties and responsibilities as the main objective:

- To control the projects that will be used in the ground survey report and the implementation phase of the parcel or land where the construction will be made, in terms of the relevant standards and regulations, by examining the application project accounts and reports prepared by the project author and given directly to the organization, and any administration other

than the relevant administrations. and to express the opinion that it is appropriate to the relevant administration, without the need for permission and approval of the management,

- To make a commitment by giving a commitment to the relevant administration regarding the structure for which the building inspection is undertaken,

- By signing the part of the construction permit related to the establishment, and notifying the relevant Ministry within 7 days after the issuance of the construction permit, of the information and documents to be given regarding this construction,

- To supervise the construction of the construction by adhering to certain standards, laws and regulations related to plans, projects, reports and licenses,

- To ensure that all the materials to be used in the construction phase are in compliance with the plan, project and legislation used in the production phase and to document the control result, to have the tests and experiments of the materials used during the production carried out by the relevant institutions,

- To deliver a copy of the documents issued in relation to all the inspection activities carried out, to the relevant administrative unit, to inform the relevant administration in the form of a report or a report, in case of detection of a situation that contradicts the legislation related to the materials used in construction or manufacturing during the inspection process,

- To warn the contractor with a report in order to implement the necessary measures regarding occupational health and safety in the enterprise, and to report the incident to the provincial directorate of the relevant labor and employment institution in case the aforementioned warning is not taken into account,

- In case of production inconsistent with the license, project and reports, notifying the relevant unit of the relevant administration within 3 days of the violation,

- Informing the relevant administration and management that part or all of the building has been completed in accordance with the projects in the annex of the license,

- To have the tests and experiments related to the ground on which the production will be made, the material to be used and the manufacturing, in accordance with the legislation criteria, in the laboratories,

Many of the above-mentioned duties have been imposed on the building inspection companies and it has been determined that the owner and

the contractor will be held liable separately at the rate of their defect due to the damage to the building. Through the aforementioned regulation, which was put forward for public trust and public benefit, technical support assignments were given to audit firms in order to meet the common needs of a regional nature.

In the 1999 Marmara and Düzce earthquakes in Turkey, thousands of after the death and injury of a person and the unusable state of many buildings, the competent authorities adopted the necessity of taking concrete steps regarding building inspection. Therefore, by publishing the “Decree Law on Building Inspection” numbered 595 in the Official Gazette dated April 10, 2000 and numbered 24016,

- Increasing the safety of buildings in order to reduce the negative effects that may occur as a result of earthquakes and other natural disasters,
- Reducing the material and moral damages suffered by the owners who have the buildings built or bought, due to defective and defective buildings,
 - To prevent illegal and illegal structures,
 - Improving the quality of the buildings, increasing the economic life of the buildings, reducing the repair and modification costs,
 - To ensure that the profession of engineers and architecture gain prestige,
 - It is aimed to effectively implement sanctions against people who have faults during the construction phase and to increase the trust and belief in the state’s justice and legal system (Kural, 2015).

Afterwards, Law No. 4708 on Building Inspection, prepared by the Ministry of Public Works and Settlement, was published in the Official Gazette on 13.07.2001, to enter into force as of 13.08.2001. The Building Inspection Implementation Procedures and Principles Regulation, which was issued based on the Law on Building Inspection No. 4708, entered into force on 13.08.2001 and was implemented in 19 pilot provinces (Adana, Ankara, Antalya, Aydın, Balıkesir, Bolu, Bursa, Çanakkale, Denizli, Düzce, Eskişehir, Gaziantep, Hatay, Istanbul, Izmir, Kocaeli, Sakarya, Tekirdag and Yalova) have started to be implemented. As of January 2011, it continued to be implemented by spreading to all provinces.

Considering the map of earthquake zones in Turkey, it is seen that 92 percent of Turkey’s lands, 95 percent of its population, as well as 98 percent of large industrial establishments and 92 percent of dams are located in regions where they are at risk due to different earthquake hazards (Map 1). In terms of this geological location in which our country is located, it is obvious

that many earthquakes with heavy damage have been experienced in the past and will continue to do so. From this point of view, between 1900 and 1999, there were 149 major earthquakes that caused loss of life and property, 97,203 people lost their lives and 578,544 buildings were destroyed or severely damaged. 644 people lost their lives in the large-scale earthquakes in Van and Erciş in 2011 (Bilik, 2015). After all these earthquakes, he showed the fact that “people are not killed by earthquakes, but by rotten and uncontrolled structures”. For this reason, it is of great importance that all kinds of investments to be made within the borders of the country are carefully planned and made in accordance with the technical rules.

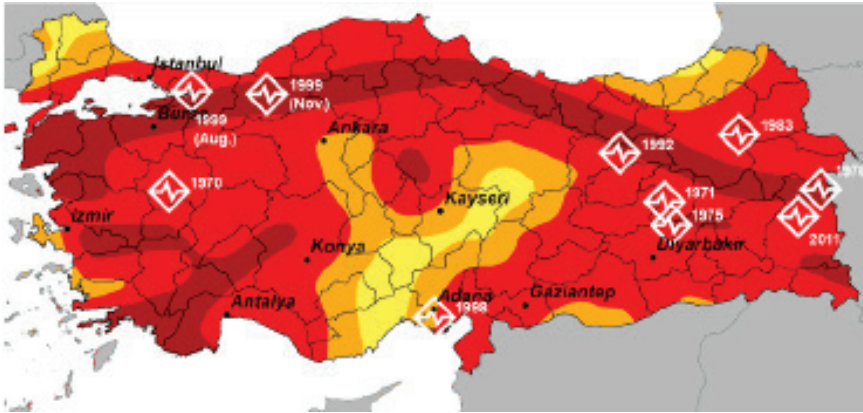

Map 1. Earthquake zones map in Turkey (AFAD, 2011).

The buildings built in Turkey should be inspected in order to be safe, to provide the expected comfort conditions for the people who use it throughout their life, to provide a healthy environment and to prevent damage to the surroundings. Considering that a building is created with very complex systems in today's conditions, it is also seen that the owner or user cannot control such matters as they should, so the building inspection work must be carried out by professional people.

As the general justification of the “Draft Law on Building Inspection”, which was decided by the Council of Ministers on 20.6.2001;

- In Turkey, which is located in one of the most active earthquake zones in the world, 96% of its lands are at various degrees of earthquake risk and 98% of the population lives in the aforementioned earthquake zones, it is in compliance with the zoning and natural disasters legislation that has been in effect for years. It is a clear fact that an effective building inspection cannot be carried out in the implementation phase despite some provisions

- Although the negative consequences of this situation were clearly seen after the earthquake disasters in the last 20 years in Turkey, no pos-

itive attempt was made on building inspection, on the contrary, rapidly increasing population and migration, urbanization and industrialization without inspection, excessive illegal construction and very frequent reconstruction. The amnesties increase the earthquake and other disaster risks in our country day by day,

- Revealing the negative effects caused by the loss of life and property, uncontrolled constructions and settlements after the earthquake disaster that occurred on 17 August and 12 November 1999, with all its nakedness,

- Non-compliance by the relevant administrations with the construction and settlements in Turkey, the Zoning Law No. 3194 and the principles of the regulation related to this law, and the researches show that design, drawing and calculation errors were found in more than 90% of the projects even during the project inspection phase. existence, almost no inspection of the construction phase, production of concrete casting in violation of the relevant legislation in approximately 90% of the constructions, determining that the concrete strength values are approximately 40% less than the specified in the project,

- Recent earthquakes and research. In the Law No. 3194, the technical responsible person (TUS) who took part in the construction phase; municipalities and governorships responsible for supervising construction projects and implementations; the application clearly reveals that they can not control at all,

- It is obligatory to reorganize the building inspection system in Turkey and the obligations of the persons who are in charge of the construction phase, and to introduce a new legal regulation regarding the penalties to be given to the persons who are responsible for the technical implementation of the constructions that seem to be inspected on papers but almost never supervised,

- For this purpose; The Decree Law on Building Inspection dated 3.2.2000 and numbered 595, which was issued before, was canceled due to the decision of the Constitutional Court dated 24.5.2001 and numbered E.2001/35, K.2001/90, and therefore, there was no provision in the legislation on building inspection. void formation,

- In order to fill the aforementioned gap in this draft law, to reduce the loss of life and property in natural disasters that may occur by constructing quality and more robust buildings; It was stated that it should be prepared in accordance with the zoning plan, science, art and health rules and legislation, in order to regulate the procedures and principles related to the inspection in order to ensure the quality of the building (Sakallı, 2008). For these reasons, Law No. 4708 on Building Inspection, prepared by the

Ministry of Public Works and Settlement, after the execution of the Decree Law No. 595 on 24.05.2001 was suspended and canceled by the Presidency of the Constitutional Court, was published in the Official Gazette dated 13.07.2001 to enter into force as of 13.08.2001. The Regulation on Construction Inspection Implementation Procedures and Principles, which was issued based on this law, entered into force on 13.08.2001. On 5.2.2008, a new Building Inspection Implementation Regulation was published in the Official Gazette and entered into force. Purpose of the law in the first paragraph of Article 1 of the Law No. 4708 on Building Inspection: “To provide project and building inspection in order to ensure the safety of life and property, in accordance with the zoning plan, science, art and health rules and standards, and to regulate the procedures and principles regarding construction inspection”.

In Article 1 of the Law on Building Inspection, the scope of the Law is defined as follows: “The public buildings and facilities specified in the 26th article of the Zoning Law No. 3194, and the structures that are not subject to the license specified in the 27th article; It covers the inspection of the buildings to be built in and outside the borders of the municipality and the adjacent area, excluding the buildings not exceeding 200 square meters in total.

This law includes the supervision of all private constructions within and outside the boundaries of the municipality and the adjacent area. Inspection work belongs to private building inspection companies as it is in the Law No. 4708 and the Decree Law No. 595. The implementation of this law was started by determining 19 pilot provinces as a priority. In this number, 27 pilot provinces were selected in the Decree Law No. 595. Provinces where the law numbered 4708 will be implemented in the first place; It is expressed as Adana, Ankara, Antalya, Aydın, Balıkesir, Bolu, Bursa, Çanakkale, Denizli, Düzce, Eskişehir, Gaziantep, Hatay, İstanbul, İzmir, Kocaeli, Sakarya, Tekirdağ and Yalova.

With the involvement of private companies in the inspection of the constructions and the entry of the building inspection activity into the field of private law, the conditions that differ in terms of supervision have been adapted, and thus, in a sense, bureaucratic laziness will be avoided. However, this system does not mean that the control is completely transferred to private companies. It is to provide a working environment by joining hands with the public and private sectors in terms of supervision. The new building inspection system also brought with it a cost increase. Making the owner of the building pay for this cost also eliminated the resource problem in this regard. The basic staff of building inspection companies; It consists of supervisory staff consisting of four occupational groups: architect, mechanical engineer, civil engineer and electrical engineer. The

most important condition for the auditor to obtain a certificate is that he is experienced. There is no certification obligation for the technical personnel employed by the building inspection firm and under the direction and direction of the inspectors. The regulation of laws and regulations related to building inspection in our country is carried out by the Ministry of Environment, Urbanization and Climate Change. It is not possible for municipalities to make any changes within the framework of the law. Project (plan and legislation) audit work; While it is carried out by the public sector in Italy, Iran and the USA, it is carried out by public sector and private sector companies in Turkey and Japan. Conducting (technical) supervision of projects; While it is carried out by private sector firm and public sector in Turkey and Japan, it is carried out by a private sector firm or project author in the USA, and by the public sector in Italy and Iran. Issuance of building permit; While it is under the jurisdiction of the public sector in Italy, Iran, Turkey and the USA, it is carried out by private building approval-audit companies in Japan. Construction phase inspection work; It is done by public sector and private sector companies in all of the mentioned countries. Issuing a building occupancy permit; While it is only done by the public in Turkey, the USA, Iran and Italy, it is also done by the building approval-inspection company in Japan (Yağız, 2019).

In European countries such as Germany, England and France, which have established a well-established system, the project authors, engineers and architects are responsible for any damage that may occur in the building for 5-10 years after the completion of the construction (METU Earthquake Engineering Research Center Report, 1998).

Building insurance is obligatory in France, Denmark and the Netherlands, while it is optional in the other countries, and building insurance is a widely used practice. The European building inspection joint venture, which was carried out in 1990 under the leadership of the UK building inspection institute among the member states of the European Union, aims to develop common European-wide objectives regarding building inspection (Yılmaz, 2007).

It is seen that the building inspection system, which was introduced in our country with the law numbered 4708, is a highly qualified regulation when compared with the examples of foreign countries. When compared with other countries, it is seen that there is no significant deficiency other than the insurance application.

4. OCCUPATIONAL HEALTH AND SAFETY IN BUILDING CONTROL

In the 21st century we live in, it is stated that working is 3 times more dangerous than war, while 650,000 people die annually due to wars, 2 mil-

lion people die every year due to work accidents and occupational diseases (Lloy ve Mitchinson, 2008). According to the Social Security Institution Statistics (2008-2012), when the average values of these five years are taken into account, assuming that 8 hours a day, approximately 300 days a year are worked, an average of 24 occupational accidents occur in each working day, and an average of 3 occupational accidents in each 8 hours. According to estimates, the costs faced by countries as a result of occupational accidents and diseases can reach 5% of the general budgets. With the most optimistic approach, it is estimated that the total cost of occupational accidents and diseases to our social security system is 4 billion TL per year. According to the 2007 GDP figures obtained from TUIK, the total cost of work accidents and occupational diseases is approximately 35 billion TL per year (Yılmaz, 2009).

The responsibility of the Building Inspection in terms of occupational health and safety is the only article in the Building Inspection Law No. 4708, which is related to occupational safety and worker health, paragraph f of article 2. This provision does not mean that the Construction Audit personnel will also carry out the duties of the persons responsible for occupational health and safety at the construction site. The purpose of the provisions of the aforementioned paragraph is to give an example, incorrect manufacture of the molds, removal of the molds without setting the concrete, making mistakes in the iron manufacture, faulty manufacture of iron, kiosk and stirrup connection, etc. Column, beam, deck collapse, etc. due to construction-related defects and faulty manufacturing. to avoid dangerous situations. Since such manufacturing errors may endanger the lives of the workers working in the construction and the residents after the construction is completed, it is the duty of the Building Inspection personnel to intervene in such productions, and if the contractor does not take action, the relevant authorities are immediately notified. As mentioned, the purpose of paragraph 2.f is to ensure that a solid and high-quality structure is built in compliance with technical and standards, to prevent damage to life and property due to defects and faulty manufacture of the main productions of the construction, otherwise, the OHS officers' works related to the working conditions and working environment of the employees are also carried out. It is not carried out by its personnel or interfered with their business. The distinctive issue brought by the Building Inspection Law No. 4708 is the possibility that the building itself may cause damage to life or property due to the danger of damage. There is no fault in the main production of the construction, or in other words, cracking, bending, breaking, rupture, buckling, collapse, etc. in the carrier system of the construction. situations that are not dangers are not within the scope of Law No. 4708 and within the scope of building control measures (Okumuş, 2006).

The construction conditions and techniques of the production items carried out in the construction works are actually the OHS measures themselves that must be taken during that production phase. Therefore, the inspection of compliance with the project, specification, science and art rules of many productions carried out in the construction of both private and public buildings by the building inspectors actually includes the inspection in terms of OHS. For example, the inspection of the conformity of the formwork and formwork scaffolding with the project and specification includes the inspection of the conformity of the production to the project dimensions, as well as the standards in terms of the materials used and the rules of science and art in terms of construction technique. As a result of such an effective inspection, due to the duly made formwork and formwork scaffolding, possible accident risks during the construction of these production items and during the pouring of concrete are reduced, in a sense, inspection in terms of OHS is also carried out.

In fact, to the technical personnel who control the production at the construction site; In addition to supervising the compliance of the materials used by the worker in the production with the standards, the project and specification of the production amount, and the conformity of the construction technique to the rules of science and art, it is also given the responsibility of following the insurance of the workers against accidents, reporting them to social security institutions and paying their wages. Within the framework of building inspection laws, building inspection committees are fully authorized to inspect the contractor about the materials used by the workers, the work they have done and their unpaid wages. Occupational accidents could not be reduced despite many legal regulations, since the building inspector, who detects the negligence and weakness of the contractor against unsafe situations and behaviors that endanger the health and even life of the workers, is not considered responsible, authorized and responsible. For this reason, the phrase “warning the building contractor in writing to check that the work is carried out in the workplace in accordance with the health and safety plan that should be arranged in accordance with the occupational health and safety legislation and to take the necessary measures” in the paragraph “f” of the 2nd article of the law numbered 4708 is a very appropriate expression.

It is certain that including this statement in the legal regulations regarding public constructions and the correct follow-up of the application will play a major role in minimizing the accidents in construction. On the other hand, if this issue is followed correctly by the parties, it will not cause a confusion of authority and will create a partial synergy in the projects and create an auto-control mechanism.

Audit responsibility of public structures includes financial responsibil-

ities as well as technical responsibilities. The limitedness of public resources has increased the importance of the concept of cost, and it has become necessary to use existing resources as effectively as possible (Çelik et al., 2003). The construction cost is not just the construction cost. The cost of the building actually covers the entire life-cycle costs of the building, including the design, projecting, construction, use and destruction processes. The most important and most expensive component of the building cost is human health. Especially the production item, which causes loss of life, is invaluable and its cost reaches unbearable dimensions. Considering the OHS criteria at the stages of conceptual design and implementation projects, preparation of Health and Safety Plans together with the projects will prevent possible accident risks in the construction phase before they occur. "According to the risk hierarchy, which has been scientifically proven many times over and supported by the facts, the risks of occupational accidents can be largely eliminated during the project phase by making some changes at a very low cost even in the preliminary design phase of the project, sometimes with a design change, sometimes with additions in the design. In addition to all these, occupational safety is now considered within the life cycle of a building or engineering structure, and even stages such as maintenance, repair, and modification are considered during the design phase (Gürcanlı, 2007). Unless the building inspectors take an active role in the OHS audits of the entire building life cycle, the catastrophic value of work accidents cannot be reduced, and healthier and safer working environments cannot be created.

5. MATERIAL AND METHOD

5.1. The Aim of the Study

The main purpose of the research is; It is the examination and determination of the duties and responsibilities of the building inspection organizations, which have been actively involved in the construction sector, which is the leading sector of the economy, on occupational health and safety. In addition, it has been tried to determine at what level the construction inspection companies perform their inspection duties related to occupational health and safety at the construction site. In addition, in this study, a study was conducted to answer the question of what can be done to make the work related to occupational health and safety made by building inspection companies more effective.

5.2. Universe and Sample of the Study

The universe of this research consists of the main mass of building inspection companies operating in the construction sector in Turkey. The sample of the research consists of 10 randomly selected constructions in the province of Çorum, whose inspection is undertaken by building inspection companies.t

5.3. Method of Study

The checklist method was used in the study. Within the scope of the study, first of all, a checklist was prepared in order for the construction inspection personnel to control themselves and not miss anything in their inspections on occupational health and safety. ELMERİ^{construction} observation forms were prepared using these checklists. Afterwards, ELMERİ^{construction} safety index was calculated by examining the current status of the constructions in terms of occupational health and safety with the prepared ELMERİ^{construction} observation form.

5.3.1. Checklist Method

There should not be any numerical evaluation in the checklist method. The control questions on the list should be evaluated strictly for the sole purpose of determining suitability. Suitable/not appropriate, yes/no, yes/no answers should be sought.

If we briefly list the benefits of using the CheckList method;

- It is determined whether all machinery, tools, equipment and space in a working or living area are suitable or functioning perfectly.
- The items to be controlled related to the subject are prevented from being overlooked.
- Since the questions asked in the CheckLists are suitable for the environment, the deficiencies of the study area are determined.

5.3.2. ELMERİ® Observation Method

The ELMERİ® method is a method that has been actively used in various business lines internationally since the 1990s. To give an example, in the field of metallurgy, about 16 years ago, an occupational safety competition was organized in hundreds of enterprises to support the improvement of working conditions in almost all of them, which lasted for 4 years. The downward movement of the enterprises was observed with a rate of 40% of the losses arising from the accidents (Laitinen et al., 2011). ELMERİ® is a method of increasing occupational health and safety generally used in the manufacturing industry. However, it is a very simple and fast method to be used in different sized work areas. The mentioned method is based on the observation of the conditions in the study area (Laitinen et al., 1999). Observed elements include the purpose of OHS such as the use of personal protective equipment, order and organization, industrial cleaning, equipment safety and ease of use. The ELMERİ® method makes a security level calculation in order to determine the occupational safety level of the entire work site. It is possible that the security rate at the end of the calculation can vary between 0% and 100%. For example;

60% rate; It shows that 6 out of every 10 employees observed comply with the standards and correct working practices related to occupational safety. ELMERİ® is a valid proactive method in determining the level of occupational health and safety. It contains clues to show what the causes of accidents that may occur. ELMERİ® produces numerical data related to how effective the occupational health and safety management organization is. It contributes to the determination of the needs that will increase the development related to occupational health and safety, to the determination of the targets and to the evaluation of the results of the distance covered in the field of occupational safety. For this reason, ELMERİ® method is a method chosen by occupational safety personnel and other OHS-related employees, insurance companies and occupational safety inspectors. This method provides the opportunity to determine the objective data related to OHS in the workplaces and to compare these results with the values of other workplaces operating in the same sector (Laitinen et al., 2011). The ELMERİ® method is a method of observing all important OHS criteria regarding physical work and safety sensitivities. The observed principles are grouped as follows:

- Security behavior
- Order and cleanliness
- Machine safety
- Industrial cleaning
- Ergonomics
- Ground and passageways
- First aid and fire precautions

All elements in the entire work area or in the area designated for evaluation are observed. Observed elements are determined as true or false. If there is an element that was not observed during the said follow-up, or if the observer has doubts about how to evaluate any element, it is stated as no observation. The ELMERİ® safety rate is calculated at the end of the inspection of all previously selected observation zones. Calculation is made as a percentage of the elements with a correct confidence ratio to all observed elements, as in Equation 1:

$$\text{ELMERİ® rate \%} = \frac{\text{True Observation}}{\text{True + False Observation}} \times 100 = \dots \%$$

(Equation 1)

The front and back sides of the ELMERI^{construction} observation form, which was developed for use in construction by building inspection companies prepared within the scope of this study, are given in Table 1 and Table 2 (Erdal D., 2022). The ELMERİ observation form used in the manufacturing industry cannot be used in constructions due to the different working environments of the constructions. Therefore, within the scope of this study, an observation form was developed specifically for building inspection companies to use in construction (Erdal D., 2022). The main reason for the need to develop a re-form in the construction sector is that some observation fields and activities required for construction are not available in the standard observation form used for the manufacturing sector, or that many elements that are very important for the construction sector in terms of occupational health and safety are not sufficient in the standard observation form used for the manufacturing sector. not so emphasized.

Table 1. *The front side of the ELMERI^{construction} observation form prepared for construction (Erdal D., 2022).*

ELMERI^{construction} Observation Form				
Construction Name				Date
Construction Address				
Controller				
Control Place				
Topics	True	False	No Observations Made	Description
1. OHS BEHAVIOR EDUCATION				
1.1 PPE Status				
1.2. Using PPE and Risk Situation				
1.3. Professional Competence				
1.4. OHS Training				
2. ORGANIZATION, ORGANIZATION AND CLEANING				
2.1. Material Stack				
2.2. Construction Waste Management				
2.3. Construction floor floors and passageways				
3. MACHINE CONDITION				
3.1. Machines used in construction				
3.2. Machines and emergency stop buttons				
4.PHYSICAL, CHEMICAL AND BIOLOGICAL FACTORS				
4.1. Sound Status				
4.2. Adequacy of Lighting				
4.3. Ambient Air and Temperature				
4.4. Chemicals				

5. ERGONOMICS				
5.1. Studies on the skeletal system				
5.2. Employee position and work area				
6. GROUND, TRANSITIONS AND ACCESS CONDITIONS				
6.1.Ladders				
6.2.Elevators				
6.3. Shaft and Ventilation Spaces				
6.4. The structure of the ground and passageways				
6.5. Windows				
6.6. Floors				
7. ELECTRICITY, FIRE AND FIRST AID				
7.1. Construction Site Electrical Panel				
7.2.Electrical Devices				
7.3.First Aid Cabinet				
7.4.Fire Extinguisher				
7.5. Emergency Exits				
8. SCAFFOLDS				
8.1. Facade Piers				
8.2. Scaffolds Used in Construction				
9. CONSTRUCTION SITE				
9.1. Safety and Warning Signs				
9.2. Material Stacking				
9.3. Construction Environment				
TOTAL				
True				
ELMERI^{construction} Rate = ----- x				
100 =				
True + False				

Table 2. Back side of *ELMERI^{construction}* observation form prepared for construction (Erdal D., 2022).

ELMERI^{construction} Observation Rules

Topics

Considerations for Correct Scoring

Topics	Considerations for Correct Scoring
1. OCCUPATIONAL HEALTH AND SAFETY BEHAVIOR AND TRAINING	
1.1. PPE Status	* PPE available in construction
1.2. Using PPE and Risk Situation	*Workers benefit from the necessary personal protective equipment and do not work in a risky way.
1.3. Professional Competence	* Workers have a professional qualification certificate
1.4. OHS Training	*Workers receive the necessary OHS training
2. ORGANIZATION, ORGANIZATION AND CLEANING	
2.1. Material Stack	*Materials used in construction are stacked in a way that does not hinder and pose a danger to other workers.
2.2. Construction Waste Management	*Construction wastes are removed regularly
2.3. Construction floor floors and passageways	*Floor floors are cleaned, tidy, spilled oil, paint, etc. on the floor. none * After the mold removal process, nails, molds and iron parts on the floor are cleaned.
3.MACHINE CONDITION	
3.1. İnşaatta kullanılan makineler	*Fixed, stable for use, no damage, visible on safety signs, machine guards available and working undamaged
3.2. Makineler ve acil durdurma butonları	* Position, signs and warnings are legible and in Turkish, emergency stop buttons are available in case of emergency
4.PHYSICAL, CHEMICAL AND BIOLOGICAL FACTORS	
4.1. Sound Status	*Noise at construction site <85dB(A)
4.2. Sufficiency of Lighting	*There is sufficient lighting for indoor and night work.
4.3. Ambient Air and Temperature	*The fresh air condition is sufficient for the workers in the construction, there are regional ventilations if necessary, the temperature, humidity and air flow are in good condition
4.4. Chemicals	*Package and boxes are undamaged, have name and security labels, chemicals are transported safely and cleanly
5. ERGONOMICS	
5.1. Studies related to the skeletal system	*Loads that cannot be lifted with human power cannot be lifted with physical force, *Body position is taken correctly in lifting works that require physical strength
5.2. Employee position and work area	*The working area is sufficient, the tools and materials are suitable, the seat and working height can be adjusted, the tools and equipment are ergonomically designed

6. GROUND, TRANSITIONS AND ACCESS CONDITIONS	
6.1.Ladders	*If working at a height of more than 0.5 meters, appropriate measures have been taken to prevent falls. * Railings have been made on the stairs in the construction * Appropriate stairs are used to reach high places
6.2.Elevators	*Intra-construction elevators are properly closed to prevent falling.
6.3. Shaft and Ventilation Spaces	*After formwork removal, all cavities are properly covered to prevent falling. * Walking and access roads are of sufficient width and height, marked and separated where necessary for pedestrian and vehicle traffic.
6.4. The structure of the ground and passageways	* There are no materials preventing the passage of workers etc. on the passageways.
6.5. Windows	*Precautions have been taken to prevent falling into French window openings.
6.6. Floors	*After the mold removal, precautions are taken to prevent falling on the floor edges.
7. ELECTRICITY, FIRE AND FIRST AID	
7.1. Construction Site Electrical Panel	*Precautions are taken against leakage current in the electrical panel, sockets are covered, 0.8 meters of free space is left in front of the panel.
7.2.Electrical Devices	*Electrical installations and electrical equipment are in good condition
7.3.First Aid Cabinet	* All first aid materials are available against accidents and injuries,
7.4.Fire Extinguisher	*There is a fire extinguisher in an easy-to-reach place and easy to use, inspected
7.5. Emergency Exits	*Available, free, visible in case of power failure
8. SCAFFOLDS	
8.1. Facade Piers	* Suitable for scaffolding project
8.2. Scaffolds Used in Construction	* Scaffolding parts are solid and controlled *Fixed in accordance with the construction and in number *Spa pier etc. scaffolds used
9. CONSTRUCTION SITE	
9.1. Safety and Warning Signs	*Warning signs available and legible inside and outside the construction
9.2. Material Stacking	* At the construction site, the materials are stacked in such a way that they do not interfere with other works and employees.
9.3. Construction Environment	*Security measures have been taken to ensure that there is no entrance to the construction site except for the personnel in charge.

5.3.2.1. Selection of Observation Areas

5.3.2.1.1. Comprehensive observation

Where the method is used by the entity as an audit method and guidance element, a large-scale review is required. It is expected that the inspection time in any region will be approximately 10 minutes on average. A large part of the areas in a not very large enterprise with access roads, stock areas and other areas, and the whole of the working parts in a field in a larger workplace should be able to be observed quite easily. The degree of reliability of the safety ratio obtained in such wide-ranging observations is expected to be quite high (Laitinen et al., 2011).

5.3.2.1.2. Observation of sample areas representing the workplace

Although there is not enough opportunity to observe the whole workplace, accurate results can be obtained showing the level of occupational health and safety in the workplace. In such cases, it is obligatory to choose representative areas that show the divisions of work to be used for observation. The following elements should be considered in the mentioned areas: all works in the enterprise, access roads, vehicle roads and connection roads, storage areas, garbage recycling areas and surrounding areas. In order to reach a conclusion with certain accuracy, an average of 7 business regions should be preferred. About 100-150 observations will be made here. Before determining the observation areas, the various working zones operating in the workplace should be determined. In multi-employee jobs, status checks should be made from as many work areas as possible. For example, if there is more than one ironworking workshop, one workshop can be randomly selected for observation. However, if there are many sections in the enterprise, enough observation areas should be selected from each section. Differences between departments should be considered during selection (Laitinen et al., 2011).

5.3.2.1.3. Limits of the observation area

It should be determined where the area to be observed will be. The purpose here is to determine the selected region with a worker or during the work (eg construction floors, inside and outside of the construction, construction site, workers who manufacture walls, etc.). It is more convenient to choose small observation zones instead of large ones; because it makes it easier to observe. It will be more useful to examine a large production machine in smaller sections and to observe these sections one by one.

5.3.2.2. Evaluation of Occupational Health and Safety Conditions

After the determination of the area to be observed and the determination of its borders, the evaluation process begins. All the steps from begin-

ning to end should be evaluated in order during the filling of the observation form. Thus, it is prevented that the “correct” elements, which is a very common problem when learning the method, are not overlooked. Most of the time, the right elements are likely to be overlooked in occupational safety-related controls; however, these issues need to be expressed in order to achieve a reliable safety rate during ELMERİ® observations. It is good practice to state this point by making short notes. Otherwise, it is highly likely that the “wrong” elements will be forgotten for what reason they are wrong. It is a very effective type of application in keeping records by taking pictures during the observation. The fields are followed according to the order in the list, then the other field can be moved (Laitinen et al., 2011).

5.3.2.3. Reporting of ELMERİ® Observation Form Results

The ELMERİ® observation method can be applied in many different ways, and some changes may be observed during its reporting. A comprehensive management report should examine the following items:

- Title and address information of the examined business
- Date and period of the review
- Experts and people participating in the review
- Inspected sections (observation zones)
- Results; number of observations, rate and lower rates
- Written version of good practices
- Written version of the applications to be done
- Photos taken during the observation

The ELMERİ® method can be repeated at certain time intervals in the enterprise. The aforementioned application is very beneficial for the continuous performance and application control of all workers. Employees should be told how the method is done. It would be better if the general data obtained as a result of the observation should be posted in a place where workers can see it; Thus, employees have the chance to see and compare the previous rates together with the current safety rate. In this way, the workplace can reduce the security risks that may arise in the future, and it is ensured that the employees participate in the improvement works (Laitinen et al., 2011).

6. RESULTS

In business life, people are faced with a large number of potential risks that can endanger their health. Although the level of importance differs according to the nature of the work done, there are many different security risks in all working environments. Related to this, as a result of this study, it is aimed that the building inspection companies working in the construction sector are aware of their responsibilities in terms of occupational health and safety, and that the necessary inspections are carried out in order to continue the construction activities in a healthy and safe environment in terms of not only the soundness of the structure but also the occupational health and safety. Building inspection companies generally carry out occupational health and safety inspections by means of engineers, architects or technical assistant personnel. However, the obligation to employ and employ a qualified occupational safety specialist in the construction and manufacturing department, who, as the relevant inspection personnel, will have more information about occupational health and safety, will enable the occupational health and safety culture to be formed faster and to be more qualified (Erdal). D., 2022).

7. REFERENCES

- Acikel, D.A. (1998). The Effect of Building Inspection on Quality and the Case of Konya. (Thesis No.78725) [Master's Thesis, Selcuk University]. YÖK National Thesis Center,
- AFAD: Technical information about earthquakes, TR Prime Ministry Disaster and Emergency Management Presidency, Directorate of Earthquake Administration, 2011./blackboxPlease add further information.
- Bilik, M. B. (2015). A Sociological Analysis on the 2011 Van Earthquakes. (Thesis No. 381315) [Master Thesis, Yüzüncü Yıl University]. YÖK National Thesis Center
- Celik, M. H., Evidence, R. and Baykan, U.N. (2003). Determining the Relationship Between Estimated Cost and Actual Cost in Public Building Constructions, *Journal of Polytechnic*, 6(4). 677-692. <https://www.acarindex.com/pdf/acarindex-f1882a94-2f5c.pdf>
- Cogurcu, M. T. (2015). Construction and design defects in the residential buildings and observed earthquake damage types in Turkey, *Nat. Hazards Earth Syst. Sci.*, 15, 931–945.,
- Dogan, A. (2013). A Field Study on the Inspection of Building Inspection in Ankara. (Thesis No. 330683) [Master's Thesis, Gazi University]. YÖK National Thesis Center
- Erdal, D. (2022). Responsibilities of Building Inspection Firms in terms of Occupational Health and Safety. (Thesis No. 761039) [Master's Thesis, Hitit University]. YÖK National Thesis Center
- General Directorate of SSK, (2005-2009). Statistical Annuals, Ankara.
- Gürcanlı, G. E. (2007, October 21-23). "Design for Occupational Safety as a New and Mandatory Concept. [conference presentation summary]. 3. Occupational Health and Safety Symposium. Canakkale, Turkey
- Health Security Institution, (2008-2011). Statistical Annuals, General Directorate, Ankara.
- Karaesmen, E., İzmir, H., & Boyacı, N. (1989). Supervision Liability and Insurance in the Building. İntes Publications.
- Kural, R. (2015). Building Inspection in Construction Sector and Investigation of Applications in Afyonkarahisar Province. (Thesis No. 413295) [Master's Thesis, Afyon Kocatepe University]. YÖK National Thesis Center
- Laitinen, H., Ersan, E., Birgören, B. and Özesen, M. (2011). Project for Improving Occupational Health and Safety at Work in Turkey, Europe Aid/127926/D/SER/TR.
- Laitinen, H., Rasa P, L., Räsänen, T., Lankinen, T. & Nykyri, E. (1999). ELM-ERİ® observation method for predicting the accident rate and the absence due to sick leaves, *American Journal of Industrial Medicine*, 36(1), 86-88.

<https://pubmed.ncbi.nlm.nih.gov/10519796/>

Law No. 4708 on Building Inspection

Lloy, J. and Mitchinson, J. (2008). Filiz, C. and Ergüven E. (Ed.), The Book of Ignorance (10th Edition), NTV Publications.

METU Earthquake Engineering Research Center Report (1998). Revision of the Zoning Law No. 3194 and Regulations Including a New Building Control System and Resilience Against Disasters

OHS Law (2012). OHS Law No. 6331, Official Gazette dated 30.06.2012 and numbered 28339

Okumus, E., (2006). Building Inspection is only the Inspection of the Quality of the Building. Chamber of Civil Engineers Turkey Engineering News, 1(441). 37-39. <https://eskisakarya.imo.org.tr/resimler/ekutuphane/pdf/50.pdf>

Republic of Turkey Ministry of Labor and Social Security, (2016). Construction Sector Occupational Safety Handbook, (Publication No: 44), Ankara. https://www.csgeb.gov.tr/medias/6002/2011_44.pdf

T.C. Ministry of Labor and Social Security, Labor Inspection Board. Research Report. "The Report on the Analysis of Fatal Occupational Accidents in the Construction Sector and the Evaluation of Statistical Information for the Years 2014, 2015 and 2016".

Tozkoparan, G. and Taşoğlu, J. (2011). A Research on Determining the Attitudes of Employees Regarding Occupational Health and Safety Practices, Uludag University Journal of the Faculty of Economics and Administrative Sciences, 30(1), 181-209.

WHO (2001). "Occupational health: A Manual For primary health care workers", [Www.Who.Int/Occupational_Health/Regions/En/Oehemhealthcareworkers](http://www.who.int/occupational_health/regions/en/oehemhealthcareworkers).

Yağız, S. (2019). Building Inspection Practice in Turkey and Its Effect on Housing Quality: Bursa Field Study. (Thesis No. 542026) [Master's Thesis, Bursa Uludag University]. YÖK National Thesis Center Building Inspection Implementation Regulation, (Regulation Number: Official Gazette No. 26776; Date of Acceptance: 5.2.2008).

Yilmaz, F. (2009). Occupational Health and Safety in the European Union and Turkey: Measuring the Efficiency Level of Occupational Health and Safety Boards in Turkey. (Thesis No. 261926) [PhD Thesis, Istanbul University]. YÖK National Thesis Center

Yilmaz, H. (2007). Building Inspection and Building Inspection Agencies, Yetkin Publications.

Zoning Law No. 3194 Official Gazette No. 18749 dated 03.05.1985

“

Chapter 4

**COMPARISON OF GEOGRAPHICAL
INFORMATION SYSTEMS (GIS) WITH
INTELLIGENCE TRANSPORTATION
SYSTEM (ITS) IN INDIA AND JAPAN**

Hatice Cana GÜNGÖR¹

Abdinasir Osman MOHAMED²

”

1 Dr.Öğ.Üy. Necmettin Erbakan Üniversitesi Meram MYO Mülkiyet Koruma ve Güvenlik Bölümü ORCID: 0000-0002-5563-9552

2 Yüksek Lisans Öğrencisi Necmettin Erbakan Üniversitesi Fen Bilimleri Enstitüsü ORCID: 0000-0002-9537-2688

INTRUDUCTION

This article will make comparisons of intelligence transport between Japan and India and focus on how they are used. As we know, these two countries are among the countries that use ITS, especially traffic management, air pollution, mobility, safety, road accident or injury caused by collision and environment, this paper will focus on how they use it especially when it comes to using ITS and a comparison will be made in terms of ITS. Traffic congestion is a major issue all around the world. The Intelligent Transportation System (ITS) enables us in overcoming these issues using advanced technology and systems. Intelligent Transportation Systems utilize computer, electronic, and telecommunication technology and management systems to increase the safety and efficiency of road passengersto control and manage traffic bottlenecks. We shall look at Intelligent Transportation System technology in this study. The aim of the article is to assess the intelligent transportation system by making comparison between India and Japan in intelligent transportation system. Therefore, past years' structural design and urbanized models of many branches of ITS are introduced here to make a comparative analysis of India and Japan's Intelligent Transport System. It will assist in raising awareness of issues that can be researched properly. The guide includes available chances to see the outcomes of transportation system research while also making it more usable and effective in transportation system. When it comes to using ITS in Japan and India, Japan is ahead. Because Japan has implemented all the ITS services while India is still in the process of implementing the service, for instance Japan has one of the most advanced public transit systems while India lags behind due to the lack of innovative technology in India. Japan's Shinkansen bullet trains are incomparable to India's Standard Gauge Railway. When we look at the number of accidents, there have been more than 300 accidents in India in the last 5 years, while no accidents have occurred in Japan especially when it comes to the Shinkansen bullet trains.

INTRODUCTION IN GENERAL INTELLIGENT TRANSPORTATION SYSTEMS(ITS)

Intelligent Transportation Systems (ITS) are such a comprehensive control, data, and communication improvement to existing transportation and traffic systems; transportation safety and security, providing more comfortable travel for passengers, reducing pollution, etc. ITS, has led to a sharp decline in congestion and pollution. This system has led to improvements in transport efficiency, safety and security of passengers and property. This has also been proven by numerous ITS-related programs and projects around the world. Intelligent Transportation System replaced the concept used to solve transportation problems previously used. The increase in transportation-related problems in all major cities, centres or airports increases the need for

new approaches and new solutions.(Mandžuka, 2015).

LITERATURE REVIEW

Intelligent Transportation System (ITS) is described as a broad range of potential data and computer applications to road and transportation networks. Shah and Lee (2007), quoted by Kamarudin et al (2009). Intelligent Transportation Systems (ITS) are trying to cut ways to decrease traffic congestion, improving, and improving environmental quality that are based on data networking, and satellite technology. ITS enhances the world's transportation infrastructure significantly since it lets the parties concerned to manage mobility in traffic management more better in the future.(Changlun, n.d.).

The state of the transportation system is modifying rapidly as a result of progressions in various fields and the adoption of new technologies such as computing hardware, positioning systems, sensor technologies, telecommunications, data analysis, virtual execution, and system planning techniques. Intelligent Transportation System offers cooperation tools along with a reliable transportation platform. Airway and Highway Management, Cargo Management, Transit Management Systems (TMS), Incidence and Emergency Management Systems, Regional Multimodal and Passenger Information Systems, and Information Management (IM) Systems are main aspects of ITS in urban regions.Many systems play a crucial role in the ITS business, including electronic toll collection (ETC), highway data collection (HDC), traffic management systems (TMS), vehicle data collection (VDC), transit signal priority (TSP), and emergency vehicle prevention. (EVP), and so forth. Various techniques of transmission are utilized for various applications; some work in long-distance transmission, some in small distance communications, and some devices use radio modem transmission to gather computerized information for analysis and presentation. (Qureshi & Abdullah, 2013).(Vanderschuren & De Vries, 2013).

ITS IN INDIA

Quickly growing towns run city buses and always expand the roadways to accept greater vehicles, which assists in reducing traffic jams. Nagpur seems to have a metro system. Bus, rail, metro, BRT, and LRT routes with fast speed, consistency, safety, efficiency, services, and security are used for transportation. System of Passenger Information (PIS). Security Camera Network System (SCN), Bus Driver Console (BDC), On Board Ticketing Machines, Central Control Centre Online ticket booking, vehicle booking via applications(Review, 2019).

The Traffic Management Centre (TMC) is the automotive organisation center where data is collected, analysed, and merged with some other

functional and management thoughts in order to cope with imagination transportation requirements. A platform where mobility data is conveyed to the public and the press public, as well as where groups can coordinate and advise their action to transportation terms and circumstances. Typically, many canters contribute the organization of the transportation basis via a road network on which managers relate.(Djalalov, 2013).

ITS Apps are utilized for traffic control. The apps listed herein are recognized by India Traffic.

- Control of intersections
- Incident monitoring
- Vehicle identification monitor and review
- Revenue
- Pedestrian flow data

Basic Requirement of ITS for India is: -

Intelligent Transportation Systems (ITS) aims to add information and communication technology to transportation infrastructure and vehicles to improve:

- Safety
- Reliability
- Efficiency
- Quality of means of transport(Al-Zu'bi et al., 2010).

ITS-Japan

Toyota Electro Crown model, Cathode Ray Tube to view map, Vehicle-based navigation system, Rotating throttle rate as Orientation sensor. The very first step includes the use of electronic toll collecting and in-vehicle navigation systems. Second phase (2005): Rescue efforts and swift emergency response. The development of public transportation organizations, along with information systems, promote transportation efficiency. The third stage (2005-2010) includes updates to in-vehicle infrastructure and equipment. Initiation Phase (starting after 2010): Telecommunications technology and developed based and, Comprehensive optical fiber network, acquired traffic data, Universal Traffic Management System (UTMS), and two-way infrared approach systems for traffic signal forecasting (TSPS) TSPS promotes responsible and safe driving by giving drivers with driving required information based on their knowledge of traffic light colours.(3 . *Intelligent Transport System (ITS) Developed by the Japanese Police*, n.d.).

The Comprehensive Plan includes nine R&D areas and twenty user services.

R&D area	User services
1. Improvements in navigation systems.	1) Traffic information provision. 2) Distribution of travel information.
ETC (Electronic Toll Collection) systems.	3) ETC
3. Help for driving safety.	4) Provide information about the driving environment. 5) Hazard alerts. 6) Assistance in driving. 7) Driverless cars.
4. Better traffic management.	8) Increased traffic flow. 9) Disseminating traffic control information following traffic incidents.
5. Improved road traffic management efficiency.	10) Increased efficiency in road maintenance/management. 11) Special vehicle management. 12) Distribution of traffic control information.
6. Assistance for public transportation operations.	13) Dissemination of information about the use of public transportation. 14) Assistance with public transportation operations/management.
7. Increased efficiency in commercial vehicle operations (CVO).	15) Help with commercial vehicle operations. 16) Unrestricted automated commercial vehicle driving.
8. Support for pedestrians.	17) Navigation assistance. 18) Hazard avoidance.
9. Assistance with vehicle operations during crises.	19) Automated emergency notification 20) Emergency vehicle route direction and recovery assistance.

These are the nine ITS give a sense that Japan has created.

1. Navigation System Advances
2. Electronic toll collection
3. Driver assistance
4. Optimization of Traffic Management
5. Improving Road Work Efficiency
6. Support to Public Transportation
7. Improving Commercial Efficiency
8. Pedestrian Assistance
9. Assistance with Disaster Response

COMPARISON IN INDIA AND JAPAN:

First and foremost, there is a huge disparity when it comes to how the two countries have harnessed these systems when it comes to railway and road transport. I will also compare how these systems have been deployed in sea and air transport in subsequent paragraphs.

Japan has one of the world's highest intelligence transport systems beating North American and European standards. I will be making comparisons between India and Japan in terms of the quality of services provided by their transportation dockets, frequency, reliability and availability of their various modes of transport, the safety standards, traffic congestion time loss, implementation of the integration between geographical information systems and intelligence transportation systems. I will further examine traffic signals in both countries Management by Origin-Destination Related Adaption for Traffic Organization (MODERATO) system.

The quality of services in Indian railway transport is of low quality as compared with Japan because the Indian trains are usually overcrowded and there is virtually no space for everyone. These trains and metros are unhygienic, and most passengers have to travel in untidy coaches which is a health hazard. People usually spit, dispose garbage among other unhealth acts which makes the journey uncomfortable. Whereas in Japan, their bullet trains are kept tidy through passenger discretion and initiative.

The availability of trains and metros in India and Japan are quite different. The Indian trains and metros are available at a frequency of 10-15 minutes during peak hours while those in Japan are usually available 3 to 5 minutes during peak hours and 10 minutes during regular hours. From these we can deduce that Japanese rail transport is more reliable as com-

pared to India. Indian trains are usually unreliable since they get to the stations very late and without explanations, meanwhile in Japan, the trains are punctual and efficient. The train company apologizes for delaying a departure or arrival by mere twenty seconds late. The Japans railway system is service-oriented and reliable because it puts the satisfaction of the passenger above everything else.

Indian Train Speed are lower compared to the speed of Japanese trains. There are no highspeed trains in India. The fastest Indian train travels at 200 kilometres per hour while Japan has started trial of its 400 kilometre per hour. The Indian trains are cheaper compared to those of Japan.

Traffic congestion time loss in India is more compared to Japan because Japan has Cruise Control Systems on public roads. Japan has already a system in place to reduce road traffic by adapting Management by Origin-Destination Related Adaption for Traffic Organization (MODERATO) system while India has been importing this system from Japan through Japan International Cooperation Agency. This further elucidates that Japan is superior in terms of traffic control as compared to India. The overlong traffic congestion in India leads to high emission of CO₂ which leads to environmental degradation. India is yet to implement Dedicated Short-Range Communication Systems on its roads while Japan has done so in 2009. India recently implemented Electronic Toll Collection while Japan implemented it in 1997.

CONCLUSION

Finally, when comparing these two countries, they are worlds apart when it comes to Intelligent Transportation System and clearly Japan is more advanced than India in terms of invention and innovation in the transportation field as well as the utilization of these systems. Japan is one of the most advanced countries in terms of technology which makes it easy to use various services related to ITS.

Traffic rules and management is highly enforced in Japan as compared to India because Japan uses Management by Origin-Destination Related Adaption for Traffic Organization (MODERATO) which provides information and enhance traffic control. India lacks an advanced cycling infrastructure, and this makes cyclists prone to accidents since they will be sharing the road with motorists as well as pedestrians on footpaths.

Policies regarding transportation are crafted to meet the needs of the people and this can be felt through the state-of-the-art public transit systems in Japan for instance the Shinkansen trains. The waiting time for the bus is longer in India and shorter in Japan, according to the station screen. Japan's public transport is service-oriented and citizen centric which sets it apart from India's public transport system.

REFERENCE

- Al-Zu'bi, R. S., Al-Hiyari, A. M., Samamah, E. A., Malas, M. I., Ahmad, A., & Salameh, W. (2010). Intelligent transportation system in Jordan. *17th ITS World Congress*, 6(6), 77–80.
- Changlun, M. (n.d.). *A Study on Intelligent Transport Systems (ITS) For the Safety of*. 1–7.
- Djalalov, M. (2013). The role of intelligent transportation systems in developing countries and importance of standardization. *International Telecommunication Union - Proceedings of the 2013 ITU Kaleidoscope Academic Conference: Building Sustainable Communities, K 2013*, 253–260.
- Intelligent Transport System (ITS) Developed by the Japanese Police*. (n.d.). 7, 210.
- Mandžuka, S. (2015). *Intelligent Transport Systems: Selected Lectures*.
- Qureshi, K. N., & Abdullah, A. H. (2013). A survey on intelligent transportation systems. *Middle East Journal of Scientific Research*, 15(5), 629–642. <https://doi.org/10.5829/idosi.mejsr.2013.15.5.11215>
- Review, L. (2019). *An Overview on Indian ITS & Foreign ITS to Develop ITS in Nagpur City*. 4(1), 17–21.
- Vanderschuren, M., & De Vries, D. (2013). Advanced public transportation information provision: What are the effects on improved customer satisfaction? *IEEE Conference on Intelligent Transportation Systems, Proceedings, ITSC, Itsc*, 499–504. <https://doi.org/10.1109/ITSC.2013.6728280>

“

Chapter 5

DETECTION OF SHIPS USING SENTINEL-1 SYNTHETIC APERTURE RADAR IMAGES

Muharrem Hilmi ERKOÇ¹

”

¹ Dr., Yıldız Technical University, Faculty of Civil Engineering, Department of Geomatic Engineering, <https://orcid.org/0000-0003-4855-0071>

1-INTRODUCTION

Coastal regions are important in many aspects in that they provide access to raw materials, coastal biodiversity, sustainability of tourist facilities, security of coastal cities and transportation. Sea level, tides, population, pollution, biodiversity, fishing and ship monitoring need to be taken into consideration in coastal areas. Ship monitoring is carried out for many purposes such as maritime traffic control, feasibility of new facility, possible sea border violations, illegal fishing, oil/natural gas search/exploration or leak detection. Currently, monitoring and remote detection of ships can be performed easily using satellites. In addition, based on the decision of International Maritime Organization (IMO) and the Maritime Safety Committee (MSC), in accordance with the International Convention for the Safety of Life at Seas (SOLAS), the contracting states are required to be included in the Long-Range Ship Identification and Tracking (LRIT) system. In addition to continuous monitoring of ships, contributing to ship navigational safety, and supporting search and rescue operations, this system provides solutions to issues such as hydrographic information (depth, tide, current direction, datum) and meteorological information (wind direction and force, weather condition, water temperature, wave data) that can be scientifically useful to central points, such as navigational-sea information flow and navigational safety.

Another important characteristic of ship monitoring at sea is the detection of possible bilge wastes. Bilge waste is the leakage or oily water that occurs in parts of ships such as machinery tanks and hatches. These wastes can pollute the seas and harm marine life in the area. Ship monitoring allows detection of how and by which ships these wastes are released into the sea. Today, as well as sea vehicles, unmanned aerial vehicles and synthetic aperture radar images are also used to detect these wastes. Synthetic Aperture Radar is a system that synthetically simulates the huge antenna and aperture as a result of its internal mechanism, has an orbit and obtains high resolution images (URL1). Phase and signal magnitude information of successive pulses from the components of the synthetic aperture are used to process the signals. After an adequate amount of cycles (satellite transit, image acquisition) a high resolution image of the earth are generated.

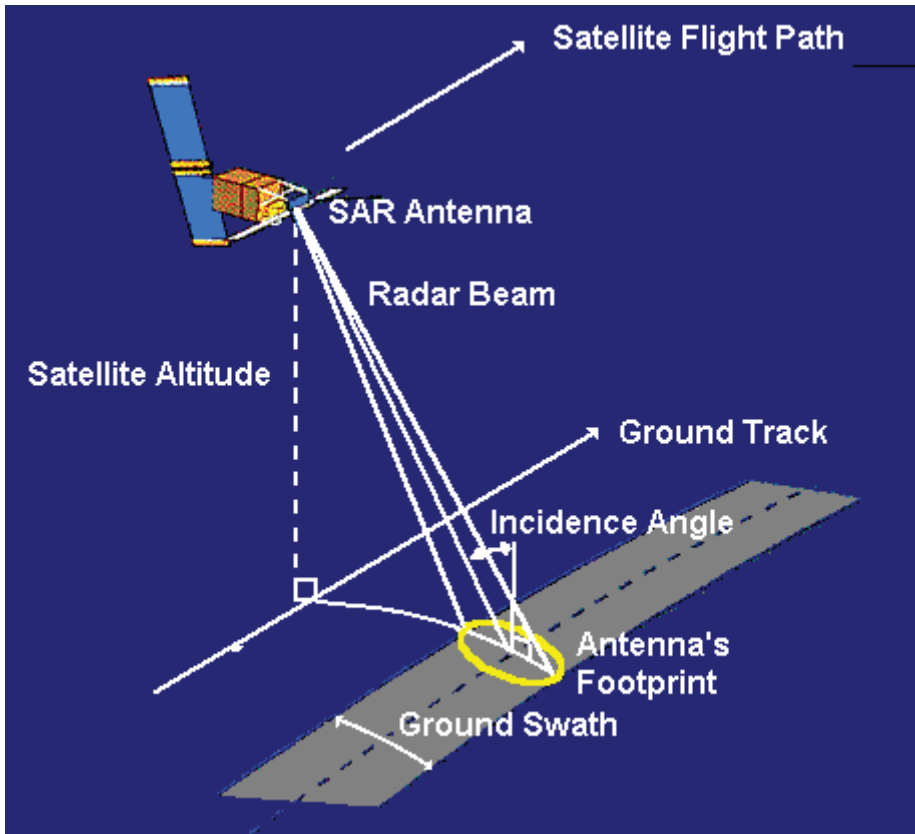

Figure-1 Synthetic Aperture Radar (URL1)

Synthetic Aperture Radar are frequently used. Although detecting the damage after a forest fire takes months in physical conditions, results can be obtained within hours using synthetic aperture radar images. Belenger-Plomer et al. (2019) developed a burned area matching algorithm using synthetic aperture radar and tested the algorithm they developed in four regions, three in Amazon basin and one in the Iberian Peninsula. It is a well-known fact that the yield of cultivated agricultural crops has decreased due to global warming, which requires estimating the yield in agricultural products and controlling the process. The cultivation, growth and harvesting of agricultural products are monitored using synthetic aperture radars. Liu et al. (2019) concluded that synthetic aperture radar will play a more significant role in monitoring the cultivation in agricultural areas. In addition, hurricanes and storms are more frequent in the Americas. Changes in waterlogged areas after hurricanes and storms lead to floods. In 2017, Hurricane Irma caused several floods in Florida, United States. Nagai et al (2021) analyzed the synthetic aperture radar images before and after the

flood in order to detect the effects of the Hurricane Irma, reduced the water surface uncertainty using the NoBADI method and concluded that it would contribute to rapid decision-making in the time of crisis (disaster etc.). The interpretation of synthetic aperture radar using interferometric information is called InSAR. It is used to detect earthquakes, landslides, subsidence or uplift movements in any part of the world. The Mexico City subsidence map, prepared by the European Space Agency as a part of the INSARAP project, was produced using synthetic aperture radar images. It was reported in the project that the causes of subsidence in the region were due to groundwater withdrawals (INSARAP, 2014). Sea level is determined using satellite altimeter and tide gauge data. Since tide gauge data estimate sea level based on a local reference system, it is subject to vertical crustal movements. Satellite altimeter is independent of this effect. In order to compare tide gauge and satellite altimeter data, vertical crustal correction should be applied to tide gauge data. Sentinel-1 synthetic aperture radar images were evaluated to determine the vertical crustal movement on the Aegean and Mediterranean coasts of Turkey, and the sea level values estimated based on the tide gauge and satellite altimeter data in the study area were compared with each other (Erkoç et al., 2022). Synthetic aperture radar images are also used in the detection of ships and objects in the sea. Iervolino et al. (2015) developed a new approach for detecting ships using synthetic aperture radar images and tested it in Portsmouth harbor. Satellite images are extensively used in monitoring the seas due to the fact that they are easily accessible, reliable and less laborious to process. Here, the temporal resolution of optical satellite images has a temporal resolution of 5-6 days, and synthetic aperture radar images have a temporal resolution of several days. Thus, it is more sustainable to monitor and detect both ships in motion and ships in port or in the open sea.

2-METHODOLOGY

2.1 Mathematical Expression of Detection of Ships Using Synthetic Aperture Radar

Due to the high resolution of the images, synthetic aperture radar is very advantageous in ship detection, maritime traffic monitoring and management of marine resources compared to optical images. Today, there are synthetic aperture radar systems such as Sentinel-1, TerraSAR-X, ALOS and Gaofen-3. There are various ship detection studies using all of these systems (Iervolino et al., 2015; Zhou et al., 2022). Constant False Alarm Rate (CFAR) is the most frequently used method for ship detection using synthetic aperture radar images. In the CFAR, two main components are used: the appropriate clutter model and a detector (Xing et al., 2009). In this approach, the object corresponding to the relevant pixel is exposed to an inspection such as Pixel Under Test (PUT) to prevent it from being

something other than the ship. These values differ based on the studied region and are local values.

Possible errors (PFA) in pixel values due to waves in the sea are removed with a threshold value (T_r) produced as a result of the analysis (Equation-1).

$$PFA = 1 - \int_{-\infty}^{T_r} p_A(A) dA = \int_{T_r}^{\infty} p_A(A) dA \quad (1)$$

In the solution of PFA , sometimes problems may occur in analytical operations. In order to remove this problem, better results can be obtained by saving time by applying the Gaussian Model represented by (2) to the Equation (1). (Crisp, 2004).

$$T_r = \sqrt{-\sigma_s \ln(PFA)} \quad (2)$$

Here T_r is threshold value adjusted based on PFA, and all PUT values above this value indicate the ship to be detected. σ_s is the mean power of pixel uncertainty in the sea. The decision threshold value in detecting ships using CFAR is determined by Global threshold algorithms and Adaptive threshold algorithms approaches (Iervolino, 2016).

2.2 Ship Detection Algorithm using Synthetic Aperture Radar

The algorithm in Figure-2 can be used to detect ships using a synthetic aperture radar image. Here, the most important steps are removing noises, applying the orbit files, selecting the thresholdings and removing the objects, respectively.

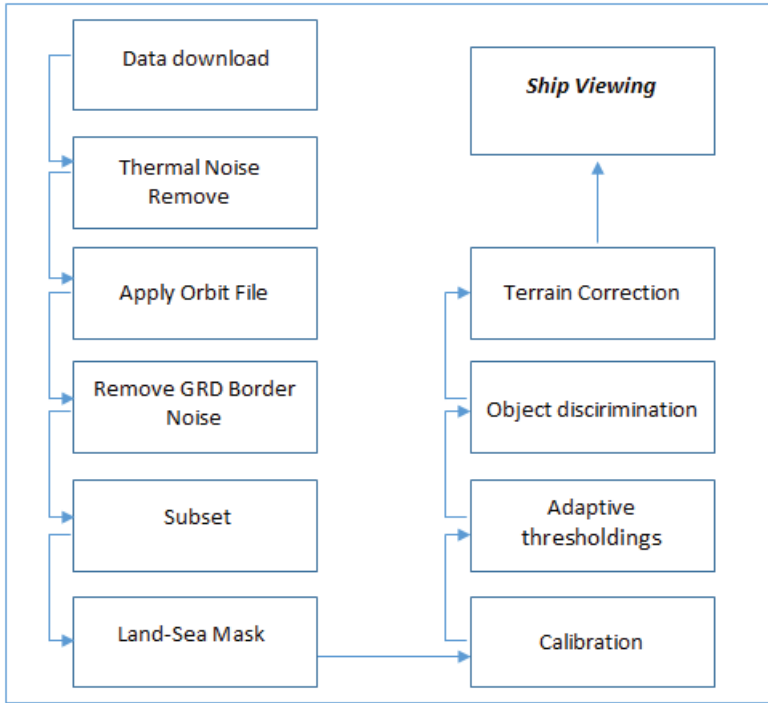

Figure-2 Satellite Based Ship Detection Algorithm

3-APPLICATION

For the application of ship detection using synthetic aperture satellite data, the data must first be obtained and then processed. Sentinel-1 Synthetic Aperture Radar data launched by the European Space Agency in 2014 was used in the applications (Table-1).

Table-1 Information of Sentinel-1 Satellite

Parameter	Sentinel-1
Start Date	3 June 2015
Wide Swath	250 km
Revisit time	6 days (with 1A and 1B)
Altitude	693 km
Inclination	98.18°

3.1 Sentinel-1 Data and Analysis

Sentinel-1 data is published in the standardized Sentinel Standard Archive Format for Europe (SAFE). Data is broadcast to users in Strip Map (SM), Interferometric Wide Swath (IW), and Extra Wide Swath (EW)

modes. Each mode consists of Level-0, Level-1 and Level-2 data (Figure-3). Level-0 refers to raw synthetic aperture radar data, Level-1 products refer to Single Look Complex (orbit and altitude information and geo-referenced data) and Ground Range Detected (data on which Earth Ellipsoid model is used and are presented as multi-look data), Level-2 refers to Ocean (OCN) products.

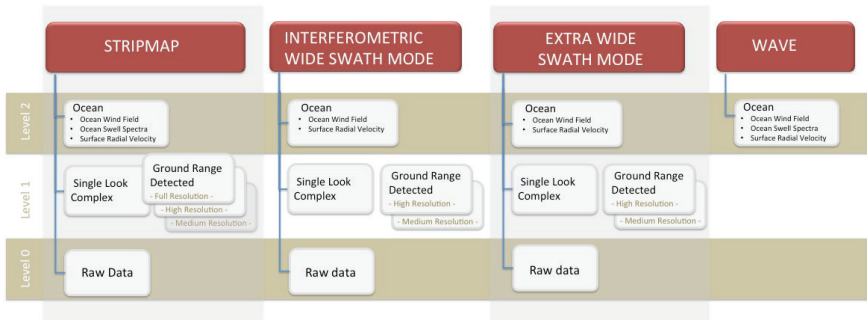

Figure-3 Sentinel-1 Core Products (URL2)

In order to detect ships using synthetic aperture radar, GRD products in IW mode are used in Sentinel-1 Artificial Aperture Radar images. For this, first the web address of Sentinel-Hub (<https://scihub.copernicus.eu/dhus/#/home>, accessed November, 2022) are visited and the steps shown in figure-4 are followed. These steps are as follows: login to the system (1), region selection (2), data selection based on characteristics (3) and selection of the image (4), respectively.

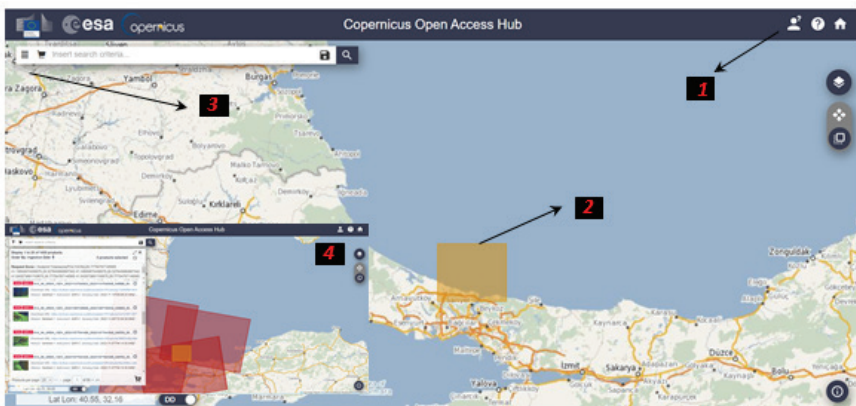

Figure-4 Sentinel-Hub Data download

In 2014, the European Space Agency made the Sentinel Applications Platform (SNAP) software available to users for the evaluation of Sentinel data. This software can be downloaded for free and can be developed by users. The latest version is SNAP 9.0 which was released to users on 29.06.2022 (<https://step.esa.int/main/download/snap-download/>, accessed December, 2022).

In this application, SNAP software provided by the European Space Agency was used and the steps in Figure 2 were followed. The use of SNAP software for ship detection using Sentinel-1 synthetic aperture radar images is shown step by step between Figure-5 and Figure-10. Following these processes, the visualization step was started. In this step, the data can be visualized using any geographic information systems software. QGIS, an open source software, is the recommended and the most frequently used software.

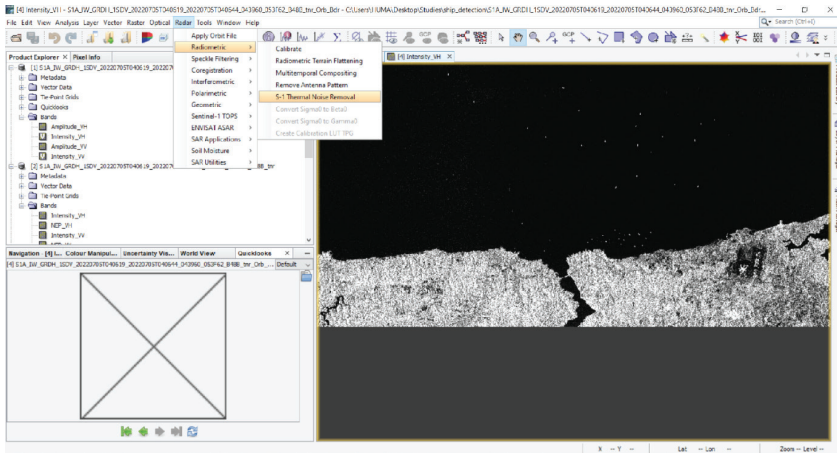

Figure-5 Thermal Noise Remove

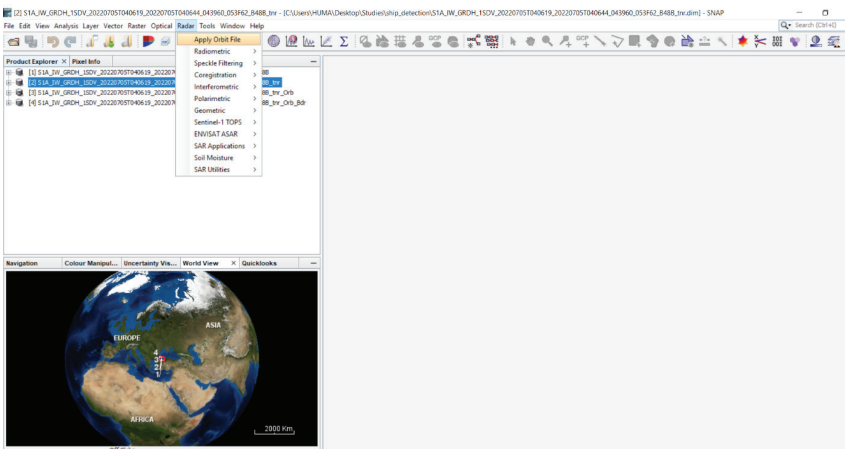

Figure-6 Apply Orbit File

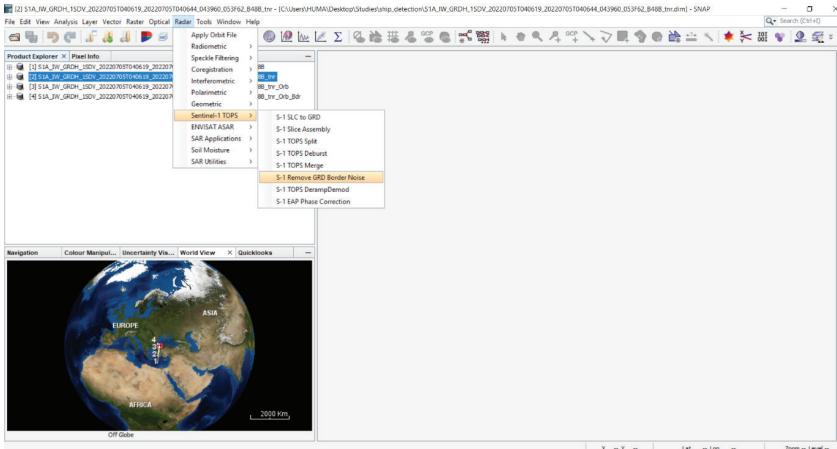

Figure -7 Remove GRD Border Noise

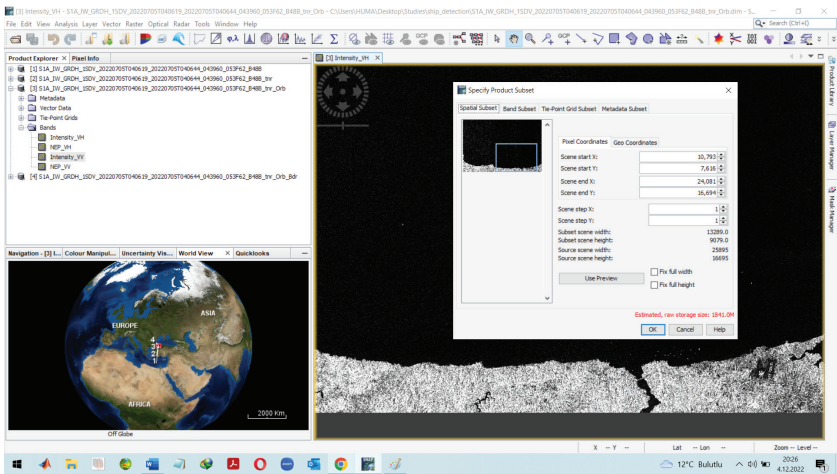

Figure -8 Subset

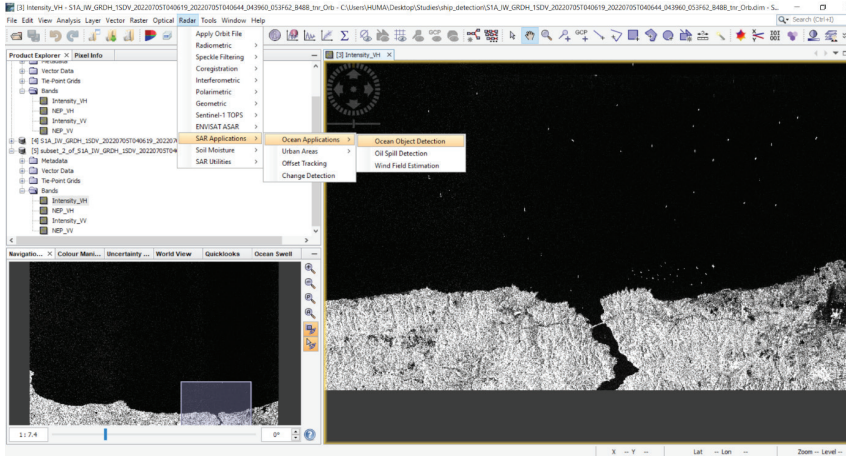

Figure -9 Land-Sea Mask, Calibration, Adaptive thresholdings, Object discrimination

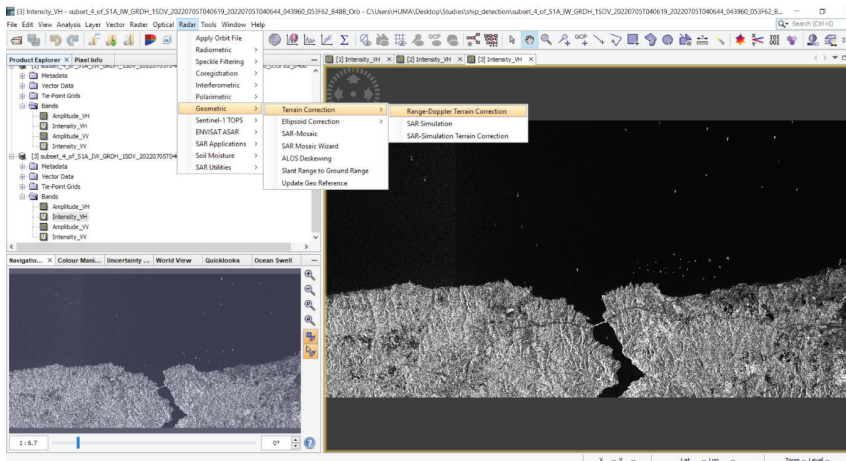

Figure -10 Terrain Correction

3.2 A Sample of Black Sea

In this study, the entrance to the Bosphorus Strait from the Black Sea was selected as the study area (Figure-11). The Bosphorus Strait is one of the routes having busy sea traffic. Since the traffic in the Bosphorus Strait is one-way for safety reasons, ships willing pass through the strait need to wait for a period of time which may sometimes last up to a week.



Figure-11 Study Area

Information about the data used in this application is shown in Table-2.

Table-2 Information of Data

Satellite	Date	File Type	Mode	Polarization	Relative Orbit	Cycle
Sentinel-1	5 July 2022	GRD	IW	VV-VH	138	265

After the data were obtained, the data were evaluated using the SNAP software. Accordingly, the steps in Figure-2 were followed and the modules between Figure-5 and Figure-10 were applied, respectively. Figure 12 shows the raw version of the data in Table-2 opened with SNAP software. Figure-13 shows the Subset and Apply orbit file of the raw image. Figure-14 shows the ships detected by applying all the steps using the satellite image. With the applied limitations, it was requested to detect ships with a length of 30 to 600 meters. Based on these limit values applied in the program, 133 ships, of which the shortest one was 30 m and the longest one was 290 m, were identified.

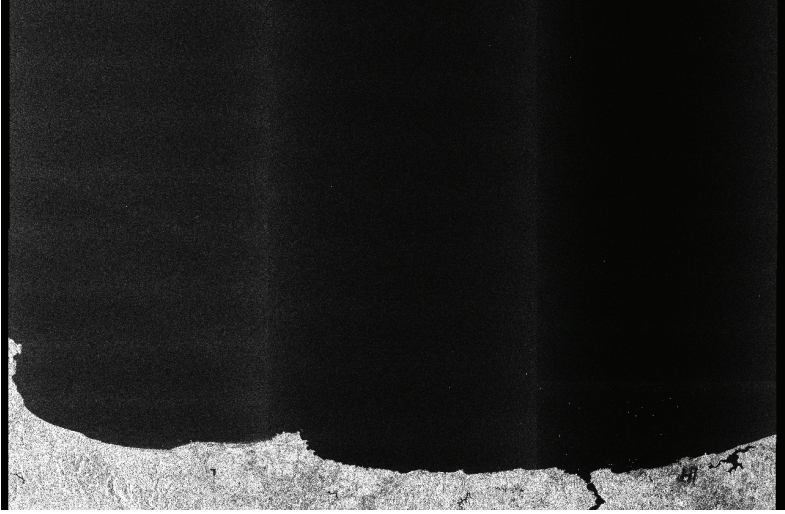

Figure-12 Raw GRD Images

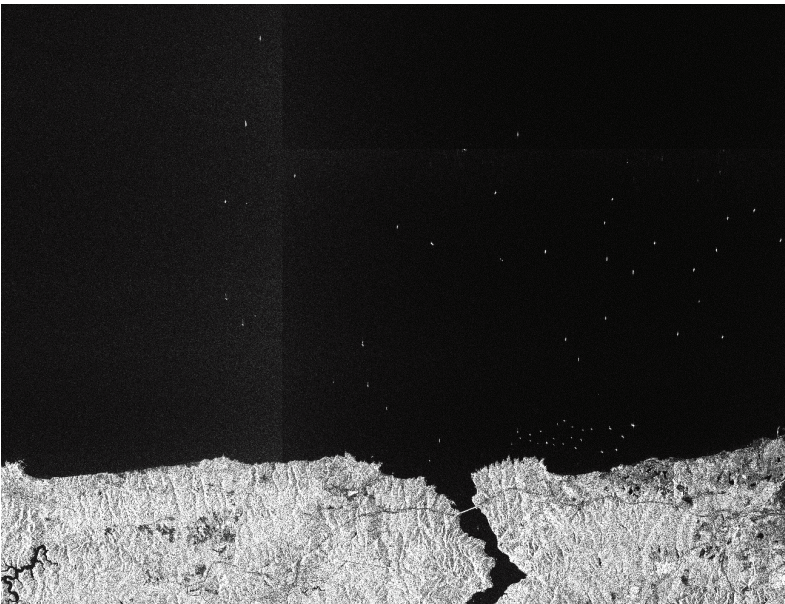

Figure -13 Subset and Corrected Images

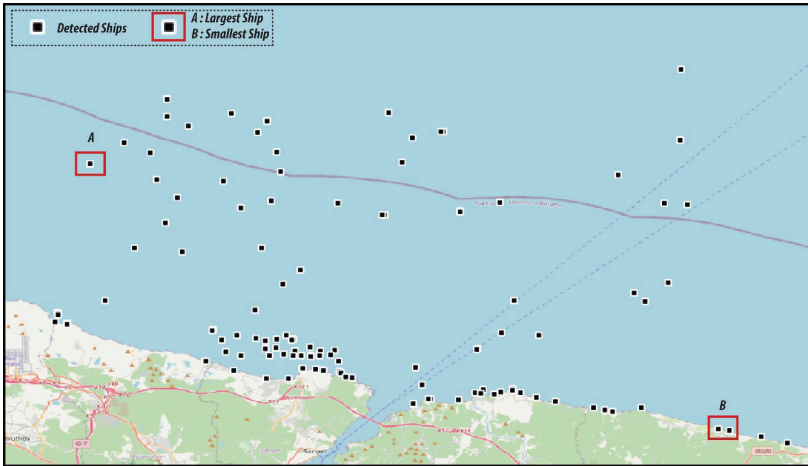

Figure -14 Detected Ships Mapping

4- CONCLUSIONS AND RECOMMENDATIONS

Ships are used in many activities such as fishing, passenger and cargo transportation, drilling operations, exploration and scientific research. Monitoring a ship along its route is also important in terms of security. The security issues include the management of ship traffic. There are some electronic devices on the ships for monitoring the ships. In addition, coastal countries may also use satellite data for a possible analysis. Sentinel-1 synthetic aperture radar images have been offered to users free of charge by the European Space Agency since 2014. In addition, Sentinel-1 synthetic aperture radar images can be evaluated using the open source/free SNAP software developed by the European Space Agency. The aim of this study was to detect ships using Sentinel-1 Synthetic Aperture Radar images. Hence, a procedure was developed by following the steps from acquiring data to detecting ships from images. It was aimed to make an application using the SNAP software and the Black Sea part of the Bosphorus Strait, which has the heaviest maritime traffic in the world, was selected as the study area. In the analyzes, the ships were detected using the Sentinel-1 synthetic aperture radar image of 05.07.2022. A total of 133 ships with a length of 30-290 meters (the entered threshold value was 30-600 m) were detected in the area where the image was taken. This study revealed that that ships can be detected in the anticipated region in accordance with the temporal resolution. It is recommended as a result of this study that ships can be detected outside the study area of this study, image-based regions of ships with a route away from 5-6 days can be determined, and the analyzes in this study can be used by relevant institutions and organizations.

REFERENCES

- Belenguer-Plomer M.A., Tanase M.A., Fernandez-Carrillo A., Chuvieco E. (2019). Burned area detection and mapping using sentinel-1 backscatter coefficient and thermal anomalies. *Remote Sensing of Environment*, 233, DOI:10.1016/j.rse.2019.111345
- Crisp, D. (2004). The State-of-Art in Ship Detection in Synthetic Aperture Radar Imagery. DSTO Information Science Laboratory, Edinburg.
- ESA INSARAP project, (2014). Mexico City subsidence, (http://www.esa.int/spaceinimages/Images/2014/12/Mexico_City_subsidence)
- Erkoç M.H, Doğan, U., Yildiz, H., Sezen, E. (2022). Estimation of vertical land motion along the south and west coast of Turkey from multi-sensor observations. *Advances in Space Research*, 70 (7), pp. 1761-1772, DOI:10.1016/j.asr.2022.06.022.
- Iervolino, P., Guida, R., Whittaker, P. (2015). A novel ship-detection technique for Sentinel-1 SAR data, *2015 IEEE 5th Asia-Pacific Conference on Synthetic Aperture Radar (APSAR)*, pp. 797-801, DOI 10.1109/AP-SAR.2015.7306324.
- Iervolino, P. (2016), Ship detection with SAR:modelling, designing and realdata validation, PhD thesis, University of Surrey
- Liu, C., Chen, Z., Shao, Y., Chen, J., Tuya, H., Pan, H. (2019). Research advances of SAR remote sensing for agriculture applications: A review. *Journal of Integrative Agriculture*, 18 (3): 506–525, DOI:10.1016/S2095-3119(18)62016-7.
- Nagai H., Abe, T., Ohki, M. (2021). SAR-Based Flood Monitoring for Flatland with Frequently Fluctuating Water Surfaces: Proposal for the Normalized Backscatter Amplitude Difference Index (NoBADI), *Remote Sensing*, 13(20), 4136; DOI:10.3390/rs13204136
- URL1, (22.11.2022), Microwave Remote Sensing, CRISP website, <https://crisp.nus.edu.sg/~research/tutorial/mw.htm>, accessed in November, 2022.,
- URL2, (23.11.2022), Data Products, Sentinel Online website, <https://sentinels.copernicus.eu/web/sentinel/missions/sentinel-1/data-products>, accessed in November, 2022.
- Xing, X., Chen, Z. L., Zou, H., and Zhou, S. (2009). A fast algorithm based on two-stage CFAR for detecting ships in SAR images. In Synthetic Aperture Radar, 2009. APSAR 2009. 2nd Asian-Pacific Conference
- Zhou, K., Zhang, M., Wang, H., Tan, J. (2022). Ship Detection in SAR Images Based on Multi-Scale Feature Extraction and Adaptive Feature Fusion. *Remote Sensing* 14, 755, DOI:10.3390/rs14030755

“

Chapter 6

**DISCRIMINATING OF ESSENTIAL
TREMOR AND PARKINSON’S DISEASE
USING FREQUENCY ANALYSIS
METHOD**

Negin MELEK¹

”

¹ *Department of Computer Engineering Giresun University Giresun,
Turkey 0000-0001-5297-5545*

I. Introduction

Tremors caused by competitive contraction of the muscles in the joints can occur anywhere in the human body and at any time [1]. In the medical world, tremor can be defined by four different features. These can be categorized as the affected area, related movement, frequency, and amplitude. Regionally, any part of the body such as the head, chin, elbow, or vocal cords can be affected by tremors. In terms of related movement, tremor can be divided into three basic classes: resting, postural, and kinetic tremors [2]. The resting tremor is a tremor that appears without involuntary movement, muscle contraction, or the effect of gravity [3]. Postural tremor is a type of tremor that occurs when an individual voluntarily resists gravity. Finally, kinetic tremor, which is seen with voluntary muscle movements, is very important in terms of early diagnosis, since it has the most negative impact on normal behaviors in life [4], [5]. The frequency is defined as less than 4 Hz, between 4-7 Hz, and greater than 7 Hz as low, medium, and high, respectively [1], [6]. Tremor disease shows variable amplitude depending on the level of stress, movement, and the development of the disease [7].

Since the frequency of movements of an individual living a normal life is lower than that of an individual with ET, frequency difference-based disease diagnosis is of great interest [8].

Among the different types of tremors, ET and PD are seen frequently in people between the ages of 60-65, and although they are not life-threatening, they negatively affect all aspects of human life [9] as well as the psychological aspect of the individual in the community [10]. In this case, tremor analysis is of great importance in order to fulfill the basic needs of the individual in her daily life and to improve her living standards [11]. Rapid and effective early diagnosis is difficult due to the similarity of symptoms and types of ET and PD [12]. In this context, the frequency and amplitude characteristics, which represent the basic features of the tremors, provide the ease of performing the classification process. The frequency parameter is a feature that has a great share in differentiating tremor types. On the other hand, the amplitude is generally used to follow the progression of the disease [13], [14].

ET, which is the most common type of tremor in the community, starts asymmetrically and spreads over time. This type of tremor usually increases in active positions and disappears at rest [15]. ET, which has a high frequency, sometimes manifests itself at rest, although it is rare and also is most common in the hands and arms [16], it is often benign and progresses slowly, not deeply restricting the individual's lifespan.

Parkinson's disease (PD), which creates high brain activity as a result of the gradual destruction of nerve cells of the human brain, is seen with a

frequency of 1% in individuals over 65 years of age [17]. Causes of contracting PD can be different factors such as genetic problems, exposure to toxins, gender, or age [18]. As the opposite definition of essential tremor, PT is actually a typical resting tremor. In short, this type of tremor decreases or even disappears in voluntary movements [19]. As the disease progresses in patients with ET, the amplitudes of the accelerometer signals increase while their frequencies begin to decrease. This change manifests itself differently in PD. In other words, while the amplitude decreases in patients with PD, the tremor may disappear completely.

Although the root cause of tremors is not clearly explained, it can sometimes be caused by thyroid problems as well as genetic mutations. Before making a clear diagnosis in patients with suspected ET, the possibility of using substances such as alcohol and nicotine, which cause habituation, is taken into account [18]. Based on the medical and scientific research, it is known that there is no definitive treatment for ET, and tremor scoring is done in the relevant clinics using tremor-based scales [20], [21]. The major disadvantage of clinical tremor scoring studies is the need for the presence of a clinician. In this case, there is a great difference of opinion in such studies. In addition to the necessity of a laboratory environment, long-term monitoring is not provided in these systems. Because it does not allow the tracking of tremor signals in the environment where the individual lives during the day.

Detection of patients with ET and PD is possible on the basis of the frequency difference they show [8], [2]. Considering the disadvantages of tremor test studies in clinics, comprehensive diagnostic studies based on artificial intelligence and machine learning algorithms can be performed [22], [23]. Thanks to the combination of frequency-amplitude analysis and machine learning methods, it is possible to classify patients with tremor [24], [25].

Early analysis and detection of tremors are of great importance in order to evaluate the patient's situation and improve his daily life. In order to fulfill this purpose, machine learning models based on artificial intelligence have been developed in many studies. A study in this area focused on the design of an automatic tremor classification model using machine learning algorithms, based on clinical tremor disease scoring results [25]. Another study used deep brain stimulation for a detailed examination of Parkinson's disease. This analysis improved the closed-loop control model of PD using parameter estimation [26]. In a small-scale clinical study, normal and pathological movement analysis research of healthy and PD patients was performed by Kotsavasiloglou et al. The designed model is shown to be a successful candidate to differentiate between diseased and healthy individuals [27]. In order to prevent misdiagnoses, a machine learning model

was designed considering the measurement of cortical thickness due to the changes in the brain pattern of patients with ET. Thanks to the dominant features obtained by focusing on the behavior of the brain lobes, it has been possible to identify individuals at risk as well as different subgroups of diseases with ET [28].

As a branch of machine learning, some studies have been carried out on the diagnosis of tremors using deep learning algorithms, which has recently attracted the attention of researchers [29]. In a study conducted with deep learning, a new model was developed for the measurement of PD tremors using a deep neural network algorithm as well as an effective pre-processing method by concentrating on tremor spectra [4]. As a result of the use of smartphones for tremor detection, PD tremor diagnosis was performed by proposing a multi-sample learning approach model in a study conducted in nature [30]. In another study [31], the discrimination of PD and ET accelerometer signals was performed using statistical signal processing methods.

Considering the above-mentioned studies, it seems that in the technological age, artificial intelligence-based machine learning methods provide a high potential to distinguish between different types of tremors [32]. The present study developed a machine learning model for tremor classification in ET/PD, and healthy individuals. In the data set used, signal processing analysis was performed by taking into account the accelerometer signals of essential, Parkinson's disease, and healthy individuals. It is aimed to develop a high-performance machine learning model by applying different classification algorithms to the model designed using statistical features of an effective feature extraction method. On the other hand, in this study consisting of two healthy and tremor classes, a comparison study was provided by using different classification algorithms. The goal of the study is to present a model that provides a high-performance classification technique as a result of the analysis of measurement signals taken from certain points of the arm.

II. Data Acquisition

A. Dataset

The database used in the study [18] includes arm tremors obtained by accelerometers of individuals without tremor and also individuals with ET and PD. The database of 37 volunteers included two patients with essential tremor, eight patients with Parkinson's disease, and twenty-seven healthy individuals. In this two-class study, accelerometer signals from 4 different parts of the arm were recorded with a signal collecting device to create the classification model of tremor disease and healthy volunteers. The graphic showing these measuring points is presented in Fig. 1. To prepare effective features in a successful classification process, the accelerometer signal re-

ording device has been demonstrated in detail in the study by Skaramagkas et al [18].

This device, which has two Arduino boards, can be used to safely measure the peak frequencies of Parkinson's and essential tremor by providing the maximum sampling rate. In this device, 4 different registration points are named index (I), thumb (T), metacarpal (M), and forearm (F) respectively.

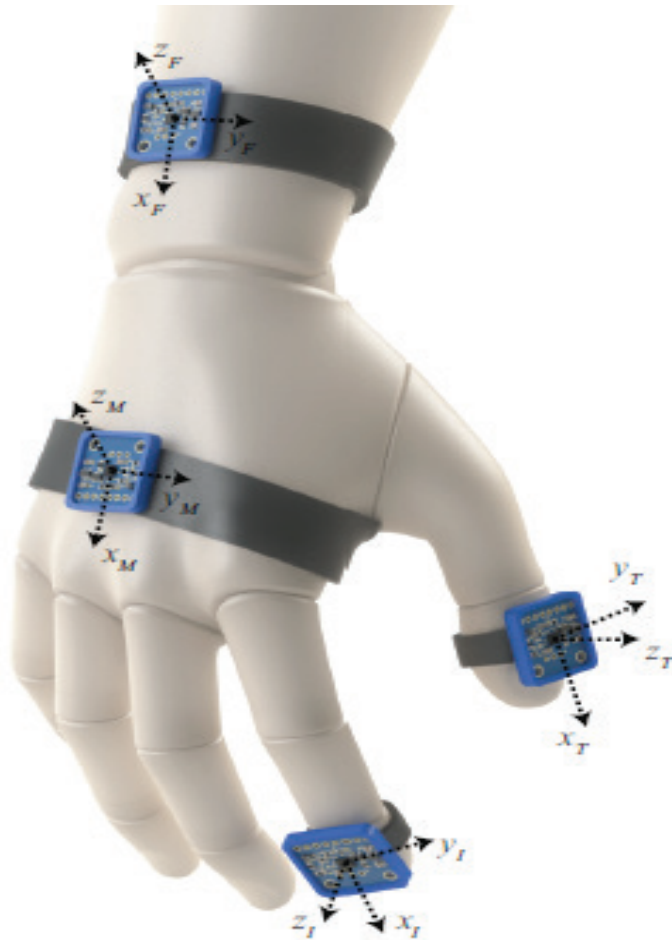

Fig. 1. Display of accelerometer signal recording points

During the measurement phase, the device connected to the hands of the volunteers was examined in four different situations. These were categorized as resting motion, extended position, freehand, and holding an object motion, respectively. Four types of hand gestures, including free hand

movement, putting the hand on the table, touching the nose, and oscillating, were explained to the volunteers in detail. Each measurement is set at 30 seconds. The wrong measurement was corrected and repeated. In our predicted machine learning model, the measurement time of 30 seconds is divided into two in terms of fast processing.

III. Methodology

The accelerometer marking identifying each measurement is shown with three different indices. These are designated i , j , and k . In this case, an accelerometer signal will be defined as $a_{i,j,k}$. The first index (i) represents arm positions. As described, four different arm situations were considered in this study. Four subsets representing each measurement were named index (I), thumb (T), metacarpal (M), and forearm (F), these denote j . The index k represents the accelerometer axis as $k=\{x,y,z\}$. Thus, the accelerometer signal of each volunteer individual is calculated as 48. In ET and PD diagnosis, the sampling frequency was chosen as 62.5 to ensure the safety of measuring peak frequencies. Approximately 1800 samples will be obtained for each recording with a length of 30 seconds.

A. Welch Feature Extraction Method

The spectrogram, which is the natural extension of the periodogram, is used for the time-frequency representation of random signals [33]. In the proposed study, the Welch method as a non-parametric approach was used for spectral power density analysis (PSD) [34]. In the Welch method, which is based on FFT, a windowing process is taken into account and each epoch is prepared for overlapping by dividing it into specific lengths. The window length was considered to be 2 seconds and the overlap was defined as window length-1 in this study. Then, the soft-behavior Hanning window was applied to each part and the periodogram was calculated. The PSD was obtained by averaging the periodograms obtained as the last step.

To prevent the under-sampling process, seven different statistical features between 0 and 32.25 Hz were prepared for each epoch to balance the sampling frequency value and the Nyquist criterion. If the signal is assumed to be x , these statistical functions were chosen as $\text{mean}(x)$, $\text{variance}(x)$, $\text{skewness}(x)$, $\text{kurtosis}(x)$, $\text{weighted entropy}(x)$, $\text{mean}(x^2)$, and $\text{RMS}(x)$ [35].

B. Classification Algorithms

The k -NN algorithm [36], which is one of the easy and supervised classifiers used in different regression and classification studies, shows successful performance in many machine learning studies by assigning a test sample to the class where the k -nearest training samples are the majority. In this classification method, the parameter k is chosen by the user

as a fixed value. In the classification phase, the classification process is performed by assigning the most common label from the k training samples closest to the test point. This algorithm is one of the easy-to-apply supervised learning algorithms. Although it is used in solving both classification and regression problems, it is mostly used in solving classification problems in the industry. With k -NN, basically the closest points to the new point are searched. k represents the number of nearest neighbors of the unknown point. We choose k quantities of the algorithm (usually an odd number) to predict the results. The role of the k parameter in this classifier is of great importance in terms of classification performance. Choosing $k=1$ or calculating k as a result of the cross-validation method has led to many studies.

In order to perform data analysis in a multidimensional space, the linear support vector machine (SVM) algorithm is generalized into a nonlinear algorithm by using the nonlinear operator [37]. One of the most important features of the SVM classification is the formation of a learning model from small-scale data sets. The SVM classifier, which is generally known for its good accuracy rate, shows an acceptable performance in terms of speed. By presenting a subset of the training data, it is chosen as the favorite classification algorithm of many studies, using less memory in the decision phase. The main framework of the SVM classifier, which performs well in high-dimensional spaces, is to classify data by creating a straight line or hyperplane. There are many kinds of kernels available to move into this multidimensional space known as the “kernel trick”. In our study, the SVM algorithm [38], one of the classification algorithms, was used with the Radial basis function (RBF) kernel [39].

The third classification algorithm used in the study is the Ensemble RusBoost algorithm [40]. This algorithm solves the unbalanced class problem by eliminating the random under sampling problem as much as possible at each refresh stage.

IV. Results and Discussion

After obtaining the effective features, the features of the data were introduced to a total of three different classification algorithms. These algorithms and their optimum parameter selections were presented in Table I.

Table I. Selected classification algorithms and their parameters

Classification Algorithms	Related parameters
k-NN	$k=1$
RBF SVM	$\text{Sigma}=1$
Ensemble RusBoost	Maximum number of splits=20

In the classification study, ET/PD and healthy individual classification were taken into account for four accelerometer positions (I, T, M, and F) in the x, y, and z axes, concentrating only on the resting phase of the arm poses. The results of Kappa, accuracy, ET/PD sensitivity, and healthy sensitivity parameters for the three different classifications are presented in Tables II, III, and IV for the x, y, and z axes, respectively.

Table II. Resting classification results for x axis

x axis	Classifier	Kappa	Accuracy	ET/PD Sensitivity	Healthy Sensitivity
	k-NN	0.617121	0.851351	0.7	0.907407
Index	SVM	0.544233	0.851351	0.45	1
	RusBoost	0.333047	0.716216	0.6	0.759259
	k-NN	0.338664	0.743243	0.5	0.833333
Thumb	SVM	0.239726	0.756757	0.25	0.944444
	RusBoost	0.309813	0.689189	0.65	0.703704
	k-NN	0.587124	0.824324	0.8	0.833333
Metacarpal	SVM	0.239726	0.756757	0.25	0.944444
	RusBoost	0.311337	0.702703	0.6	0.740741
	k-NN	0.74216	0.891892	0.9	0.888889
Forearm	SVM	0.576483	0.851351	0.55	0.962963
	RusBoost	0.499154	0.783784	0.75	0.796296

Table III. Resting classification results for y axis

y axis	Classifier	Kappa	Accuracy	ET/PD Sensitivity	Healthy Sensitivity
	k-NN	0.825964	0.932432	0.85	0.962963
Index	SVM	0.267327	0.783784	0.2	1
	RusBoost	0.574713	0.824324	0.75	0.851852
	k-NN	0.60447	0.851351	0.65	0.925926
Thumb	SVM	0.239726	0.756757	0.25	0.944444
	RusBoost	0.475396	0.77027	0.75	0.777778
	k-NN	0.617121	0.851351	0.7	0.907407
Metacarpal	SVM	0.3539	0.797297	0.3	0.981481
	RusBoost	0.475396	0.77027	0.75	0.777778
	k-NN	0.836428	0.932432	0.95	0.925926
Forearm	SVM	0.408676	0.810811	0.35	0.981481
	RusBoost	0.624365	0.837838	0.85	0.833333

Table IV. Resting classification results for z axis

z axis	Classifier	Kappa	Accuracy	ET/PD Sensitivity	Healthy Sensitivity
	k-NN	0.52037	0.810811	0.65	0.87037
Index	SVM	0.267327	0.783784	0.2	1
	RusBoost	0.413678	0.743243	0.7	0.759259
	k-NN	0.575526	0.837838	0.65	0.907407
Thumb	SVM	0.084158	0.72973	0.1	0.962963
	RusBoost	0.429846	0.743243	0.75	0.740741
	k-NN	0.290941	0.702703	0.55	0.759259
Metacarpal	SVM	-0.05168	0.702703	0	0.962963
	RusBoost	0.148026	0.621622	0.5	0.666667
	k-NN	0.378426	0.743243	0.6	0.796296
Forearm	SVM	0.267327	0.783784	0.2	1
	RusBoost	0.289008	0.662162	0.7	0.648148

Looking at the results, in the classification study of healthy individuals with ET/PD in the y-axis table, the k-NN classifier outperforms other classifiers with a 93% success rate in I and F cases. When focusing on the classification accuracy column, the successful discrimination of the process in the classification of ET/PD and healthy individuals in general in all three classification algorithms cannot be overlooked.

Rhythmic and involuntary tremors are oscillating movements that affect different parts of our body such as hands, eyes, and legs. Analysis of the characteristics of essential tremor (ET) and Parkinson's disease (PD), which are among the most common types of tremor syndrome, play an important role in the diagnosis of movement disorders worldwide. In addition, the frequency of tremors and the location of the affected area are among the parameters to be considered in the classification of tremor types. The similarity of symptoms between ET and PD has made early-stage diagnosis very difficult and complex. A clinical trial aimed at overcoming this challenge is discussed in the related paper. The arm tremor patterns and characteristics of the volunteers diagnosed with ET and PD were measured with a wearable device. In this study, which consists of the analysis of two classes, the classification of healthy individuals against ET or PD tremor is the main objective of the study. Effective features were extracted from the accelerometer signals obtained in the data set consisting of 37 individuals, and the basis for a successful classification was laid. Choosing the Welch feature extraction method, effective features were classified with three different classification algorithms. As a result of the use of Welch feature extraction and k-nearest neighbors (k-NN) algorithm in the classification study of tremor diseased and healthy individuals, 93% success was achieved.

V. Conclusion

A basic machine learning study was conducted to distinguish between ET/PD and healthy individuals. Since these tremor types have similar characteristics, an advanced model design is of great importance in terms of accurate diagnosis. The basis of the proposed classification model development study was laid by considering the data of a clinical test in which accelerometer signals of volunteers were obtained by setting measurement points from different arm poses. Statistical features were extracted from the received signals using the Welch method, and a step was taken for the classification process. In this clinical test consisting of four different postures, the resting phase was targeted for machine learning model design. Successful accuracy rates were obtained by using k-NN, SVM, and Ensemble RusBoost algorithms in the classification of healthy individuals with ET/PD at the hand resting stage.

Considering the general results of this basic study, it is predicted that the proposed machine learning model will give promising results for future studies. Future goals include early detection of ET/PD stages, and easy, portable, and wearable device design. In addition, thanks to accurate diagnoses, efficient and personalized treatment methods can be developed. In addition to increasing the number of volunteers, different feature extraction methods and classification algorithms can be focused on as machine learning steps.

References

- [1] Koller WC, Huber SJ. Tremor disorders of aging: Diagnosis and management. *Geriatrics*. 44(5): 33–41 (1989).
- [2] Elble RJ, McNamers J. Using Portable Transducers to Measure Tremor Severity. *Tremor Other Hyperkinet Mov (N Y)*. 6 (2016).
- [3] Bötzel K, Tronnier V, Gasser T. Differenzialdiagnose und therapie des tremors. *Dtsch Arztebl Int*. 111(13): 225–235 (2014).
- [4] San-Segundo R, Zhang A, Cebulla A, Panev S, Tabor G, Stebbins K, *et al*. Parkinson's Disease Tremor Detection in the Wild Using Wearable Accelerometers. *Sensors* 2020, Vol 20, Page 5817. 20(20): 5817 (2020).
- [5] Baumann CR. Epidemiology, diagnosis and differential diagnosis in Parkinson's disease tremor. *Parkinsonism Relat Disord*. 18 Suppl 1(SUPPL. 1) (2012).
- [6] Thanvi B, Lo N, Robinson T. Essential tremor—the most common movement disorder in older people. *Age Ageing*. 35(4): 344–349 (2006).
- [7] Findley LJ. Classification of tremors. *J Clin Neurophysiol*. 13(2): 122–132 (1996).
- [8] Rigas G, Tzallas AT, Tsiouras MG, Bougia P, Tripoliti EE, Baga D, *et al*. Assessment of tremor activity in the Parkinson's disease using a set of wearable sensors. *IEEE Trans Inf Technol Biomed*. 16(3): 478–487 (2012).
- [9] Elias WJ, Shah BB. Definitions of Tremor—Reply. *JAMA*. 312(2): 191–192 (2014).
- [10] Louis ED, Ferreira JJ. How common is the most common adult movement disorder? Update on the worldwide prevalence of essential tremor. *Mov Disord*. 25(5): 534–541 (2010).
- [11] Heldman DA, Jankovic J, Vaillancourt DE, Prodoehl J, Elble RJ, Giuffrida JP. Essential Tremor Quantification During Activities of Daily Living. *Parkinsonism Relat Disord*. 17(7): 537 (2011).
- [12] McAuley JH, Marsden CD. Physiological and pathological tremors and rhythmic central motor control. *Brain*. 123 (Pt 8)(8): 1545–1567 (2000).
- [13] Jankovic J, Schwartz KS, Ondo W. Re-emergent tremor of Parkinson's disease. *J Neurol Neurosurg Psychiatry*. 67(5): 646–650 (1999).
- [14] Wile DJ, Ranawaya R, Kiss ZHT. Smart watch accelerometry for analysis and diagnosis of tremor. *J Neurosci Methods*. 230: 1–4 (2014).
- [15] Cohen O, Pullman S, Jurewicz E, Watner D, Louis ED. Rest tremor in patients with essential tremor: prevalence, clinical correlates, and electrophysiologic characteristics. *Arch Neurol*. 60(3): 405–410 (2003).
- [16] Essential Tremor Disorder | Johns Hopkins Medicine, Available from: <https://www.hopkinsmedicine.org/health/conditions-and-diseases/essential-tremor-disorder>.

- [17] Goetz CG. The History of Parkinson's Disease: Early Clinical Descriptions and Neurological Therapies. *Cold Spring Harb Perspect Med.* 1(1) (2011).
- [18] Skaramagkas V, Andrikopoulos G, Kefalopoulou Z, Polychronopoulos P. A Study on the Essential and Parkinson's Arm Tremor Classification. *Signals* 2021, Vol 2, Pages 201-224. 2(2): 201–224 (2021).
- [19] Deuschl G, Bain P, Brin M, Agid Y, Benabid L, Benecke R, *et al.* Consensus statement of the Movement Disorder Society on Tremor. Ad Hoc Scientific Committee. *Mov Disord.* 13 Suppl 3(SUPPL. 3): 2–23 (1998).
- [20] Jankovic J. Parkinson's disease: clinical features and diagnosis. *J Neurol Neurosurg Psychiatry.* 79(4): 368–376 (2008).
- [21] Swartling C. The Essential Tremor Rating Assessment Scale. *J Neurol Neuromedicine.* 1(4): 34–38 (2016).
- [22] Daneault JF, Carignan B, Codère CÉ, Sadikot AF, Duval C. Using a smart phone as a standalone platform for detection and monitoring of pathological tremors. *Front Hum Neurosci.* 6(DEC): 1–31 (2013).
- [23] Senova S, Querlioz D, Thiriez C, Jedynak P, Jarraya B, Palfi S. Using the Accelerometers Integrated in Smartphones to Evaluate Essential Tremor. *Stereotact Funct Neurosurg.* 93(2): 94–101 (2015).
- [24] Suppa A, Asci F, Saggio G, Di Leo P, Zarezadeh Z, Ferrazzano G, *et al.* Voice Analysis with Machine Learning: One Step Closer to an Objective Diagnosis of Essential Tremor. *Mov Disord.* 36(6): 1401–1410 (2021).
- [25] Jeon H, Lee W, Park H, Lee HJ, Kim SK, Kim HB, *et al.* High-accuracy automatic classification of Parkinsonian tremor severity using machine learning method. *Physiol Meas.* 38(11): 1980 (2017).
- [26] Liu C, Wang J, Deng B, Wei X, Yu H, Li H, *et al.* Closed-Loop Control of Tremor-Predominant Parkinsonian State Based on Parameter Estimation. *IEEE Trans Neural Syst Rehabil Eng.* 24(10): 1109–1121 (2016).
- [27] Kotsavasiloglou C, Kostikis N, Hristu-Varsakelis D, Arnaoutoglou M. Machine learning-based classification of simple drawing movements in Parkinson's disease. *Biomed Signal Process Control.* 31: 174–180 (2017).
- [28] Serrano JI, Romero JP, Castillo MD Del, Rocon E, Louis ED, Benito-León J. A data mining approach using cortical thickness for diagnosis and characterization of essential tremor. *Sci Reports* 2017 71. 7(1): 1–16 (2017).
- [29] Nweke H, Teh Y, Al-Garadi M, with UA-ES, 2018. Deep learning algorithms for human activity recognition using mobile and wearable sensor networks: State of the art and research challenges. *Elsevier.* 105: 233–261 (2018).
- [30] Papadopoulos A, Kyritsis K, Klingelhofer L, Bostanjopoulou S, Chaudhuri KR, Delopoulos A. Detecting Parkinsonian Tremor From IMU Data Collected in-the-Wild Using Deep Multiple-Instance Learning. *IEEE J Biomed Heal informatics.* 24(9) (2020).

- [31] Hossen A, Muthuraman M, Al-Hakim Z, Raethjen J, Deuschl G, Heute U. Discrimination of Parkinsonian tremor from essential tremor using statistical signal characterization of the spectrum of accelerometer signal. *Biomed Mater Eng.* 23(6): 513–531 (2013).
- [32] Ibrahim A, Zhou Y, Jenkins ME, Luisa Trejos A, Naish MD. The Design of a Parkinson's Tremor Predictor and Estimator Using a Hybrid Convolutional-Multilayer Perceptron Neural Network. *Proc Annu Int Conf IEEE Eng Med Biol Soc EMBS.* 2020-July: 5996–6000 (2020).
- [33] Anderson R, Sandsten M. Time-frequency feature extraction for classification of episodic memory. *EURASIP J Adv Signal Process.* 2020(1): 1–18 (2020).
- [34] Melek M, Manshour N, Kayikcioglu T. Low-Cost Brain-Computer Interface Using the Emotiv Epoc Headset Based on Rotating Vanes. *Trait du Signal.* 37(5): 831–837 (2020).
- [35] Melek M, Manshour N, Kayikcioglu T, M M, N M, T K, *et al.* An automatic EEG-based sleep staging system with introducing NAOsP and NAOsGP as new metrics for sleep staging systems. *Cogn Neurodyn.* 15(3): 405–423 (2021).
- [36] Melek M. Diagnosis of COVID-19 and non-COVID-19 patients by classifying only a single cough sound. *Neural Comput Appl* 2021. 1–12 (2021).
- [37] Viitaniemi V, Sjöberg M, Koskela M, Ishikawa S, Laaksonen J. Advances in visual concept detection: Ten years of TRECVID. In *Advances in Independent Component Analysis and Learning Machines.* Elsevier pp. 249–278 (2015).
- [38] Makalesi A, Üniversitesi G, Yüksekokulu GM, Ve E, Bölümü O. Solunum Hastalıkları ile İlişkili Semptom Seslerinin Sınıflandırılması. *Avrupa Bilim ve Teknol Derg.* 28(28): 333–337 (2021).
- [39] Melek Manshour N. Identifying COVID-19 by using spectral analysis of cough recordings: a distinctive classification study. *Cogn Neurodynamics* 2021. 1–15 (2021).
- [40] Mounce SR, Ellis K, Edwards JM, Speight VL, Jakomis N, Boxall JB. Ensemble Decision Tree Models Using RUSBoost for Estimating Risk of Iron Failure in Drinking Water Distribution Systems. *Water Resour Manag.* 31(5): 1575–1589 (2017).

“

Chapter 7

BLOOD GLUCOSE PREDICTION FROM NONDIABETIC AND DIABETIC EXHALED BREATH VIA MACHINE LEARNING

Taleh BINNATOV¹,

Tamila ANUTGAN²

Hakan YILMAZ³

”

1 Yüksek Lisans öğrencisi; Karabük Üniversitesi Mühendislik Fakültesi Biyomedikal Mühendisliği Bölümü. taleh.binnatov@gmail.com ORCID No: 0000-0001-8500-0808

2 Prof. Dr.; Karabük Üniversitesi Mühendislik Fakültesi Tıp Mühendisliği Bölümü. tamilaanutgan@karabuk.edu.tr ORCID No: 0000-0002-0287-265X

3 Dr. Öğr. Üyesi; Karabük Üniversitesi Mühendislik Fakültesi Tıp Mühendisliği Bölümü. hakanyilmaz@karabuk.edu.tr ORCID No: 0000-0002-8553-388X

Introduction

It is well known that when insulin, which enables the glucose in the blood to enter the cell and turn it into the energy, is not produced enough and/or the cells do not respond to insulin well, the blood glucose (BG) level rises. Such high BG characterizes a rapidly spreading chronic metabolic disease, Diabetes Mellitus (DM) (American Diabetes Association, 2014). According to the International Diabetes Federation Atlas 2019 data, the number of people with DM is predicted to reach 578 million by 2030 (Saeedi et al., 2019). The most important metabolic complications of DM caused by a severe hyperglycemic state are diabetic ketoacidosis (DKA) and/or hyperglycemic hyperosmolar syndromes. In addition, in the long term, DM may cause damage to the blood vessels in the retina (diabetic retinopathy), to the kidney at the microvascular level (nephropathy), DM may lead to the diabetic foot ulcer, the peripheral neuropathy (amputation and Charcot joint disease) and the autonomic neuropathy (damage in the cardiovascular, gastrointestinal, genitourinary and neurovascular systems). Also, people with DM exhibit more abnormalities of lipoprotein metabolism and hypertension (American Diabetes Association, 2014).

As proposed by the American Diabetes Association, it is still accepted to identify type 1 diabetes (T1D) and type 2 diabetes (T2D) as common classes of DM. While T1D occurs due to the destruction of β cells that secrete insulin in the pancreas, T2D occurs mainly due to the insulin resistance mostly caused by obesity (Kharroubi, 2015:850). In either case, glycemic control is important for DM management. Therefore, people with DM should monitor their BG levels several times (2-5) per day by self-monitoring the BG (SMBG) technique via home-based glucometer measurements (Kovatchev, 2012:1). The recommended number of measurements for T2D patients is at least 2 times a day (Abma, 2021), whereas for T1D is 6-10 times a day (American Diabetes Association, 2020:77). However, since a blood sample is taken from the finger during each BG level measurement, DM patients do not reach this recommended number of measurements in practice. Indeed, there are situations when T2D patients do not check their BG level even for months because of the invasiveness of this SMBG procedure.

To overcome the invasiveness problem of the home-based glucometer, different non-invasive BG level measurement techniques were proposed up to now and the promising one is to estimate BG level from the breath because the BG values are found to be related to the volatile organic compounds (VOCs) in the exhaled breath, specifically to the breath ethanol and acetone concentration (Galassetti et al., 2005:115). Since the breath ethanol concentration is much lower than the acetone one (Galassetti et al., 2005:115), BG is usually correlated solely with the acetone concentration

in the breath. This correlation is based on the fact that the rise of BG levels in DM patients starts when their body cannot use glucose as energy and as a response to this energy deficiency their liver burns fat as an alternative fuel source. During this fat-burning, ketone bodies are formed: acetone (C_3H_6O), acetoacetate (AcAc, $C_4H_6O_3$) and 3- β -hydroxybutyrate (3HB). Since acetone is more volatile than other ketones, it is present in the exhaled breath (Turner, 2011). Acetone smell in the breath is observed also for nondiabetic people (ND) who are fasting and/or exercising for a long time so that they experience fat burning process (Bovey et al., 2018:50). There are already commercially available non-invasive portable small-sized ketone breath analyzers replacing urine strips or blood ketone invasive devices (*Ketonix Clinic*, 2022),(*Keto Breath Monitor*, 2021). These ketone breath analyzers provide the users of a ketogenic diet with the level of their ketosis state, but it is a rough classification of the measured acetone concentration in the exhaled breath. On the other hand, for DM patients the research is based on the delicate correlation of the breath acetone (BA) concentration with the BG values, which is a much more complex problem. In addition, DM patients (mostly T1D) sometimes may experience very fast fat burning, which rises their BG level and at the same time ketones, so that the blood becomes acidic, i.e. DKA process (Dhatariya et al., 2020:40). As a result, during DKA, a strong acetone smell is developed in a breath with an acetone concentration even much higher than for the ND individuals undergoing starvation ketosis (*Keto Breath Monitor*, 2021). On the other hand, T2D patients during fasting, exercising, and/or ketogenic diet may experience fat burning just like an ND individual (Yuan et al., 2020:38), so the two different reasons behind their fat-burning can overlap leading to a more complex relationship between their exhaled acetone concentration and BG level.

Since the BA is on the order of parts per million (ppm), it is not easily detected accurately. Trotter et al. presented in 1971 the first quantitative detection of acetone from the exhaled breath using the gas chromatography (GC) technique and found a positive linear relationship between GC-measured BA and plasma acetone (standard chemical method) for 9 patients with DKA (Trotter et al., 1971:137). In addition to the GC method, various other techniques were used to measure the BA and determine its relationship to the BG: GC mass spectrometry (Galassetti et al., 2005:115), breath analyzer system based on Cavity Ring-Down Spectroscopy (CRDS) (Sun et al., 2017),(Gong, 2014), CMOS Microelectromechanical system based (MEMS) system (Rabih et al., 2018:9486), an electronic nose based on Quartz Crystal Microbalance (QCM) sensors system (Saraoglu et al., 2013:4229), Nuclear Magnetic Resonance (NMR) technique (Luaibi et al., 2015). Some of these studies reported no or weak relationship between BG

and BA (Sun et al., 2017),(Gong, 2014). In summary, some of these methods and systems are costly, difficult to handle, and difficult to use (GC), some require calibration procedure (CRDS), some can be easily degraded and have limited sensitivity (MEMS), some have costly multiprocess complex systems (QCM) (Lekha & M, 2021:127). On the other hand, it is more convenient to use metal oxide semiconductor (MOS) based gas sensors with high sensitivity, low cost, the simple measurement for the same purpose (Thati et al., 2015:1244; Guo et al., 2012:106; Lekha & M., 2018:1630; Yan & Zhang, 2012; Tayyab Hassan et al., 2018; Maillard et al., 1999:389). In one of these studies 12 MOS gas sensors were used to collect breath samples from 192 DM patients which were classified by the support vector ordinal regression (SVOR) method into 4 categories according to fasting BG levels: "well controlled", "slightly controlled", "poorly controlled" and "uncontrolled" (Guo et al., 2012:106). Unfortunately, the result showed that the classification accuracy was very low for the clinical application of this system (Guo et al., 2012:106). On the other hand, Yan et al. used the K-nearest neighbor (KNN) classification in 2 categories with a larger number of data (294 ND+294 DM) (Yan & Zhang, 2012). Half of this collected data (equal number of data for both categories) was used for the classification training, while the other half was used for testing (Yan & Zhang, 2012). As a result of the study, it was reported that the system can distinguish between ND and DM samples (Yan & Zhang, 2012). Another study proposed the use of a 1-dimensional (1D) modified convolutional neural network (CNN) algorithm that combines the feature extraction and classification techniques of breath signals to improve performance in DM classification (Lekha & M., 2018). Here, 15 data were used for training and 10 data for testing (Lekha & M., 2018:1630). It should be noted that in these classification studies BG values were not obtained after training, they only reported the ranges of BG levels. It is known that to reach a high accuracy, the training in the classification study must be done with a higher number of data. On the other hand, in the studies where the artificial neural network (ANN) (Thati et al., 2015) and regression classifier (Tayyab Hassan et al., 2018) were used the BG values were estimated with the error limits. Thati et al. measured the acetone concentration from the breaths of 30 volunteers with the MOS gas sensor and BG values with a glucometer: after training the BG was estimated with an error limit of ± 7.5 mg/dl (Thati et al., 2015:1244), however, the number of data was too low, especially to be trained on the ANN. In a recent promising study, 100 breath data were collected from 100 DM subjects: the linear regression classifier with only one feature was used for training this data, which resulted in a correlation score of 0.92 (Tayyab Hassan et al., 2018).

To sum up, when the previous studies on the relationship between the BG and BA values are considered, there is still no extensive work in the liter-

ature that considers both satiety status and diabetes class of the subjects. The main aim of this article is to reveal the correlation between BG and BA values more comprehensively by using the satiety status and DM class parameters during the data training. For this purpose, BG and BA measurements of T1D, T2D, and ND individuals were made separately in the satiety and fasting states. The saturation level and diabetic class were then included as parameters in the machine learning (ML) methods. For this 'BG - BA' correlation, the data were trained with different ML methods and their accuracies were compared. In addition, the use of the commercial MOS-based Grove Air Quality v1.3 sensor (AQS) for BA measurements was demonstrated in this study for the first time to the best of our knowledge.

Materials and Method

Volunteer Characteristics

To examine the correlation between the breath BG and BA values 37 volunteers were included in this study. Volunteers live in the Turkish province of Karabuk and have a wide range of age, height, and weight characteristics. Additionally, they are T1D, T2D, and ND (control group) subjects. These T2D subjects receive only 1 or 2 oral antidiabetic drugs per day, but do not receive any injections. On the other hand, the T1D subjects receive at least 2 insulin injections per day. The detailed characteristics of 37 people included in this study are provided in Table 1: 26 men, 11 women; 23-68 age range; 11 Normal Weight (NW), 15 Pre-Obese (PO), 8 Obese Class 1 (OC1), 2 Obese Class 2 (OC2), 1 Obese Class 3 (OC3); 26 ND, 7 T2D, 4 T1D. From 26 ND individuals 96 data: 35 preprandial, 61 postprandial; from 7 T2D subjects 33 data: 7 preprandial, 26 postprandial; from 4 T1D subjects 12 data: 5 preprandial, 7 postprandial were collected. As a result, the total number of collected data is 141. On the other hand, a wide range of age and BMI is used in this study with the statistics summarized in Table 2. Also, Fig. 1a suggests that there is a weak second-degree correlation between the collected age and BMI data. Although the number of volunteers is small (37), BMI and age ranges are statistically sufficient, since the correlation curve in Fig. 1a is similar to the statistical correlation curve found before for very large populations (Jayne et al., 2019; Maillard et al., 1999; *Report of a WHO Consultation on Obesity*, 1997). The number of subjects versus BMI category for ND, T2D, and T1D subjects is provided in Fig. 1b. Here the ND subjects are found to have low BMI values, while T2D subjects possess high BMI values (PO and Obese) and T1D subjects' BMI is average PO. Even with such a low number of subjects at hand, the results of Fig. 1a are consistent with the previous extensive studies: 50% of individuals with T2D are obese and approximately 90% are PO (Garber, 2012), while 186 T1D patients were found to have higher BMI values than 15,771 ND individuals (Fellinger et al., 2019). In total, the

volunteers of this study exhibit a wide range of age, BMI, and DM classes that can be used for preliminary statistical examination.

Table 1: *The characteristics of the volunteers who participated in the study. (According to the World Health Organization (WHO), NW: 18.5-24.9 kg/m²; PO: 25.0-29.9 kg/m²; OC1: 30.0-34.9 kg/m²; OC2: 35.0-39.9 kg/m²; OC3: ≥40.0 kg/m² (Report of a WHO Consultation on Obesity, 1997))*

Subject	Gender	Age (years)	BMI (kg/m ²)	BMI Category	# of data	Total # of data
ND-1	M	23	21.9	NW	31	96
ND-2	M	27	22	NW	2	
ND-3	F	51	31.6	OC1	1	
ND-4	F	36	21.5	NW	17	
ND-5	M	37	23.5	NW	14	
ND-6	M	34	33.7	OC1	5	
ND-7	M	30	28.4	PO	3	
ND-8	F	33	21.1	NW	1	
ND-9	M	35	26.5	PO	2	
ND-10	M	50	32.1	OC1	1	
ND-11	F	27	27.3	PO	2	
ND-12	F	31	37.7	OC2	2	
ND-13	M	30	19.9	NW	1	
ND-14	M	34	32.9	OC1	1	
ND-15	M	41	27.1	PO	1	
ND-16	M	35	24.2	NW	1	
ND-17	M	52	27.8	PO	1	
ND-18	F	30	22.5	NW	1	
ND-19	M	60	26.1	PO	2	
ND-20	M	35	23.9	NW	1	
ND-21	F	38	27.1	PO	1	
ND-22	M	38	26.6	PO	1	
ND-23	M	36	31.5	OC1	1	
ND-24	M	50	27.7	PO	1	
ND-25	M	42	25.8	PO	1	
ND-26	M	25	23.4	NW	1	
T2D-1	F	41	36.6	OC2	10	33
T2D-2	F	67	33.8	OC1	13	
T2D-3	M	43	42.9	OC3	3	
T2D-4	F	48	29.4	PO	2	
T2D-5	M	41	28.4	PO	2	
T2D-6	F	67	30.5	OC1	1	
T2D-7	M	41	28.7	PO	2	
T1D-1	M	68	24.6	NW	9	12
T1D-2	M	56	30.4	OC1	1	
T1D-3	M	49	28.1	PO	1	
T1D-4	M	36	28.4	PO	1	

Table 2: Descriptive statistics of volunteers' age and BMI values.

N:37 (F:11 M:26)	Max	Min	Mean	Median	SD
Age	68.00	23.00	41.00	38.00	11.60
BMI	42.90	19.90	27.99	27.70	4.92

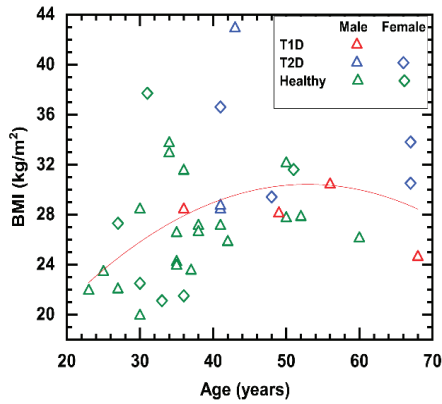

a)

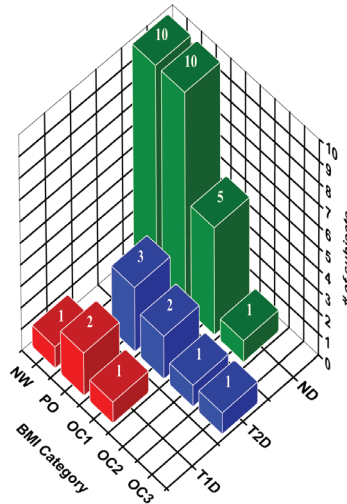

b)

Fig. 1: a) Correlation found between BMI and age, b) # of subjects versus BMI Category for ND, T2D and T1D subjects.

Gas Sensor Chamber

To collect BA data, all the volunteers were asked to blow into a 20x20x5 cm homemade chamber. This chamber contains AQS for measuring the concentration of acetone in the breath, 128X64 0.96 Inch OLED for displaying gas sensor values. The rechargeable battery for powering the circuit and Arduino Nano board for receiving and reading values from the sensor are attached to this chamber. There is a blowhole for blowing in the chamber with the use of a disposable mouthpiece, and a few holes for letting the breath go out of the chamber. The blowhole was positioned above AQS, which includes the MP503 sensor that is sensitive to VOCs such as acetone and alcohol. This sensitivity is due to the reactions occurring on the surface of the sensor. The sensor is composed of the heater and the MOS material on the ceramic substrate Al_2O_3 . Contact of gases with the surface of the MOS increases the conductivity of the sensor, so the change in the conductivity values is converted to the concentration of the target gas. For the case of the present study, when the acetone concentration increases in the environment of the AQS, its conductivity also increases. To calculate the sensor values in ppm, calculations were made according to the sensitivity curve of AQS and its analog value was converted to ppm (*Mp503 English.Pdf*, 2021). Like other MOS sensors, before measurements were conducted when first turned on, the AQS sensor was heated for at least 3 minutes (Tayyab Hassan et al., 2018) to stabilize itself. In the previous studies, the AQS sensor was used to measure air pollution, and air quality in real-time and to design the air quality sensor warning system (Biondi et al., 2019; Towakel et al., 2018; Maharjan, 2018; Musoro, 2019). However, this sensor was never used before for the measurement of the BA concentration, so the present work applied AQS for the BA detection for the first time.

Breath Data Acquisition

In this study the following conditions were satisfied during the breath measurements:

- all the subjects were in a normal breathing rhythm;
- all the subjects did not have lung/liver/kidney or similar diseases which may affect the amount of VOCs in the exhaled breath;
- all the subjects did not eat large amounts of fruit and other food which would cause a pungent odor (e.g. garlic) for at least 2 hours before blowing into the gas sensor chamber;
- all the subjects did not drink pungent drink (e.g. coffee) at least half an hour before blowing into the gas sensor chamber;

- all the subjects did not eat snacks like chewing gum, candy with menthol etc. and did not perform oral care (e.g. gargling, tooth brushing) at least 1 hour before blowing into the gas sensor chamber;
- all the subjects did not drink alcohol at least 24 hours before blowing into the gas sensor chamber;
- the smoker volunteers blew into the gas sensor chamber at least half an hour after smoking a cigarette (a large percentage of the subjects in this study were non-smokers);
- all the subjects were labeled to be ‘preprandial’ if they did not take meal for at least 3 hours and at most 5 hours before blowing into the gas sensor chamber (most of the subjects’ preprandial state was measured between their meal intakes, i.e. it is not the fasted state in the morning that is routinely followed in other studies);
- all the subjects were labeled to be ‘postprandial’ if they took meal around 2 hours before blowing into the gas sensor chamber;
- all the subjects blew into the gas sensor chamber using a disposable mouthpiece for an average of 1.5 seconds. 3 consecutive blows were collected from each subject during one breath measurement and the time between each blow was around 15 seconds. The average of these 3 values was recorded as the breath data for each measurement;

BG Level Acquisition

The BG level was self-measured by volunteers using the same invasive commercial glucometer device Bayer Contour TS BG monitor with the disposable lancets and test strips. All volunteers pricked their middle finger and after wiping away the first two blood drops they extracted the third drop on the Bayer Contour TS test strip. BG values were self-measured by volunteers immediately after their breath data were collected by the home-made gas sensor chamber.

ML Methods

As it is well known, ML is a branch of science that deals with extracting information from existing data, it is the intersection of statistics and computer science, and it is also a subfield of artificial intelligence. ML is also referred to predictive analytics or statistical learning. ML methods have become common in almost every field including daily life in recent years (Müller & Guido, 2016:371), and are frequently used in the health science. ML methods are classified according to the type of supervision they receive during training. The type of training in which causes and results are given to the system is called supervised learning (Géron, 2017:551). There are two major types of supervised learning: classification and regression.

The purpose of classification is to select a class from predefined probabilities. Regression, on the other hand, tries to estimate a continuous number (Müller & Guido, 2016:371). In this study, three methods belonging to the regression group of supervised learning types were used to estimate the amount of the glucose in the blood from the breath data. These methods are polynomial linear regression (PLR), multi-layer perceptron (MLP) and support vector regressor (SVR).

1. PLR

Linear regression is a widely used method for finding the relationship between linear data and making predictions according to this relationship. This method is advantageous as it is fast and simple. However, it gives poor performance when the data is nonlinear. One of the ways to overcome this problem is to add the powers of each feature as new features, and then train a linear model on this extended set of features. This technique is called PLR. Especially when multiple features are used for regression, the relationships can be found by adding combinations between features. This is a property that the linear regression model cannot do. For example, if an input is two-dimensional and has the form $[a, b]$, the degree-2 polynomial features are $[1, a, b, a^2, ab, b^2]$ (Géron, 2017:551). As for this study, degree-3 polynomial features were used.

2. MLP

Perceptron is one of the simplest neural network architectures in which a weighted z value is obtained using an addition function of inputs and weights and gives output as a result of applying an activation function to this z value (Géron, 2017:551). But this method has some limitations. It cannot produce solutions to nonlinear problems such as XOR problems. This can be overcome with MLP. MLP is a neural network model that produces output as a result of connecting multiple perceptrons as hidden layers (Fig. 2)(Müller & Guido, 2016:376).

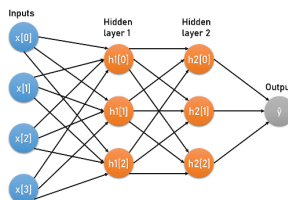

Fig. 2: A MLP with two hidden layers (Müller & Guido, 2016:376).

3. SVR

Support vector machines (SVM) are popular methods for classification and regression. SVM allows to divide the z space consisting of input vectors from the optimal location through hyperplanes. The goal here is to have the margins at the maximum value when they are drawn for creating hyperplanes (Vapnik, 2000). This principle gives quite good results for classification, but it is applied with some small differences for the regression because it is difficult to predict numbers with infinite probability. An approximate tolerance margin (epsilon) is added to eliminate this difficulty. In regression, as in classification, it is aimed to find hyperregulations that will maximise the margin. This is an optimisation problem and solving it is simpler with its Lagrange dual formulation. The approximate function that occurs after this approach is given in Equation 1 (Chang & Lin, 2011:1). This equation is used to estimate new values. $(-\alpha_i + \alpha_i^*)$ stores the difference between two Lagrange multipliers of support vectors, x_i stores support vectors and b stores bias.

$$\sum_{i=1}^l (-\alpha_i + \alpha_i^*)K(x_i, x) + b. \quad (1)$$

RESULTS AND DISCUSSION

Correlation between BG and BMI values

Before going into the details of the correlation between BG and BA, which is the main point of the present study, the dependence of the volunteers' glucometer-measured BG on their BMI data was examined (Fig. 3). The green symbols in Fig. 3 show that while the BMI range of ND people is low (between ~ 20 and ~ 38 kg/m²) their BG values are limited by 130 mg/dl. This maximum BG value is expected for the people without DM as their upper limit is 140 mg/dl (Association, 2001). The weak positive linear correlation between BG and BMI values is observed for the preprandial state of the ND subjects, whereas no dependence is found for their postprandial state. On the other hand, T2D patients (blue symbols in Fig. 3) have in average both higher BMI ($\sim 28 - \sim 43$ kg/m²) and BG (83 – 222 mg/dl) values than ND subjects. There is also a weak positive linear relationship between BMI and BG values for both preprandial and postprandial status in T2D patients. This is consistent with the study performed on 83 T2D patients, where a significant linear correlation between BMI and BG level was determined (Amelia, 2017:3606). Finally, for a small number of the collected T1D patient data (red symbols in Fig. 3), BG values range from 119 to 262 mg/dl, which is in average much higher than BG values

for ND and T2D patients. Overall, the ranges of the measured BG values of 3 different DM classes are found to be within the expected limits according to the previous studies done with a higher amount of data.

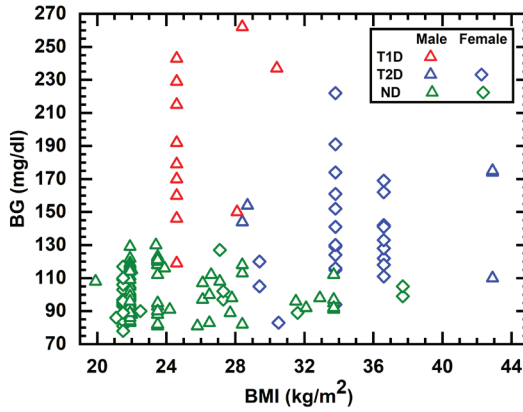

Fig. 3: Correlation found between glucometer-measured BG and BMI.

Correlation between BG and BA values

The 141 BG and BA data collected for all 3 DM classes at both preprandial and postprandial status is presented in Fig. 4. The maximum acetone concentration is found to be 6.74 ppm for T2D patients and 5.64 ppm for T1D patients, while this value was only 4.12 ppm for ND subjects. In the previous studies, it has been reported that the exhaled acetone level is generally 0.2–1.8 ppm in ND people, 1.25–2.5 ppm in DM patients, and may also increase up to 21 ppm (Turner et al., 2009) and 25 ppm (Masikini et al., 2020:167) in some T1D patients. In another study, it was reported that the BA value ranged between 0.22 ppm and 0.80 ppm in ND individuals and between 1.76 ppm and 3.73 ppm in DM patients (Deng et al., 2004). It should be noted that these ppm values are measured by different detectors/methods, while in the present study ppm level is recalculated from the commercial gas sensor output resistance values: the discrepancy between the absolute ppm values is possible, so the relative ppm level is rather considered in this study. Fig. 4 also suggests that while the BG values are in average much higher for T2D and T1D patients compared with ND people, the BA concentration of ND people does not much differ from that of diabetics: diabetics have higher BA than ND people for only 5 data out of 141. Similar result was found by Turner et al., where BA levels in T2D and especially T1D patients were not generally much higher than in ND subjects (Turner et al., 2009:1). Since a moderate positive correlation between BG and BA with a coefficient around 0.55 is found (not shown in

Fig. 4), it seems that a very strong BG-BA relationship can not be established. However, when the diabetic classes (ND, T2D, and T1D) and satiety status are taken into account and reexamined a much more meaningful relationships are obtained as it is shown in Fig. 5 via redrawn 6 different graphs. Some of these graphs were fitted with quadratic polynomial (Fig. 5a, b, c, d), while others were fitted with linear lines (Fig. 5e, f) as guides for eye. As a result of this fitting, the positive relationship between BG and BA was obtained for postprandial cases (Fig. 5 a, c, e, f), whereas for preprandial ND (Rydosz, 2015:881) and T2D cases the negative correlation is found to be present for low BA values overlapping with the positive one for high BA values (Fig. 5b, d). Such negative correlation at fasting state was previously found for volunteers experiencing ketogenesis (Güntner et al., 2018:3655). Therefore, for ND and T2D subjects in this work at their preprandial state two different processes, i.e. ketosis and normal hungry state, probably overlap to give this complex relationship between BG and BA (Fig. 5b, d). Since both linear and non-linear correlations are found for all 6 cases, a more complicated treatment of the 141 data together with 6 different parameters seems to be inevitable. Therefore, the training of this data with different regression classifiers is done to choose the best method to predict the BG values from the measured BA ones.

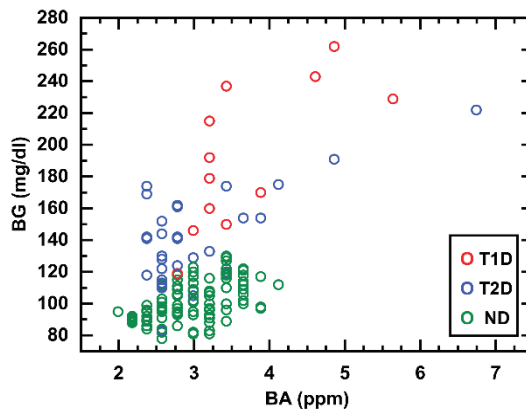

Fig. 4: Correlation found between glucometer-measured BG and BA values for ND, T2D and T1D subjects.

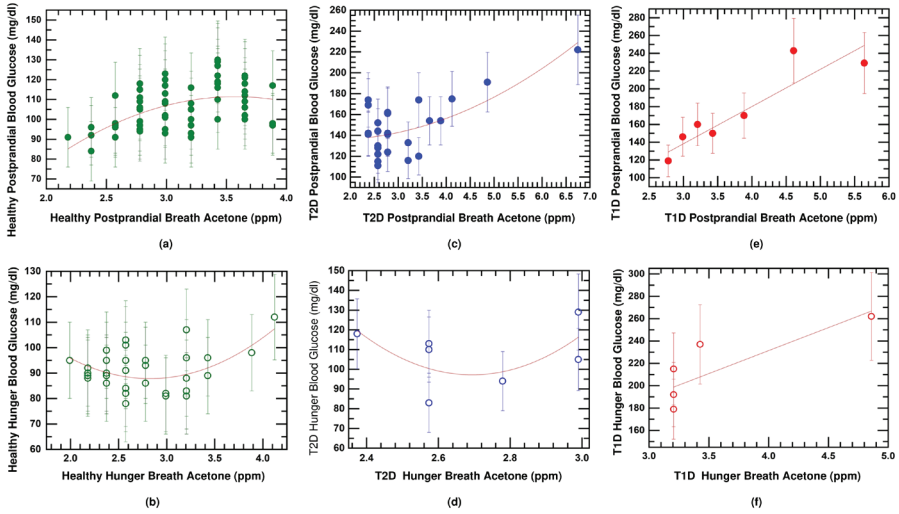

Fig.5: Correlation of the glucometer-measured BG and BA values redrawn separately for a) ND postprandial, b) ND preprandial, c) T2D postprandial, d) T2D preprandial, e) T1D postprandial and f) T1D preprandial subject

Training the data with PLR, MLP and SVR

The collected 141 data were trained with PLR, MLP and SVR (Table 3). The equations used for the determination of R^2 score, Mean Absolute Error (MAE) and Mean Absolute Percentage Error (MAPE) are provided in Equation 2, Equation 3 and Equation 4, respectively. As seen from the compared coefficient of determination (R^2 score), MAE and MAPE values, the best result is obtained by PLR method: $R^2=0.89$, MAE=9.18, MAPE=7.85%. The R^2 score provides information about the goodness of a model's fit: it is a statistical measure of how well the predicted BG values approximate the true BG values ('Coefficient of determination', 2022). The R^2 score is calculated to be 0.89 in this study, which is very close to its maximum value 1 ('Coefficient of determination', 2022). In addition, the MAE and MAPE values being equal to 9.18 mg/dl and 7.85%, respectively, indicate that the estimation accuracy of the proposed method can compete with that of the commercial glucometer: the MAE and MAPE values for the glucometer at hand are 15 mg/dl and 15%, respectively (*Bayer HealthCare Contour TS User Manual | Manualzz, 2022*). In this context, it is clear that the proposed method can be preferred for painless and high accuracy alternative BG measurement.

Table 3: BG training results obtained via PLR, MLP and SVR methods.

Metric	PLR	MLP	SVR
R ² score	0.89	0.76	0.09
MAE (mg/dl)	9.18	12.81	20.23
MAPE (%)	7.85	10.76	14.74

$$R^2(y, \hat{y}) = 1 - \frac{\sum_{i=1}^n (y_i - \hat{y}_i)^2}{\sum_{i=1}^n (y_i - \bar{y})^2} \quad (2)$$

$$MAE = \frac{1}{n} \sum_{\tau=1}^n |e_{\tau}| \quad (3)$$

$$MAPE = \frac{100\%}{n} \sum_{\tau=1}^n \left| \frac{e_{\tau}}{y_{\tau}} \right| \quad (4)$$

Evaluation of the BG values measured by the glucometer and predicted by PLR method

The comparison between the BG values measured by the glucometer and predicted via BA by PLR method is summarized in Table 4. The mean and SD of the glucometer-measured and predicted BG values are found to be very close to each other. The relationship between the predicted and measured BG values is examined further by plotting a scatter plot together with the line of equality, which is acting as a reference line ('Identity Line', 2021) (Fig. 6). This shows how far are the predicted BG values from the measured BG ones. If all the points lie along the line of equality (the black line in Fig. 6), it indicates a perfect agreement (Martin Bland & Altman, 1986). It is also observed that the BG values are mostly within the glucometer error band, which is shown by the gray region within the red lines in Fig. 6. This error range is drawn according to the standards imposed on the glucometers: at least 95% of BG values should be within the range of ± 15 mg/dl at BG concentrations < 100 mg/dl and $\pm 15\%$ at ≥ 100 mg/dl (Bayer HealthCare Contour TS User Manual | Manualzz, 2022).

Table 4: Descriptive statistics of BG prediction by PLR method.

N: 141	Max	Min	Mean	Median	SD
Measured BG (mg/dl)	262.00	78.00	117.13	108.00	35.09
Predicted BG (mg/dl)	266.00	87.00	117.12	106.00	33.20
Absolute Error (mg/ dl)	33.00	0.00	9.18	8.00	6.75
Absolute Perc. Error (%)	25.30	0.00	7.85	7.37	5.27

Indeed, out of 141 data at hand only 10 data is found to be outside this error band, i.e. ~93% of the predicted data is acceptable. Although the scatterplot of Fig. 6 is useful to compare the measured and predicted BG values, it is difficult to evaluate the differences between them: usually the data points cluster around the line (Martin Bland & Altman, 1986). Therefore, the Bland-Altman plot is also utilized to compare the predicted and measured BG values (Fig. 7) (Martin Bland & Altman, 1986:307; ‘Bland–Altman Plot’, 2022). Here it is important to compute the Mean value of the difference, its SD, the confidence intervals for 95% limits of agreement (LoA) (Martin Bland & Altman, 1986) (the red dashed lines in Fig. 7).

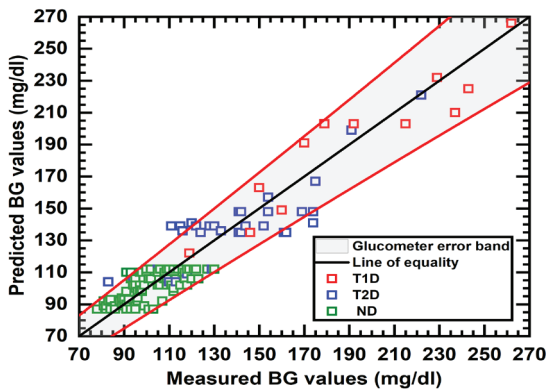
**Fig.6:** Correlation of the PLR predicted and glucometer-measured BG values for ND, T2D and T1D subjects.

The difference between the glucometer-measured and PLR predicted BG values for 141 data at hand resulted in Mean value of 0.007 mg/dl, its SD of 11.43 mg/dl, lower LoA of -22.39 mg/dl, upper LoA of 22.40 mg/dl. Since the difference between the two methods resulted in the very low Mean value (almost close to zero), the predicted and measured BG values are found to be in a good agreement.

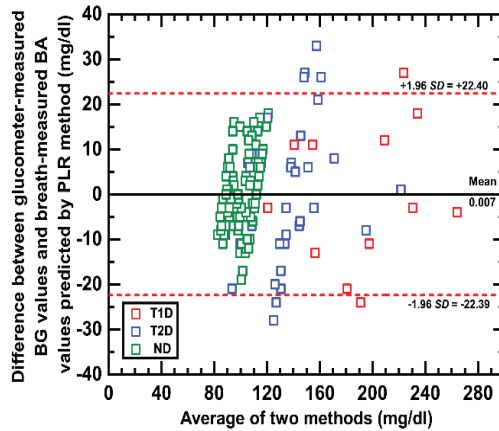

Fig. 7: *Bland-Altman plot for the glucometer-measured and predicted by PLR method BG values.*

CONCLUSION AND FUTURE WORK

It has been shown in this study that the acetone in the human breath can be properly detected via a commercial MOS based Grove Air Quality v1.3 gas sensor and this BA value can be used for the blood glucose prediction for diabetic and nondiabetic people. BA values were compared with the simultaneously glucometer-measured BG values. 141 data was collected from ND individuals and T2D, T1D patients with a wide range of ages, BMI and BG levels. The diabetes status in 3 categories and the satiety status in 2 categories for the first time were included into the training of this measured data. This data was trained with PLR, MLP and SVR methods, and the training results were tested. The best test result was found by PLR method with R^2 score of 0.89, MAE of 9.18 mg/dl and MAPE of 7.85%. These results show that it is possible to predict BG levels by the measured BA within the acceptable error. This study gives an opportunity for measuring BG in a non-invasive, cheap and reliable manner. Since the BG level acquisition in the current research was done by home-based glucometer device and was limited to a small number of diabetic subjects, this work should be considered as a preliminary study. For more realistic comparison between BA and BG, the venous BG values should be obtained in the clinical setting. In addition, to increase the accuracy of the proposed method, the venous BG and BA values should be acquired from a higher number of volunteers with repeated measurements over a certain period of time. It is also suggested to increase the number of the parameters related to the patients' physical characteristics, like BMI, age, gender, waist circumference etc., and include these parameters in the ML training.

Acknowledgment

This work was supported in part by the Karabuk University (KBU) Coordinatorship of Scientific Research Projects.

References

- Abma, R. K. (2021). *Blood Sugar Monitoring: When to Check and Why | Diabetic Check | DSM*. Diabetes Self-Management. Retrieved 13 May 2021, from <https://www.diabetesselfmanagement.com/managing-diabetes/blood-glucose-management/blood-glucose-monitoring-when-to-check-and-why/>
- Amelia, R. (2017). The Correlation Between Body Mass Index and Self-Efficacy with Blood Glucose Level in Type 2 Diabetes Mellitus. *Advanced Science Letters*, 23(4), 3606–3609.
- American Diabetes Association. (2014). Diagnosis and Classification of Diabetes Mellitus. *Diabetes Care*, 37(Supplement_1), S81–S90.
- American Diabetes Association. (2020). 7. Diabetes Technology: *Standards of Medical Care in Diabetes—2020*. *Diabetes Care*, 43(Supplement 1), S77–S88.
- Association, A. D. (2001). Postprandial Blood Glucose. *Diabetes Care*, 24(4), 775–778.
- Bayer HealthCare Contour TS User Manual | Manualzz*. (n.d.). Manualzz.Com. Retrieved 3 February 2022, from <https://manualzz.com/doc/55223320/bayer-healthcare-contour-ts-user-manual>
- Biondi, K., Al-Masri, E., Baiocchi, O., Jeyaraman, S., Pospisil, E., Boyer, G., & de Souza, C. P. (2019). Air Pollution Detection System using Edge Computing. *2019 International Conference in Engineering Applications (ICEA)*, 1–6.
- Bland–Altman plot. (2022). In *Wikipedia*. https://en.wikipedia.org/w/index.php?title=Bland%E2%80%93Altman_plot&oldid=1063901875
- Bovey, F., Cros, J., Tuzson, B., Seyssel, K., Schneiter, P., Emmenegger, L., & Tappy, L. (2018). Breath acetone as a marker of energy balance: An exploratory study in healthy humans. *Nutrition & Diabetes*, 8(1), 50.
- Chang, C.-C., & Lin, C.-J. (2011). LIBSVM: A library for support vector machines. *ACM Transactions on Intelligent Systems and Technology*, 2(3), 1–27.
- Coefficient of determination. (2022). In *Wikipedia*. https://en.wikipedia.org/w/index.php?title=Coefficient_of_determination&oldid=1067677444
- Deng, C., Zhang, J., Yu, X., Zhang, W., & Zhang, X. (2004). Determination of acetone in human breath by gas chromatography–mass spectrometry and solid-phase microextraction with on-fiber derivatization. *Journal of Chromatography B*, 810(2), 269–275. [https://doi.org/10.1016/S1570-0232\(04\)00657-9](https://doi.org/10.1016/S1570-0232(04)00657-9)
- Dhatariya, K. K., Glaser, N. S., Codner, E., & Umpierrez, G. E. (2020). Diabetic ketoacidosis. *Nature Reviews Disease Primers*, 6(1), 40.
- Fellinger, P., Fuchs, D., Wolf, P., Heinze, G., Luger, A., Krebs, M., & Winhofer, Y.

- (2019). Overweight and obesity in type 1 diabetes equal those of the general population. *Wiener Klinische Wochenschrift*, 131(3–4), 55–60.
- Galassetti, P. R., Novak, B., Nemet, D., Rose-Gottron, C., Cooper, D. M., Meinardi, S., Newcomb, R., Zaldivar, F., & Blake, D. R. (2005). Breath Ethanol and Acetone as Indicators of Serum Glucose Levels: An Initial Report. *Diabetes Technology & Therapeutics*, 7(1), 115–123.
- Garber, A. J. (2012). Obesity and type 2 diabetes: Which patients are at risk? *Diabetes, Obesity and Metabolism*, 14(5), 399–408.
- Géron, A. (2017). *Hands-on machine learning with Scikit-Learn and TensorFlow: Concepts, tools, and techniques to build intelligent systems* (First edition). O'Reilly Media.
- Gong, Z. (2014). A Ringdown Breath Acetone Analyzer: Performance and Validation Using Gas Chromatography-Mass Spectrometry. *Journal of Analytical & Bioanalytical Techniques*, S7 (012).
- Güntner, A. T., Kompalla, J. F., Landis, H., Theodore, S., Geidl, B., Sievi, N., Kohler, M., Pratsinis, S., & Gerber, P. (2018). Guiding Ketogenic Diet with Breath Acetone Sensors. *Sensors*, 18(11), 3655.
- Guo, D., Zhang, D., Zhang, L., & Lu, G. (2012). Non-invasive blood glucose monitoring for diabetics by means of breath signal analysis. *Sensors and Actuators B: Chemical*, 173, 106–113.
- Identity line. (2021). In *Wikipedia*. https://en.wikipedia.org/w/index.php?title=Identity_line&oldid=1029349730
- Jayne, J. M., Blake, C. E., Frongillo, E. A., Liese, A. D., Cai, B., Nelson, D. A., Kurina, L. M., & Funderburk, L. (2019). Trajectories of body mass index among active-duty U.S. Army soldiers, 2011–2014. *Preventive Medicine Reports*, 14, 100818.
- Keto Breath Monitor -KT003W*. (2021). Ketosischeck. Retrieved 13 May 2021, from <https://ketosischeck.com/products/keto-breath-monitor-kt003w>
- Ketonix Clinic*. (2022). KETONIX Breath Ketone Analyzer. Retrieved 5 February 2022, from <https://www.ketonix.com/site-home/ketonix-clinic>
- Kharroubi, A. T. (2015). Diabetes mellitus: The epidemic of the century. *World Journal of Diabetes*, 6(6), 850.
- Kovatchev, B. P. (2012). Diabetes Technology: Markers, Monitoring, Assessment, and Control of Blood Glucose Fluctuations in Diabetes. *Scientifica*, 2012, 1–14.
- Lekha, S., & M., S. (2018). Real-Time Non-Invasive Detection and Classification of Diabetes Using Modified Convolution Neural Network. *IEEE Journal of Biomedical and Health Informatics*, 22(5), 1630–1636.
- Lekha, S., & M., S. (2021). Recent Advancements and Future Prospects on E-Nose Sensors Technology and Machine Learning Approaches for Non-Invasive Diabetes Diagnosis: A Review. *IEEE Reviews in Biomedical Engineering*,

14, 127–138.

- Luaibi, A. Y., Al-Ghusain, A. J., Rahman, A., Al-Sayah, M. H., & Al-Nashash, H. A. (2015). Noninvasive blood glucose level measurement using nuclear magnetic resonance. *2015 IEEE 8th GCC Conference & Exhibition*, 1–4.
- Maharjan, P. (2018). *Development of IoT Educational Platform* [Fi=AMK-opin-
näytetyö|sv=YH-examensarbete|en=Bachelor's thesis]. Metropolia Am-
mattikorkeakoulu. <http://www.theseus.fi/handle/10024/147250>
- Maillard, G., Charles, M., Thibult, N., Forhan, A., Sermet, C., Basdevant, A., & Eschwège, E. (1999). Trends in the prevalence of obesity in the French adult population between 1980 and 1991. *International Journal of Obesity*, 23(4), 389–394.
- Martin Bland, J., & Altman, Douglas G. (1986). STATISTICAL METHODS FOR ASSESSING AGREEMENT BETWEEN TWO METHODS OF CLINI-
CAL MEASUREMENT. *The Lancet*, 327(8476), 307–310.
- Masikini, M., Chowdhury, M., & Nemraoui, O. (2020). Review—Metal Oxides: Application in Exhaled Breath Acetone Chemiresistive Sensors. *Journal of The Electrochemical Society*, 167(3), 037537.
- Mp503 English.pdf*. (2021). Retrieved 1 December 2021, from https://files.seeed-studio.com/wiki/Grove_Air_Quality_Sensor_v1.3/res/Mp503%20English.pdf
- Müller, A. C., & Guido, S. (2016). *Introduction to machine learning with Python: A guide for data scientists* (First edition). O'Reilly Media, Inc.
- Musoro, T. K. A. (2019). *Indoor Air Quality Monitoring System for Homes Using Solid Fuels: A Universal Design Approach Integrating Sensor Network with Human Computer Interaction*. <https://oda.oslomet.no/oda-xmlui/handle/10642/8637>
- Rabih, A. A. S., Dennis, J. O., Ahmed, A. Y., Khir, M. H. M., Ahmed, M. G. A., Idris, A., & Mian, M. U. (2018). MEMS-Based Acetone Vapor Sensor for Non-Invasive Screening of Diabetes. *IEEE Sensors Journal*, 18(23), 9486–9500.
- Report of a WHO Consultation on Obesity: preventing and managing the global epidemic*. Geneva, 1997 (2000).
- Rydosz, A. (2015). A Negative Correlation Between Blood Glucose and Acetone Measured in Healthy and Type 1 Diabetes Mellitus Patient Breath. *Journal of Diabetes Science and Technology*, 9(4), 881–884.
- Saeedi, P., Petersohn, I., Salpea, P., Malanda, B., Karuranga, S., Unwin, N., Colagiuri, S., Guariguata, L., Motala, A. A., Ogurtsova, K., Shaw, J. E., Bright, D., & Williams, R. (2019). Global and regional diabetes prevalence estimates for 2019 and projections for 2030 and 2045: Results from the International Diabetes Federation Diabetes Atlas, 9th edition. *Diabetes Research and Clinical Practice*, 157, 107843.

- Saraoglu, H. M., Selvi, A. O., Ebeoglu, M. A., & Tasaltin, C. (2013). Electronic Nose System Based on Quartz Crystal Microbalance Sensor for Blood Glucose and HbA1c Levels From Exhaled Breath Odor. *IEEE Sensors Journal*, 13(11), 4229–4235.
- Sun, meixui, Chen, Z., Zhao, X., Sun, M., Li, Y., Wang, Z., & Wang, C. (2017). Continuous Monitoring of Breath Acetone, Blood Glucose and Blood Ketone in 20 Type 1 Diabetic Outpatients Over 30 Days. *Journal of Analytical & Bioanalytical Techniques*, 08(05).
- Tayyab Hassan, Talha Rehman, Aziz, Q. A., & Salman, A. (2018). *Blood Glucose Level Measurement From Breath Analysis*.
- Thati, A., Biswas, A., Roy Chowdhury, S., & Kumar Sau, T. (2015). BREATH ACETONE-BASED NON-INVASIVE DETECTION OF BLOOD GLUCOSE LEVELS. *International Journal on Smart Sensing and Intelligent Systems*, 8(2), 1244–1260.
- Towakel, P., Guness, S. P., Seem, A., Bekaroo, G., & Bellekens, X. A. (2018). Air Quality Monitoring in Mauritius. *2018 International Conference on Intelligent and Innovative Computing Applications (ICONIC)*, 1–5.
- Trotter, M. D., Sulway, M. J., & Trotter, E. (1971). The rapid determination of acetone in breath and plasma. *Clinica Chimica Acta*, 35(1), 137–143.
- Turner, C. (2011). Potential of breath and skin analysis for monitoring blood glucose concentration in diabetes. *Expert Review of Molecular Diagnostics*, 11(5), 497–503.
- Turner, C., Walton, C., Hoashi, S., & Evans, M. (2009). Breath acetone concentration decreases with blood glucose concentration in type I diabetes mellitus patients during hypoglycaemic clamps. *Journal of Breath Research*, 3(4), 046004.
- Vapnik, V. N. (2000). *The Nature of Statistical Learning Theory*. Springer New York : Imprint : Springer. <http://public.ebookcentral.proquest.com/choice/publicfullrecord.aspx?p=3086234>
- Yan, K., & Zhang, D. (2012). A novel breath analysis system for diabetes diagnosis. *2012 International Conference on Computerized Healthcare (ICCH)*, 166–170.
- Yuan, X., Wang, J., Yang, S., Gao, M., Cao, L., Li, X., Hong, D., Tian, S., & Sun, C. (2020). Effect of the ketogenic diet on glycemic control, insulin resistance, and lipid metabolism in patients with T2DM: A systematic review and meta-analysis. *Nutrition & Diabetes*, 10(1), 38.

“

Chapter 8

A REVIEW OF NATURAL SYSTEMS FOR WASTEWATER TREATMENT

Nurdan BAYKUŞ¹

”

¹ Asst. Prof. Dr., Kilis 7 Aralık University, Vocational School of Technical Sciences, ORCID ID: 0000-0002-6199-3363, nurdanbaykus@kilis.edu.tr

1. Introduction

Water is one of the most important elements on earth. Because without water, there is no life on earth. Water is of vital importance to every living thing on earth. The surface of the world is covered with water about 75% but only 2.5% of this water is freshwater (Rajasulochana & Preethy, 2016). Industrialization, rapid urbanization, population growth, and environmental pollution significantly change the existing freshwater quality. In addition, the water demand is continuously increasing (Seow et. al., 2016). For this reason, the focus is on reducing the need for freshwater resources worldwide, protecting water resources, and developing savings and measures to prevent water pollution (Karpuzcu et. al., 2020).

The scarcity of water resources is one of the main problems of today, but it is growing rapidly around the world. More than 100 countries worldwide are facing water scarcity due to population growth. It is predicted that by the year 2025, two-thirds of the global population will be experiencing moderate to high levels of severe water shortage (Zhang & Shen, 2017). For this reason, worldwide wastewater treatment and wastewater reuse have been recognized as alternative ways to overcome water scarcity (Zacharia et. al., 2020). It is also a suitable option among the savings and measures developed to reduce the pressure on water resources. However, it may be difficult to meet the costs of establishing, operating, and maintaining technological wastewater treatment plants due to the global economy and energy crisis in many developed and developing countries. For this reason, countries are starting to implement low-cost and low-energy natural wastewater treatment systems for industrial and domestic wastewater treatment (Mahmood et. al., 2013). The percentages of untreated wastewater in 2015 and aspirations for 2030 of countries with different income levels are given in Figure 1 (WWAP, 2017). Considering the levels of wastewater treatment overall, it can be said that significant investments may be required to improve the existing capacity for wastewater treatment and reuse (Sato et. al., 2013).

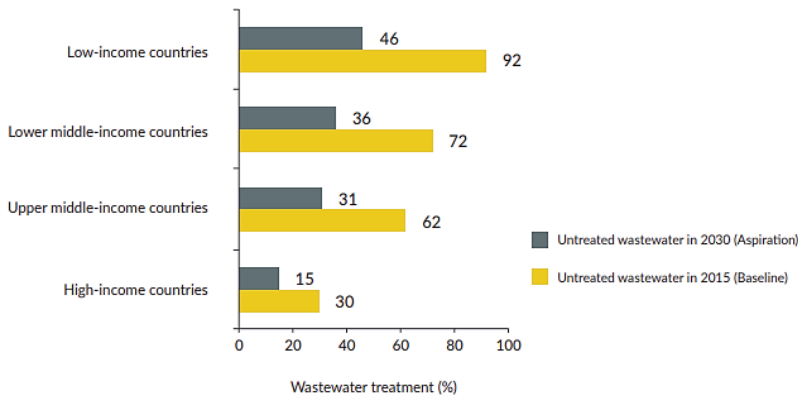

Figure 1. Percentage of untreated wastewater in countries with different income levels (WWAP, 2017).

Natural wastewater treatment is a system that requires no or little electrical energy. It has low maintenance and operating costs, low energy consumption, and technology, so it can be ideal for sustainable and recyclable services, especially in developing countries (Mahmood et. al., 2013).

Natural wastewater treatment systems can be applied in different alternatives to provide solutions to wastewater problems in settlements that do not have a central sewer system or have limited resources/opportunities. Commonly used natural treatment systems and their usage possibilities are given in Table 1 (Rozkošný et. al., 2014). Each treatment system has different performance characteristics and different direct or indirect effects on the environment (Seow et. al., 2016). For this reason, a holistic approach to the evaluation of methods is important.

Natural wastewater treatment systems are often preferred in restaurants, hotels, summer camps, small facilities, and farms, from dwellings to settlements with up to 2000 inhabitants population. Natural wastewater treatment systems have a conceptually known and centuries-old history (Zhang & Shen, 2017). However, today, it not only follows its historical tradition but also develops with natural treatment technologies, allowing water to be improved in a high quality controlled way. In fact, natural wastewater treatment is a self-treatment process by means of microorganisms and plants, which are formed by absorption, sedimentation, soil, and water filtration, etc., and are directly involved in the remediation process (Rozkošný et. al., 2014).

This chapter provides information on the design, applicability, and efficiency of different natural wastewater treatment systems. It offers the opportunity to compare these systems. It also presents the advantages and disadvantages of various natural treatment systems.

2. Natural Wastewater Treatment Systems

Natural wastewater treatment systems are highly nature-based solutions and, wherever applicable, can offer sustainable, low-energy, and low-cost options for a series of wastewater problems such as protecting surface water and water resources and supporting and enhancing natural diversity (Gray, 2021).

Natural wastewater treatment systems rely on completely natural factors like soil environment, filtration, microorganisms, sedimentation, absorption, plants, temperature, light, etc. to treat wastewater. The removal or separation of pollutants from wastewater is based on naturally occurring physicochemical, biological, and ecological processes (Zacharia et. al., 2020). Besides the removal of pollutants from wastewater with high efficiency with these systems, advantages related to their reuse can be achieved

(Ayaz & Akca, 2000). However, the type, content, and characterization of wastewater are important to establish an efficient system (Üçüncü, 2019). The treatment of wastewater with high organic matter content, containing oil derivatives such as solid and liquid oils, and without any pre-treatment is not suitable for natural wastewater treatment systems (Rozkošný et. al., 2014). However, since domestic wastewater constitutes the type of wastewater originating from domestic activities in residential settlements, they generally do not contain relatively free hazardous substances (WWAP, 2017).

Table 1. Use of natural wastewater treatment systems (Rozkošný et. al., 2014).

Type	Usage Opportunities in Facilities
‘Soil (Ground) Filters’	
Vertical or horizontal flow without vegetation	Treatment of storm and sewerage water for small and medium group
‘Constructed Treatment Wetland’	
A composition of surface and horizontal sub-surface flow, horizontal surface	Polluted surface water and wastewater treatment in suitable climatic conditions
Horizontal sub-surface flow, vertical flow with intermittent flow, or vertical flow downwards	Sewage treatment operating throughout the year
Vertical flow upwards	Wastewater treatment preponderantly in summer
‘Waste Stabilization Ponds’	
Aerobic low-loaded or high-loaded	Wastewater treatment and runoff, Wastewater treatment in climatically favorable areas
Aerobic incessantly with ventilation	Intense wastewater treatment, uninterrupted aeration
Last treatment	The last treatment of wastewater after the biological treatment stages
Anaerobic or anaerobic storage	Anaerobic treatment pre-ranked aerobic treatment or wastewater treatment of campaign manufacturers

Soil (ground) filters, constructed wetlands, and waste stabilization ponds are widely natural wastewater treatment systems used to treat wastewater from polluting sources. Although only one of these systems can be applied, they can also be applied together as part of each other. These systems can effectively remove a variety of wastewater contaminants, nutrients, containing organic matter, a number of harmful chemicals, and pathogens (Stott et. al., 2003; Zacharia et. al., 2020).

2.1. Soil Filters

Soil filtration or on-site wastewater treatment systems traditionally use the land to treat wastewater. Although the filtering function of the soil is an important ecosystem service, the filtration efficiency can vary depending

on many factors such as pollutant concentration, hydrological and topographic characteristics, soil properties and clay mineral presence, climatic conditions, and time (Keesstra et. al., 2012). Large lands and fencing may be needed to insure minimum human exposure when these systems are used. Also, due to the structure of these systems, they include an important pre-process before the application (Mahmood et. al., 2013).

The treatment system is based on the infiltration of the wastewater, which is generally pre-treated in a settling or septic tank, passing through the sand-gravel filter layer and pipes into the soil where the treatment takes place. Soil filters can be designed with vertical, horizontal, or radial filter flows in saturated, partially saturated, and unsaturated filtration media. The combination of these filters is rarely created (Rozkošný et. al., 2014). Pre-treatment or retention systems can be designed to retain wastewater at a minimum rate for a minimum retention period of 36 hours under anaerobic conditions. During this period, a high percentage of settleable organic and inorganic solids are removed from the wastewater (Muralikrishna & Manickam, 2017). Then, water is infiltrated into excavated areas at different filtration layer depths depending on the wastewater type (usually natural soils built in an excavation of 50-100 cm). Perforated pipes of 10 cm can be used to distribute the wastewater throughout the excavation. The pipes are surrounded by large stones to improve the water distribution process. To support a uniform distribution of wastewater over the entire floor base area, it must be provided to pass through a flat foundation and surface area to allow for seepage (Lavigne, 2005). The filtering function, which can be characterized by its absorption capacity, largely depends on the type of soil. Therefore, soil filtration fields need to be evaluated individually for each case. In addition, design, performance, and application limits should be defined. Figure 2 shows a simply designed soil filter field.

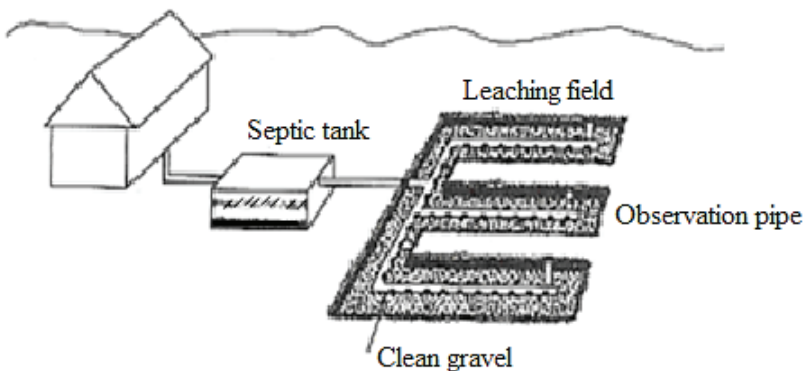

Figure 2. Leaching field after septic tank on natural soils (Url-1).

Since it is difficult to control the discharge of wastewater directly to the soil surface or the receiving environment and is carried out in accordance with regulations, it is appropriate to use filtration areas not for wastewater treatment, but for slow discharge of pre-treated water (Mlejnská & Rozkošný, 2016). Thus, most organic compounds and nutrients in wastewater can be retained during infiltration from the first few centimeters of soil by vegetation and soil microorganisms. The cleaned water is then absorbed by the deep-rooted vegetation or passes from the soil into the groundwater (Mahmood et. al., 2013). For this reason, soil filters are not suitable for areas with high groundwater levels.

Soil infiltration systems can usually be designed for places with a population of less than 2500. Although they need special site conditions, they can be a low-cost and well-maintained method of wastewater disposal. Filtration systems can be designed for the treatment of various sorts of wastewater, such as domestic wastewater, landfill leachate, agricultural drainage, and meat and dairy processing wastewater (Mahmood et. al., 2013). Table 2 presents the advantages and disadvantages of soil filter systems.

Table 2. Advantages and disadvantages of soil filters (Rozkošný et. al., 2014).

<i>Advantages of soil filters</i>	<i>Disadvantages of soil filters</i>
Energy-efficient treatment systems operate without energy demand, low operating costs, and maintenance.	It needs a large surface area.
Achieving high treatment efficiency with the right design.	There is a risk of clogging the filter material if it is not designed correctly.
Soil filters in unsaturated filtration media can be suitable for ammonia pollution removal	It is difficult to follow the condition of the filtration media and the filtration process.
With a suitable arrangement, it is possible to backwash the filters with treated wastewater.	Soil filters with a saturated filtration medium may inadequately remove ammonia contamination.
Soil filters can be designed without vegetation, only with the soil surface layer. Sowing pasture or specially selected plants to the surface is an alternative.	
A homogeneous or heterogeneous, arrangement in layers and single and multiple-stage arrangements with various filter materials	

2.2. Constructed Treatment Wetlands

Wetlands are water-dependent areas where the water table is at or above ground level (>0.6 m). Plants and bacteria in the structure of wetlands have a role in the filtration and absorption of pollutants in wastewater (Yinanç & Adiloğlu, 2017). Constructed wetland treatment systems are

engineered systems designed and built to use natural processes, including wetland vegetation, soil, and their associated microbial communities, to help treat wastewater (Nikolić et. al., 2010). The flow and direction of the wastewater passing through the defined filter system in the treatment are important. There are three varieties of constructed wetlands that are used. These can be counted as sub-surface flow-formed wetlands, surface flow-generated wetlands, and hybrid systems composed of sub-surface flow and surface flow systems. Types of constructed wetlands and their components are shown in Figure 3. It can be stated that the two most important criteria in the creation of constructed wetlands are surface and subsurface water flow regimes (Nikolić et. al., 2010).

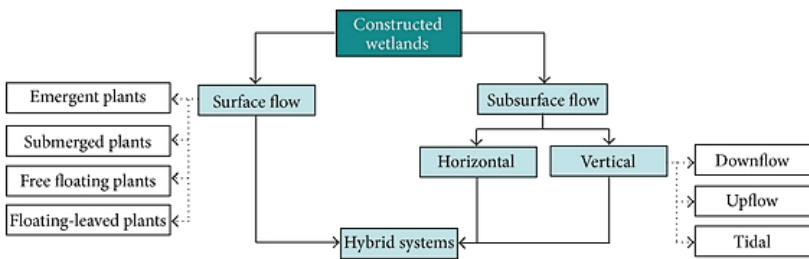

Figure 3. Basic types of constructed wetlands (Nikolić et. al., 2010).

Constructed treatment wetlands with surface flow comprise of channels or basins, with soil or suitable filter medium to support the vegetation and water at a low flow velocity. A subsurface flow-constructed wetland comprises a closed basin with a porous subgrade of gravel or rock. The water level is designed to remain below the top of the subgrade. Hybrid systems are used most frequently in vertical and horizontal subsurface flow systems arranged in a staged manner. The advantages of various systems in hybrid systems can be combined to complement each other (Nikolić et. al., 2010). Constructed treatment wetlands can be used to improve the quality of non-point and point sources of water pollution, such as municipal, industrial, agricultural, leachate water, coal mine drainage, stormwater runoff, etc (Omondi & Navalía, 2020). Table 3 presents the advantages and disadvantages of constructed wetlands.

Table 3. Advantages and disadvantages of constructed wetlands (Yigit & Kayranli, 2022).

<i>Advantages of constructed wetlands</i>	<i>Disadvantages of constructed wetlands</i>
They are systems with low construction, operation, and maintenance costs and energy consumption.	Requires larger areas than conventional wastewater treatment systems.
They can tolerate changes in the flow of wastewater.	Performance may be less stable than conventional treatment systems.
Helps improve water quality and create a natural environment for living things.	Treatment efficiency is affected more by seasonal and environmental changes.
They can be built by the landscape and provide an aesthetic appearance.	Fluctuations in pollutant concentration or flow rate can temporarily reduce treatment efficiency.
Provides the opportunity to reuse treated water.	It is the cultivation of aquatic plants used in treatment every year.
They are sustainable systems in terms of public interest.	

2.3. Wastewater Stabilization Ponds

Stabilization ponds are an important part of the systems of natural treatment. It has been widely used for sewage water treatment since 100 years ago (Wang et. al., 2016). Wastewater stabilization ponds are human-made shallow basins usually consisting of a single or series of ponds. They are used in wastewater treatment in settlements serving connected households in towns, villages, and cities (Zacharia et. al., 2020). Wastewater stabilization ponds are used for the treatment of agricultural, domestic, industrial, polluted surface waters, etc. Stabilization ponds are recognized as reliable wastewater treatment systems. The planted vegetation in these systems considerably increases the surface area of contact, which can help remove pollutants along the filter bed, commonly a combination of gravel and sand (WWAP, 2017). The desired treatment impact is achieved by chemical, biological, and physical processes occurring in the aquatic environment in the presence of aquatic plants and microorganisms. Stabilization ponds can be designed of different types and used to regulate these processes (Rozkošný et. al., 2014). Some advantages and disadvantages of stabilization ponds are given in Table 4.

Table 4. Advantages and disadvantages of wastewater stabilization ponds (Rozkošný et. al., 2014).

<i>Advantages of wastewater stabilization ponds</i>	<i>Disadvantages of wastewater stabilization ponds</i>
Natural treatment of pre-treated wastewater, harmonious integration with the environment and landscape.	The main disadvantage is the relatively high surface requirements for the construction of the biological tank system. This disadvantage should not be reflected in the occupation of unproductive or rather economically unusable land.
Low energy demands, comparable costs with artificial (machine) pre-treatment, and operating costs.	Lowly lower pollution removal purification effect in winter in the absence of artificial ventilation
Resistance to excessive hydraulic and pollution load in a short time.	Removal of sediments from specific tanks (sludge process) and their subsequent use. The need for the sludging process can be reduced if there is a quality mechanical pre-treatment system.
Pollution removal efficiency compared to conventional methods for wastewater treatment and highly efficient removal of bacterial contamination.	The costs of maintaining the environment of the surroundings of tanks may increase, and odor may occur due to the biological process.
Suitable combination with other natural wastewater treatment methods and especially irrigation with clarified wastewater, aquaculture, etc.	

2.4. Pretreatment Systems

The pre-treatment process is mainly based on the separation or removal of settleable solids, and suspended or colloidal particles from the wastewater by the sedimentation process. A significant portion of pollutants in wastewater are associated with large particles. Particles removed from the water with pre-treatment can ensure that the treatment is exposed to less pollutant load in the next steps and thus providing a more efficient treatment (Van Nieuwenhuijzen et. al., 2001). The biological process activity of wastewater at this stage is of negligible importance. Because the purpose of pre-treatment is to decrease the velocity of wastewater to allow solids to settle and floating substances to rise to the surface. Therefore, pre-treatment systems can consist of settling tanks, clarifiers, or additional units where chemicals are used. Due to differences in design, operation, and application, it can be divided into groups into settling tanks, septic tanks, two storey tanks, or mechanical sludge removal tanks (Muralikrishna & Manickam, 2017).

Septic tanks are one of the oldest treatment systems used. Wastewater treatment can be achieved in small population groups such as individual households, schools, hotels, etc. Septic tanks are designed to hold wastewater at a minimum velocity under anaerobic conditions (Muralikrishna &

Manickam, 2017). In this way, more than 70% of settleable solids can be reduced with septic tanks (Wang et. al., 2016). The final effluent disposal takes place by subsurface methods. The effectiveness of this system is dependent on the infiltration ability of the soil. When the wastewater settled in the tank is disposed of to the field, it should not lead to the clogging of soil pores and excessive organic loading (Muralikrishna & Manickam, 2017).

Factors such as the retention time, velocity, density, and solids concentration of the wastewater can affect the design and performance of primary or pre-treatment tanks. The most important design criterion is to determine the appropriate retention time and surface overflow rate (Muralikrishna & Manickam, 2017).

2.5. Membrane Systems

Membrane filtration, which is perhaps one of the fastest-growing systems in the wastewater treatment sector, is a promising system that can meet the treatment requirements. Advances in the membrane system have not only decreased environmental and human health risks related to treated wastewater but have also opened up new opportunities for wastewater use, such as to use it again as drinking water. As these developments continue and operating costs decrease, the use of membrane systems (microfiltration, ultrafiltration, nanofiltration, etc.) for tertiary systems or advanced treatment is becoming increasingly common (WWAP, 2017).

In 1906, the term ‘ultrafiltration’ was first used, and then microporous filters began to be developed. Until 1945, microporous membranes were used for the removal of microorganisms and particles. In the 1980s, nanofiltration membranes began to be produced with the advancement of manufacturing and application technology and a new worldwide process began for membrane systems (Yıldız et. al., 2013).

Generally, a membrane can be defined as a thin or thick permeable layer that separates two phases or media and allows substances to be selectively transferred from one side to the other. Membranes can be produced naturally or synthetically. Today, synthetic membranes are mostly used in filtration applications (Koyun, 2020). Membranes can provide high-quality effluent water and allow direct water recovery along with the removal of many bacteria, viruses, and pathogens (Yıldız et. al., 2013). By the working principle of the membranes, since the substances are kept on the membrane surface during the passage of water, they may form layers and cause blockages. The membrane may need to be cleaned or replaced with a new one to avoid this situation (Koyun, 2020). Table 5 presents the main advantages and disadvantages of membrane systems.

Table 5. Advantages and disadvantages of membrane processes (Aslan, 2016).

<i>Advantages of membranes</i>	<i>Disadvantages of membranes</i>
Since they can separate particles at a visible scale, even at molecular size, many processes that require separation can be met by membrane processes.	Membranes may have chemical incompatibility with process solutions. This reduces efficiency and can increase costs.
Membrane processes present a very simple flow chart. Operating controls are not complicated. Equipment needs are minimal and can offer a low maintenance repair option.	Polymeric membrane modules are generally not possible to operate at high temperatures. In processes that require high temperatures, the structures of the membranes may deteriorate in a short time.
Relatively simple and harmless materials can be used in membrane processes.	Production and marketing costs are high.
They can provide reliable and reasonably good effluent quality even at high concentrations.	Depending on the feed flux and concentrations in the membrane processes, it can become dirty in a short time and its pores can become clogged. Contamination of membranes and clogging of pores cause low flux. It also increases the cost as it requires short-term replacement or cleaning of the membranes.
They can be designed as modular and are not limited to a certain size.	They are applied in two or three stages when the single-stage operation is difficult.
They use less energy. They are portable and do not require any construction.	

Figures 4, 5, and 6 show a simple membrane separation diagram. Microfiltration membranes constitute a pre-treatment process for other membranes. In general, the substances retained in the membranes can vary depending on the molecular size of the substance, its shape, the pore diameter of the membrane, or the permeability coefficient (Koyun, 2020).

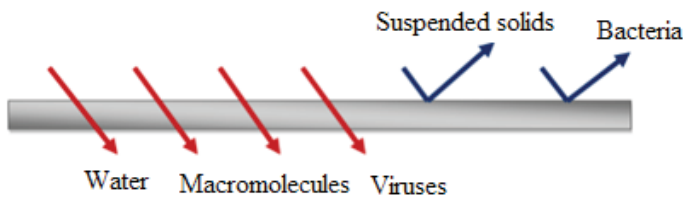

Figure 4. Microfiltration membrane separation process (Yazıcı, 2012).

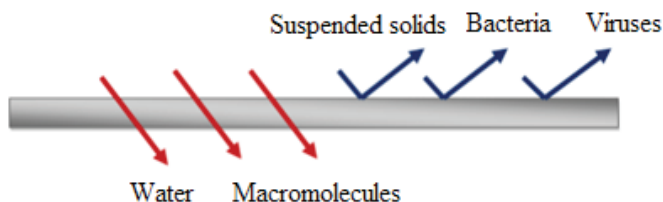

Figure 5. Ultrafiltration membrane separation process (Yazıcı, 2012).

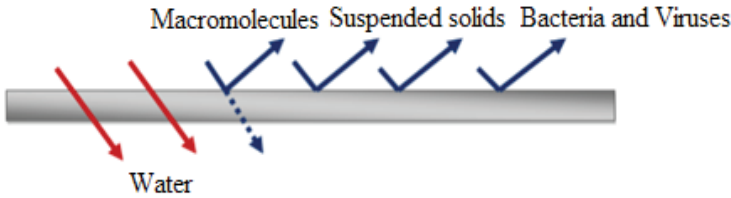

Figure 6. Nanofiltration membrane separation process (Yazıcı, 2012).

2.6. Activated Sludge Method

The activated sludge process is an interrelated multi-chamber reactor unit that uses high concentrations of microorganisms to separate organic matter and nutrients from the water in the treatment of wastewater. The base principle of activated sludge is that as the microorganisms grow, the collected particles settle to the bottom of the tank and the relatively clear water is taken into a second tank. A source of aeration is needed for the process and a collection means to reprocess the settled solids, i.e. active sludge, from the process. Partially cleaned water which can be separated from some of the bacteria with the second tank flows for further treatment if necessary (Muralikrishna & Manickam, 2017).

Table 6. Advantages and disadvantages of activated sludge processes (Anlı & Şanlı, 2019).

<i>Advantages of activated sludge processes</i>	<i>Disadvantages of activated sludge processes</i>
It is easy to apply and has low installation costs.	High energy consumption and sludge production occur.
Its compact design is sufficient, it has a small space requirement.	It requires suitable methods for the disposal of the sludge formed.
A high waste load can be taken into the system and toxic components can be diluted.	Effective control of the process can be difficult.
It can be applied to small systems.	Depending on the waste's composition, the treatment's success may vary.
Good quality water can be obtained.	The sludge activity must maintain during the process.

3. Advantages and Limitations of The Natural Treatment Systems

The advantages and disadvantages in the selection of commonly used natural treatment systems and their related systems are given separately in table 2, table 3, table 4, table 5, and table 6. In general, the advantages and disadvantages of these systems are presented below.

The advantages of natural treatment systems can be counted as follows mainly in the wastewater's natural character, the system chosen for wastewater treatment, and the possibility of being incorporated into a favorable environment (Rozkošný et. al., 2014; Yavaş, 2017).

- They are efficient treatment systems with the relatively simple technological application, easy to operate and maintain, and low energy consumption.

- Initial investment and operating costs are lower than central treatment systems.

- It provides treatment and improvement of wastewater in places where there is no central wastewater treatment plant.

- It ensures the protection and feeding of groundwater resources.

- There is a possibility of short or long-term shutdown or non-use.

- After starting the operation, it is possible to reach the performance productivity quality target in a short time.

- No need for a permanent workforce in its operation.

- The use of treated wastewater for irrigation or other uses provides benefits in terms of economy and sustainability.

The disadvantages of natural treatment systems are primarily due not to the technology of natural treatment systems, but to the incorrect design and lack of functionality of the mechanical pre-treatment phase, which creates conditions for rapid clogging (Rozkošný et. al., 2014). In general, the disadvantages of natural treatments can be listed as follows (Rozkošný et. al., 2014; Yavaş, 2017).

- It has relatively high land requirements.

- It may be possible to combine several methods or systems to achieve satisfactory efficiency.

- Natural treatment systems are generally designed for the treatment of domestic wastewater. They are not suitable for the treatment of wastewater with high organic matter content, containing various oil derivatives, and without any pre-treatment.

- According to the applied system, regular monitoring and maintenance may be required to reuse the treated water.

- Most wastewater treatment systems may not be sufficient for nitrogen removal.

4. Natural Treatment Systems Design Parameters

While designing natural wastewater treatment systems, parameters such as wastewater characterization, daily volume, flow rate, and pollution load or concentration should be determined meticulously. These parameters are important for the correct selection, operation, and optimum treatment efficiency of the system (Yavaş, 2017).

Natural treatment systems can be divided into resident systems and non-residential systems. While places such as detached houses, apartments, and hotels constitute the settled systems, the wastewater characterization of these systems can be determined depending on the characteristics such as the household or households' water savings and the number of users (Anderson & Siegrist, 1989). Wastewater characterization may vary in places where non-residential systems are formed. Organic loads can be very high in unsettled systems, and the level of economic income may cause the wastewater characterization to change in some places. For this reason, separate studies should be carried out to characterize wastewater and determine the pollution load in the design of resident and non-resident systems (Yavaş, 2017).

Other parameters to be considered in the design of natural wastewater treatment systems are the flow rate of the wastewater and the population. Wastewater flow rate and pollution load can be calculated with the user population for resident systems, while for non-resident systems there are various calculation methods. The correct determination of the number of users is important for the efficient operation of the pollution load and the treatment system (Yavaş, 2017). In addition to the aforementioned parameters, the design of natural wastewater treatment systems may change depending on the field characteristics, site restrictions, hydrological characteristics, climatic conditions, etc (Çakmakçı, et. al., 2013).

5. Conclusion

It is known that it is rapidly depleted of freshwater resources while factors such as industrialization, rapid urbanization and consumption, and population growth increase the demand for water day by day. For this reason, countries are developing measures for the use, protection, and efficient management of water resources due to the increased pressure on water resources. It is clear that the water demand will increase depending on the increasing percentage of the population and therefore the generation of wastewater will increase. For this reason, it is important to seek and develop safe solutions for the reuse or discharge of wastewater.

This chapter has reviewed the currently used applications of soil filters, stabilization ponds, constructed treatment wetlands, membranes,

pre-treatment systems, etc. for the natural treatment of wastewater. Moreover, it presents the applications, designs, advantages, and disadvantages of these systems.

Natural wastewater treatment systems are generally used in small settlements and places where there is no central sewer system. In these systems, soil, water, or wetlands emerge as a part of the wastewater treatment system. The design parameters of the systems can be affected by parameters such as existing field characteristics, wastewater characterization, and the number of users. However, if the systems are properly designed, they can provide a highly efficient reduction of pollutants in wastewater, either on their own or in two to three steps. Moreover, it can stand out with advantages such as being environmentally friendly, having low operating and maintenance costs, not needing technical personnel, not requiring much energy, and not requiring chemicals or spare equipment. But besides these advantages, there are also some disadvantages. These can be counted as the fact that the performance of the systems differs according to climate and environmental conditions, the treatment performance is affected due to the increase in the pollutant load or flow rate, they require a large area, etc. It is necessary to choose natural wastewater treatments with the most suitable solution and design and to construct them conveniently. Attention should be paid to the evaluation of the variables and treatment efficiency, meeting the operation and maintenance requirements if necessary, and the control of the receiving environment discharge criteria and the system. Systems should be chosen by adapting them to economic, social, and environmental activities.

6. References

- Anderson, D. L., & Siegrist, R. L. (1989). The Performance of Ultra-Low-Volume Flush Toilets in Phoenix. *Journal American Water Works Association*, 81(3), 52-57.
- Anlı, E. A., & Şanlı, T. (2019). Süt Endüstrisi Atık Sularının Arıtılmasında Aktif Çamur Prosesinin Kullanımı. *Akademik Gıda*, 17(2), 252-259.
- Aslan, M. (2016). Membran Teknolojileri. *T.C. Çevre ve Şehircilik Bakanlığı*, 286, Ankara.
- Ayaz, S. C., & Akca, I. (2000). Treatment of Wastewater by Constructed Wetland in Small Settlements. *Water Science and Technology*, 41(1), 69-72.
- Çakmakçı, M., Özkaya, B., Yetilmezsoy, K., & Demir, S. (2013). Su Arıtma Tesislerinin Tasarım ve İşletme Esasları. *T.C. Orman ve Su İşleri Bakanlığı, Su Yönetimi Genel Müdürlüğü*, 570s.
- Gray, N. F. (2021). *Natural Wastewater Treatment Systems and Sustainability*. World Scientific. 524 pages.
- Karpuzcu, M., Baykuş, N., & Yurtsever, A. (2020). An Experimental Study on Treatment of Domestic Wastewater By Natural Soil. *Engineering Sciences*, 15(4), 196-208.
- Keesstra, S. D., Geissen, V., Mosse, K., Piirinen, S., Scudiero, E., Leistra, M., & Van Schaik, L. (2012). Soil as a Filter for Groundwater Quality. *Current Opinion in Environmental Sustainability*, 4(5), 507-516.
- Koyun, H. (2020). Tekstil Endüstrisinde Membran Biyoreaktör Kullanımı ve Yenilikçi Yaklaşımlar. Bursa Teknik Üniversitesi, Mühendislik ve Doğa Bilimleri, Bitirme Tezi.
- Lavigne, R. L. (2005). Septic Systems. *Encyclopedia of Soils in the Environment*, 485-487. Doi:10.1016/b0-12-348530-4/00117-x.
- Mahmood, Q., Pervez, A., Zeb, S. B., Zaffar, H., Yaqoob, H., Waseem, M., etc. (2013). Natural Treatment Systems as Sustainable Ecotechnologies for the Developing Countries. *BioMed Research International*, Vol.2013, Article ID 796373, 19 pages.
- Mlejnská, E., & Rozkošný, M. (2016). Návrhové Parametry, Provozní Zkušenosti a Možnosti Intenzifikace Umělých Mokřadů. *Vodohospodářské technicko-ekonomické informace*, 58(2), 11-19.
- Muralikrishna, I. V., & Manickam, V. (2017). Wastewater Treatment Technologies. *Environmental Management*, 249-293. Doi:10.1016/b978-0-12-811989-1.00012-9.
- Nikolić, V., Milićević, D., Milenković, S., & Milivojević, A. (2010). Constructed Wetland Application in Wastewater Treatment Processes in Serbia. *BALWOIS*, Ohrid, 25-29.
- Omondi, D. O., & Navalía, A. C. (2020). Constructed Wetlands in Wastewater

Treatment and Challenges of Emerging Resistant Genes Filtration and Re-loading. *In Inland Waters-Dynamics and Ecology*, IntechOpen.

- Rajasulochana, P., & Preethy, V. (2016). Comparison on Efficiency of Various Techniques in Treatment of Waste and Sewage Water - A Comprehensive Review. *Resource-Efficient Technologies*, 2(4), 175-184.
- Rozkošný, M., Kriška, M., Šálek, J., Bodík, I. and Istenič, D. (2014). Natural Technologies of Wastewater Treatment. *Publisher: Global Water Partnership Central and Eastern Europe*, ISBN: 978-80-214-4831-5, Pages: 138p.
- Sato, T., Qadir, M., Yamamoto, S., Endo, T., & Zahoor, A. (2013). Global, Regional, and Country Level Need for Data on Wastewater Generation, Treatment, and Use. *Agricultural Water Management*, 130, 1-13.
- Seow, W. T., Lim, K. C., Nor, Md. H. M., Mubarak, M. F. M., Lam, Y. C., Yahya, A. and Ibrahim, Z. (2016). Review on Wastewater Treatment Technologies. *International Journal of Applied Environmental Sciences*, ISSN:0973-6077 Vol.11, Number 1(2016), 111-126.
- Stott, R., May, E., & Mara, D. D. (2003). Parasite Removal by Natural Wastewater Treatment Systems: Performance of Waste Stabilisation Ponds and Constructed Wetlands. *Water Science and Technology*, 48(2), 97-104.
- Url-1. (figure 2). T.C. Çevre ve Orman Bakanlığında: Atıksu Arıtma Tesisleri Teknik Usuller Tebliği. Resmî Gazete, 20 Mart 2010 Cumartesi, Sayı:27527, Ek-1. <https://www.resmigazete.gov.tr/eskiler/2010/03/20100320-7.htm>.
- Üçüncü, O. (2019). Atıksu Arıtımı, Atıksu Deşarjı, Su Kirliliği ve Halk Sağlığı: Trabzon İli Örneği. *Türk Hidrolik Dergisi*, 3(2), 14-29.
- Van Nieuwenhuijzen, A. F., Van der Graaf, J. H. J. M., & Mels, A. R. (2001). Direct Influent Filtration as A Pretreatment Step for More Sustainable Wastewater Treatment Systems. *Water Science and Technology*, 43(11), 91-98.
- Wang, Y., Yan, L., Li, J., Shen, H., Zhang, C., & Qu, T. (2016). A Review of Technology for Small Sewage Treatment: The Chinese Perspective. *Oxidation Communications*, 39(1), 275-284.
- WWAP (United Nations World Water Assessment Programme), (2017). *The United Nations World Water Development Report 2017. Wastewater: The Untapped Resource*. Paris, UNESCO.
- Yavaş, Ö. (2017). Doğal Atıksu arıtma Tesislerinin Verimliliğinin Değerlendirilmesi: Bursa İli Örneği. Bursa Uludag University, Master's Thesis, Turkey.
- Yazıcı, S. (2012). Elektrodializ Bipolar Membran Proseslerin Tıkanma Mekanizması ve Önleme Çalışmalarının Analizi: Sızıntı Suyu Örneği. Yıldız Teknik Üniversitesi, Fen Bilimleri Enstitüsü, Yüksek Lisans Tezi.
- Yıldız, S., Namal, O. Ö., & Çekim, M. (2013). Atık Su Arıtma Teknolojilerindeki Tarihsel Gelişimler. *Selçuk Üniversitesi Mühendislik, Bilim ve Teknoloji Dergisi*, 1(1), 55-67.
- Yigit, E. S. & Kayranli, B. (2022). Yapay Sulak Alan Atık Su Arıtma Sistemlerin

Evsel Atık Suların Arıtılmasında Kullanılmasında Karşılaşılan Sorunlar ve Öneriler. *Aksaray University Journal of Science and Engineering*, 6(1) (2022) 17-26.

Yinanç, A., & Adilođlu, S. (2017). Arıtmada Doğal Bitkilerin Kullanımı, Modeller ve Pilot Çalışma Örneđi: Kozan İlçesi. *Tekirdađ Ziraat Fakóltesi Dergisi*, 2017: 14(01).

Zacharia, A., Outwater, A. H., & Van Deun, R. (2020). Natural Wastewater Treatment Systems for Prevention and Control of Soil-Transmitted Helminths. *In Water Quality-Science, Assessments and Policy*, IntechOpen.

Zhang, Y., & Shen, Y. (2017). Wastewater Irrigation: Past, Present, and Future. *WIREs Water*, 2017, e1234. DOI: 10.1002/wat2.1234.

“

Chapter 9

**PRODUCING LIGHT CONCRETES BY
USING AGRICULTURAL WASTE OF
RICE**

Ayşe BICER¹, Nevin CELİK²

”

1 Doç. Dr. Turgut Ozal University, Department of Bioengineering, ayse.bicer@ozal.edu.tr

2 Prof. Dr. ,Firat University, Department of Mechanical Eng., nevincelik@firat.edu.tr

1. Introduction

Rice husk (RH) is the outer covering and husk that encloses the rice grain. RH is inedible and mostly needed in cosmetic products. Rice is generally included in the family of grasses, and is known as a grain that is most cultivated after wheat and corn production. In case of reuse of natural wastes, it is of great importance in terms of both economic and environmental concerns and the destruction of wastes in harmful substances created by industrial products. It is preferred to use resin or carbon in terms of eliminating metal substances in industrial wastewater and preventing harm to the environment. The RH is an important factor in removing these wastes.

RH is an ingredient that is used abundantly in cleaning products that are preferred in daily life. It is also possible to extract oil from the RH. Although this oil is of high quality, it can also be used in meals. The oil extracted from the RH is extremely beneficial to the skin. It provides skin repair, skin damage and softening the skin. RH oil meets the calorie requirement of the body according to its fat ratio. It has the feature of maintaining the balance of the body by reducing the amount of high urea and regulating high blood pressure. In addition, RH is good for diarrhea. You can boil the RH offered as a solution to diarrhea and drink the water. It contains plenty of vitamins and starch. At the same time, RH is known to be beneficial in the development of mental function as well as physical benefits. It is of great importance to people.

The RH is used in the iron and steel industry, especially in chicken farms, in cement production, rice production, fireworks. The rice shell contains carbon and silica. Since it contains these substances, it does not have a purpose such as nutrition. Another feature of the RH is that it is burned at high temperatures to form rice husk ash (RHA), and this ash is mixed with cement in a certain ratio and the tensile strength and pressure of concrete samples in bending are investigated.

The recently published researches show that, although the incorporation of RHA in building concrete has been increasing dramatically, the investigations related to the usage of RHA as the cement and RH as aggregate have not been held under microscope yet. This study seeks to fill the known analysis gap. Before introducing the study, a short blink to literature will be useful. First the recent researches about the study will be presented.

Sua-iam et al. (2019) used foundry sand waste as the fine aggregate and used untreated RHA instead of cement then produced a new concrete material. The tests applied on the produced samples showed that increasing the amount of waste sand and RHA in the mixture resulted with a low density and low slump flow loss. Moreover, mixing the waste sand and RHA

decreased the filling and passing ability of the new produced concrete.

Ameri et al. (2019) presented an optimization study in which the amounts of RHA and bacterial concentration in a self-compacting concrete. The RHA was used as the cement and micro-silica was used at a certain amount in the mixture. New concrete materials with low permeability and high strength were obtained as the result.

Adesina and Olutoge (2019) mixed the blended RHA and lime instead of conventional cement at different percentages. Since the lime enhances the pozzolanic reaction, the strength properties of the new produced RHA-Lime concrete increased.

Praveenkumar et al (2019) produced new concretes mixing the nanoparticles of Titanium dioxide and RHA as the replacement of cement. According to the test results, new material with the ratio of 10% RHA and 3% TiO_2 nanoparticles showed the highest strength and durability. However, increasing the TiO_2 Nanoparticles beyond 3% let the strength and durability decrease. Earlier than recent decade the subject was still popular. For example, Ling and Teo (2011) presented a comprehensive review article including the potential use of agricultural and industrial waste RHA for the production of light-weight concretes. In most papers that they cited the RHA was used as partial cement replacement in the mixtures. In most papers beside the thermal conductivity the tensile and compress strength tests were applied to the produced samples.

Sua-iam and Makul (2012) produced a new self-compacting concrete in which the RHA was used as the cement. Compressive strength and ultrasonic pulse velocity were applied on the new produced samples. As a conclusion, the optimum RHA replacement level was found to be 20% which had the best highest strength and lowest conductivity meanwhile.

Bahri et al. (2018) produced concrete samples including normal RHA, black RHA (namely BRHA), unground RHA, ground RHA, unground BRHA and ground BRHA for comparison. The applied tests show that the durability of concretes with unground RHA and ground RHA have higher values than that of the conventional concrete.

Sisman et al (2011) mixed RH aggregates into the concrete mixture, then tested the physical, mechanical and thermal properties of those new samples. The new samples have high resistance but low thermal conductivity. Chindaprasirt et al (2009) produced samples and then applied the tests of compressive strength, steel corrosion and chloride penetration depth. When the samples of with and without ground-RHA were compared, the compressive strength was found to be higher in the with ground-RHA than that of without ground-RHA sample.

Chao-Lung et al (2011) reported that when ground-RHA is used in the concrete mixture, it has a positive effect on the durability and strength of the new produced concrete. Chatveera and Lertwattanaruk (2011) determined that black RHA can increase the durability but decrease the shrinkage of the concrete. Ganesan et al (2008) showed that the presence of RHA in concrete can increase the compressive strength. Similarly, Ferraro and Nanni (2012) showed that, white RHA increases the corrosion resistance of the steel bar in the concrete.

From the cited papers from archival journals, it is definitely observed that a highly reactive pozzolanic which was due to small particle of RHA could improve the properties of concrete. Therefore, in this research, it is aimed to show the possible usage of all RH wastes either as the ash or as the aggregate, in the production of light concrete materials. Some important properties of those materials, such as thermal conductivity, density, compressive strength and tensile strength are measured with some tests. In addition to that, water absorptions tests, drilling, painting and screwing tests are applied to the produced samples.

2. Materials

2.1. Rice Husk (RH)

The rice or paddy (*Oryza sativa*) plant is an annual, monocotyledonous herb belonging to the Poaceae (Gramineae) family. *Oryza* rice varieties are grown for consumption and the seeds of the plants are collected. For the most part, rice is an annual herb. However, rarely, the rice plant grows as a perennial and can live for 10 years or more. The growing period (from seedling to harvest) of an annual rice plant varies between 95 days (early varieties) and approximately 250 days (late varieties). Medium early varieties can be harvested 120-150 days after sowing. Rice plant consists of root, stem, leaves and inflorescences. The root system length of the plant is from 25-30 cm to 100 cm. Rice seed is often called a grain. When the clusters are mature, each rice plant normally contains 50-60 or more than 120 grains. Grain consists of three main parts; endosperm containing husk, bran and embryo (Chindaprasirt et al., 2009).

The husk is removed from the grain in the husking stage of the rice mill. The RH has low moisture content, since the paddy is dried to 14% or less before milling. Some chemical analyses have been performed on a certain amount of RH in the laboratory and the weight ratios of (i) raw protein, (ii) major substances without nitrogen, (iii) raw cellulose, (iv) water and (v) ash amount is determined. The results of the chemical analysis of RH are presented in Table 1.

A well-supposed disadvantage of using RH is that; it has very low

density and therefore its transport over longer distance may cost quite expensive. The most obvious use of RH is so; the use as fuel at or close to the rice mill. The RHs are known as insulating materials, because they are hard to burn and less likely to allow moisture to propagate mold and fungi (Saraswathy and Song, 2007; Coutinho, 2003; Poon et al., 2006).

Some samples with the shape of flat plates are obtained from the RH by either molding and pressing the RH by the help of suitable adhesive glues, or mixing the RH with binders and then molding and belting. Besides, the RH can be used as filling materials between the walls without needing any process.

Table 1 Composition of the RH

Component	Raw protein	Major substances without nitrogen	Raw cellulose	Water	Ash
Weight ratio (%)	3.2	32.6	38.3	9.6	15.8

2.2. Rice Husk Ash (RHA)

Pozzolanic materials are the materials that are used to partially replace conventional Portland cement in concrete. They help to improve the quality and durability of the concrete. Likewise, the RHA, a residue ash that is obtained from the burning of RH has been used as a binder in the concrete (Chindaprasirt et al., 2009). The RHA is a highly reactive product and greatly improves the mechanical properties (Ameri et al., 2009; Sua-iam and Makul, 2012; Sisman et al, 2011; Saraswathy and Song, 2007) when added into a concrete mixture, also reduces chloride ion penetration (Parande et al, 2006) and water absorption (Coutinho, 2003; Poon et al., 2006; Yildirim et al, 1996). Detailed literature survey shows that, the RHA can improve either or both the strength and durability properties of the concrete (Ganesan et al, 2008; Parande et al, 2006; Bui et al, 2005; Chindaprasirt and Rukzon, 2008; Giaccio et al, 2007; de Sensale, 2006; Ramezani-pour et al, 2009; Bhanumathidas and Mehta, 2004; Saridemir, 2010).

The RHA is a carbon neutral green product. Some ways are found especially about disposing them by making commercial use of RHA. The RHA is also a good super-pozzolanic material. There is a growing demand for fine amorphous silica in the high performance concrete, high strength, low permeability concretes, bridges, marine environments and nuclear power plants etc. (Olmez and Heren, 1991).

If the burning process is incomplete, then carbonized-RH is produced. Depending on the energy conversion efficiency, the final product can be

either white RHA or black carbonized-RH. Fig. 1 shows some photos, in which the subfigures (a-c) respectively represent the unburned raw RH, RHA after burning and black carbonized-RH Chindapasirt, 2009).

The chemical analysis of RHA obtained after burning of RH is shown in Table 2. The table also shows the composition of Portland cement for better comparison.

Table 2 Chemical composition of the RHA

Comp. Strength	SiO ₂	Al ₂ O ₃	Fe ₂ O ₃	CaO	MgO	SO ₃	K ₂ O	N ₂ O	Loss of ignition	Undefined
RHA	92.5	0.5	0.22	0.23	0.85	0.45	2.27	0.59	1.99	-
Cement	18.65	6.15	3.25	56.4	2.34	2.9	0.7	-	2.84	6.75



a)



b)



c)

Fig. 1 Pictures of a) RH, b) RHA, c) carbonized-RHA

3. Experimental Study

Three major types of concretes are prepared by using RH and RHA in this study. All told samples are coded for reading facility. The codes and their definitions are listed in Table 3. In the first group of tests, the RH is used directly as an aggregate with cement-water mixture in the percentages of 60, 65 and 70% (samples: CI, CII, and CIII). In the second group, the concretes are produced by mixing cement, RH aggregates and water (Samples CBI, CBII, CBIII, and CBIV). Finally, the RHA is used as an additive in the third group (Samples: CAI, CAII, CAIII, CAIV, and CAV). These three groups of the concretes are molded into matrices of 10x10x10 cm dimension, in which RH or RHA are contained in amounts of 20, 30, 40 and 50 % of the total concrete volume.

A shotherm-QTM unit (Showa Denko), which runs according to the hot wire method of DIN 51046, is used to measure the thermal conductivities of the samples. Its range and sensitivity are respectively, 0.02-10 Wm⁻¹K⁻¹ and ± 5% (Saraswathy and Song, 2007; Bicer et al, 1992). Three locations are selected on each sample for the thermal conductivity measurements. The measurements are repeated 9 times. If a certain agreement is observed among the 9 measurements, that is, no big difference is seen in any of the repeated measurements, then the average of the 9 measurements is taken.

Mechanical strength tests are performed according to standard of ASTM C 109-80. Compressive strength and tensile strength tests are applied on each produced sample. Average values of at least 3 measurements are taken into consideration as the final value.

The last tests are the water absorption tests. The water absorption tests are especially important in terms of revealing the reaction of each sample against freezing. (Saraswathy and Song, 2007; Bicer et al, 1992). The critical amount of moisture is 30% of total dry volume, under which the material does not deform with freezing.

4. Results and Discussions

Attention now will be turned to the results of the tests. The test results of each sample will be presented by column-graphs and tables. However, before discussing on the results, the tested samples should be re-introduced with their codes. For reading facility of the text and graphs, the samples are coded with regard to their contents as previously mentioned as shown in Table 3.

4.1. Light Concretes with RH Aggregate

Using RH as an aggregate can produce light concretes. The chemical resistance of RH against decaying may be an advantage to realize this aim. Samples are prepared by directly mixing the RH with cement and water. In this experiment, three types of samples are prepared by three different mixtures as given in Table 3.

Table 3 Physical properties of the samples

Code	Definition	Volume of RH %	Water abs. %	RHA %	Water/ cement
CI	Light Concrete with RH aggregate	60	16.7	---	0.35
CII	Light Concrete with RH aggregate	65	18.8	---	0.5
CIII	Light Concrete with RH aggregate	70	21.2	---	0.65
CBI	Light Concrete with RH	0	3.3	---	0.6
CBII	Light Concrete with RH	20	36.7	---	0.6
CBIII	Light Concrete with RH	30	48.5	---	0.6
CBIV	Light Concrete with RH	50	54.1	---	0.6
CAI	Concrete with RHA	---	6.83	0	0.5
CAII	Concrete with RHA	---	5.9	5	0.5
CAIII	Concrete with RHA	---	5.43	10	0.5
CAIV	Concrete with RHA	---	4.95	15	0.5
CAV	Concrete with RHA	---	5.1	20	0.5

Before preparing the samples of concretes with RH aggregate, the RH is wetted to be saturated. The amount of water in the mixture is constant, but RH percent and water-cement ratio (W/C) are changed in each sample. The results of the tests conducted on 28-days-aged concrete samples are presented in Fig. 2.

The thermal conductivity of the concrete with RH shows that it may be used for heat and sound insulation in buildings. On the other hand, the found-out strength values showed that, it cannot be used as load carrier. It has good adhesive property. It cannot be applied as plaster but can easily adapt plastering. It is suitable to be used as a filling material because of its weight. The cases where the RH concrete can be used in the buildings are summarized as below:

- Ferro-concrete flat roofs and flat proofs
- Insulation material in ceiling and laying floor
- Filling material in wooden floor

It was seen that concretes with RH can easily adapt to plaster and that cannot be deformed even after a long time. It has not shown any sign of ignition even when 3 cm thick sample is tested in fire for half an hour.

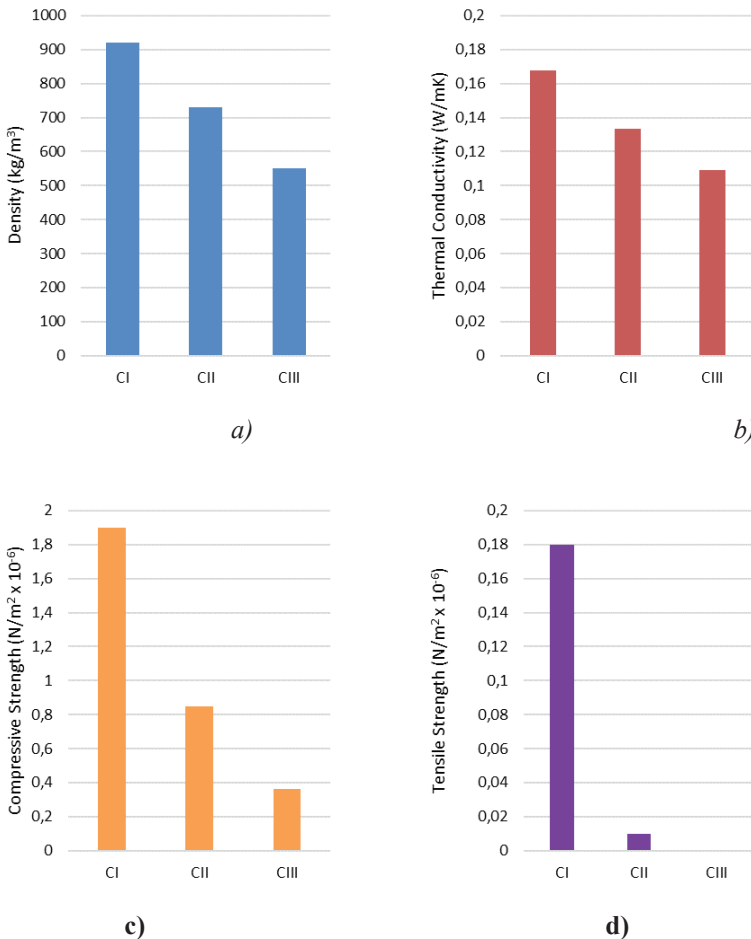

Fig. 2 Physical properties of the concretes with RH aggregate a) Density, b) Thermal conductivity, c) Compressive strength, d) Tensile strength

4.2. Light Concretes with RH

Samples containing RH in 20, 30 and 50% of concrete volume are prepared. Natural aggregate of $d_{max} = 4.76$ mm grain diameter is used as aggregate. The ratio of $W/C = 0.6$ was constant in each sample. The results of the tests made on the 28-days-aged concrete samples are given in Fig. 3.

By these results it is shown that there is an opportunity of using RH with aggregates in light concrete which has a relatively load carrier property.

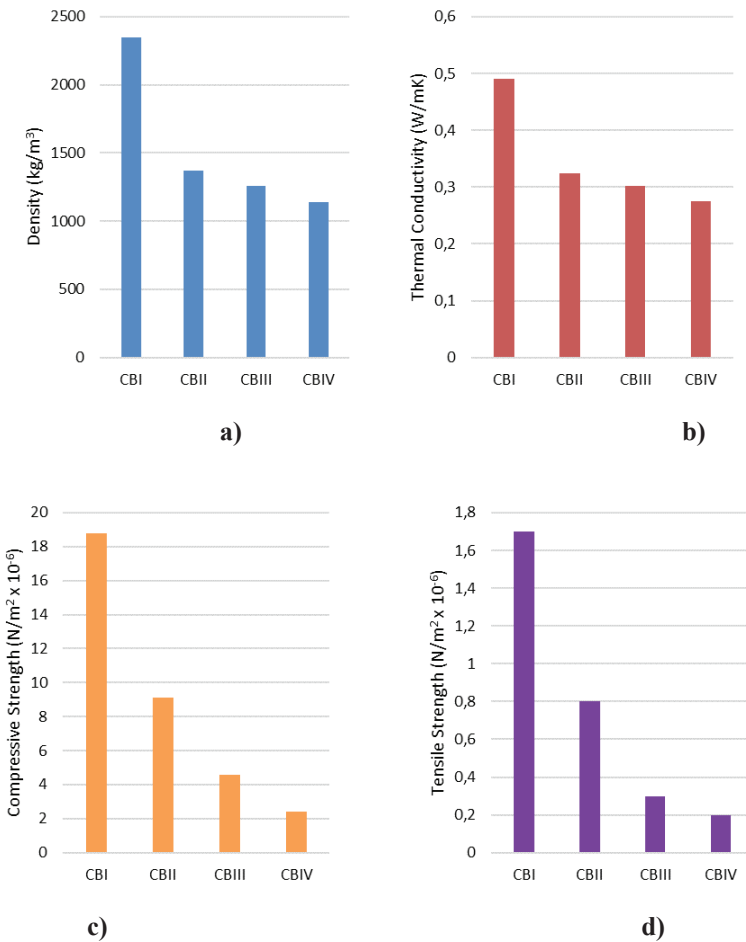

Fig. 3 Properties of light concrete with RH, a) Density, b) Thermal conductivity, c) Compressive strength, d) Tensile strength

4.3. Concretes with RHA

The RH is burned at 450-1000 °C temperature range in order to utilize its ash as a structural material. Chemical analysis of the RHA formed after complete combustion is already listed in Table 2. Various mixtures are prepared by using RHA as an additive, in the proportions of 5, 10, 15 and 20 % of the cement weight and $W/C = 0.50$ (Table 3). After ageing the samples during 28 days, the tests are performed. The results are shown in Fig. 4.

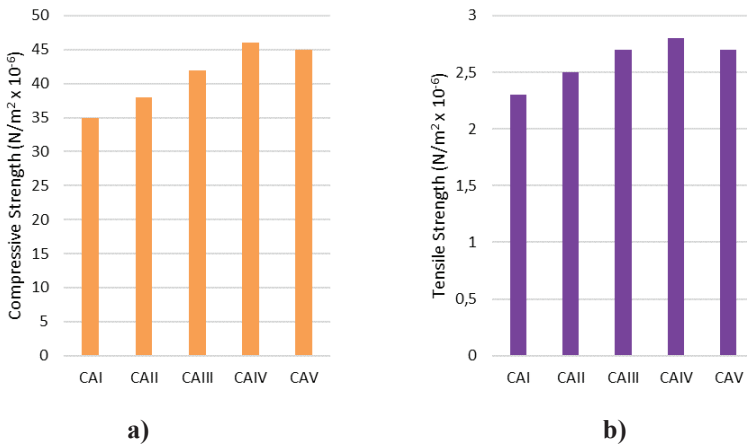

Fig. 4 a) Compressive and b) Tensile strengths of the concretes with RHA

5. Conclusions

In this study, the effects of RH and RHA on the concrete are investigated. The results of the experiments showed that the conductivity of the concretes with RH is very low. For this reason, it is possible to use it as an insulation material in ceilings, roofs, floors and walls. But it is not suitable to be used in places, which directly contact to water, due to the tendency to absorb a high amount of water. It must not be used, however, as a major carrying material due to its low compressive strength.

The RHA produced by burning RH is very rich in SiO_2 . This may be considered as an advantage for ash to be used as a pozzolanic material. The strength of concretes increases when RHA is used as an additive material. Compressive strength, tensile strength and water absorption capacity of concretes increase when RHA is added up to the ratio of 15%. It is possible to use concretes with RHA as a carrying material to overcome high bending and compressive loads. It is seen that the RHA can also be used in damp places, because of low water absorbent property.

References

- Adesina, P.A., Olutoge, F.A. (2019). Structural Properties of Sustainable Concrete Developed Using Rice Husk Ash and Hydrated Lime. *Journal of Building Engineering*, 25, Article Number 100804.
- Ameri, F., Shoaee, P., Bahrami, N., Vaezi, M., Ozbakkaloglu, T. (2019). Optimum Rice Husk Ash Content and Bacterial Concentration in Self-Compacting Concrete. *Construction and Building Materials*, 222, 796-813.
- Bahri, S., Mahmud, H.B., Shafiq, P. (2018). Effect of Utilizing Unground and Ground Normal and Black Rice Husk Ash on the Mechanical and Durability Properties of High-Strength Concrete. *Sadhana - Academy Proceedings in Engineering Sciences*, 43(22), 1-12.
- Bhanumathidas, N., Mehta, P.K. (2004). Concrete Mixtures Made with Ternary Blended Cements Containing Fly Ash and Rice Husk Ash. in: Malhotra V.M., editor. *International Conference Proceeding of 7th CANMET Chennai*, India, 199(22), 379-91.
- Bicer, Y., Pihtili, K., Ayhan, T. (1992). An Investigation on the Heat Insulation Plaster Including Fly Ash of Thermal Power Stations. *Journal of Thermal Sciences and Technology*, 15(3), 24-29.
- Bui, D.D., Hu, J., Stroeven, P. (2005). Particle Size Effect on the Strength of Rice Husk Ash Blended Gap-Graded Portland Cement Concrete. *Cement & Concrete Composites*, 27(3), 357-366.
- Chao-Lung, H., Anh-Tuan, B.L., Chun-Tsun, C. (2011). Effect of Rice Husk Ash on the Strength and Durability Characteristics of Concrete. *Construction and Building Materials*, 25(9), 3768-3772.
- Chatveera, B., Lertwattanaruk, P. (2011). Durability of Conventional Concretes Containing Black Rice Husk Ash. *Journal of Environmental Management*, 92 (1), 59-66
- Chindaprasirt, P., Rukzon, S. (2008). Strength, Porosity and Corrosion Resistance of Ternary Blend Portland Cement, Rice Husk Ash and Fly Ash Mortar. *Construction and Building Materials*, 22(8),1601-1606.
- Chindaprasirt, P., Jaturapitakkul, C., Rattanasak, U. (2009). Influence of Fineness of Rice Husk Ash and Additives on the Properties of Lightweight Aggregate. *Fuel*, 88(1), 158-162.
- Coutinho, J.S. (2003). The Combined Benefits of CPF and RHA in Improving the Durability of Concrete Structures. *Cement & Concrete Composites*, 25, 51-59.
- de Sensale, G.R. (2006). Strength Development of Concrete with Rice-Husk Ash. *Cement & Concrete Composites*, 28(2),158-160.
- Ferraro, R.M., Nanni, A. (2012). Effect of off-White Rice Husk Ash on Strength, Porosity, Conductivity and Corrosion Resistance of White Concrete. *Con-*

struction and Building Materials, 31, 220-225.

- Ganesan, K., Rajagopal, K., Thangavel, K. (2008). Rice Husk Ash Blended Cement: Assessment of Optimal Level of Replacement for Strength and Permeability Properties of Concrete. *Construction and Building Materials*, 22 (8), 1675-1683.
- Giaccio, G., de Sensale, G.R., Zerbino, R. (2007). Failure Mechanism of Normal and High-Strength Concrete With Rice-Husk Ash. *Cement & Concrete Composites*, 29(7), 566–574.
- Ling, I.H., Teo, D.C.L., (2011). Lightweight Concrete Bricks Produced from Industrial and Agricultural Solid Waste. *World Congress on Sustainable Technologies*, 6114213, 148-152.
- Olmez, H., Heren, Z. (1991). The Production of Pozzolanic Rice Husk Ash and the Behavior of Rice Husk Cement Pastes. *Doga Turkish Journal of Chemistry*, 15, 9-15
- Parande, A.K., Babu, B.R., Karthik, M.A., Kumaar, K.K.D., Palaniswamy, N. (2006). Study on Strength and Corrosion Performance for Steel Embedded in Metakaolin Blended Concrete/Mortar. *Construction and Building Materials*, 20(10), 858–865.
- Poon, C.S., Kou, S.C., Lam, L. (2006). Compressive Strength, Chloride Diffusivity and Pore Structure of High Performance Metakaolin and Silica Fume Concrete. *Construction and Building Materials*, 20(10), 858–865.
- Praveenkumar, T.R., Vijayalakshmi, M.M., Meddah, M.S. (2019). Strengths and Durability Performances of Blended Cement Concrete with TiO₂ Nanoparticles and Rice Husk Ash. *Construction and Building Materials*, 217, 343-351.
- Ramezaniapour, A.A., Mahdikhani, M. Ahmadibeni, G. (2009). The Effect of Rice Husk Ash on Mechanical Properties and Durability of Sustainable Concretes. *International Journal of Civil Engineering*, 7(2), 83–91.
- Saraswathy, V., Song, H.W. (2007). Corrosion Performance of Rice Husk Ash Blended Concrete. *Construction and Building Materials*, 21, 1779–1784.
- Saridemir, M. (2010). Genetic Programming Approach for Prediction of Compressive Strength of Concretes Containing Rice Husk Ash. *Construction and Building Materials*, 24,1911–1919.
- Sisman, C.B., Gezer, E., Kocaman, I. (2011). Effects of Organic Waste (Rice Husk) on the Concrete Properties for Farm Buildings. *Bulgarian Journal of Agricultural Science*, 17, 40-48.
- Sua-iam, G., Makul, N. (2012). The Use of Residual Rice Husk Ash from Thermal Power Plant as Cement Replacement Material in Producing Self-Compacting Concrete. *Advanced Materials Research*, 415, 1490-1495.
- Sua-iam, G., Makul, N., Cheng, S., Sokrai, P. (2019). Workability and Compressive Strength Development of Self-Consolidating Concrete Incorporating

Rice Husk Ash and Foundry Sand Waste – A Preliminary Experimental Study. *Construction and Building Materials*, 228, 116813.

Yildirim, S., Bicer, Y., Yildiz, C. (1996). Utilization of Fly Ash and Polypropylene Wastes in the Production of A New Porous Composite Material. *Journal of Porous Materials*, 3, 189-191.

“

Chapter 10

**AN OVERVIEW OF MICROWAVE
NONDESTRUCTIVE TESTING (NDT)
METHOD**

Ali Recai ÇELİK¹

”

¹ Dr., Dicle Ün. Elektrik-Elektronik Müh. Bölümü E-mail: ecealicelik@gmail.com

Introduction

Detection methods applied in order to obtain information about the properties and structures of materials without damaging them are generally called non-destructive testing (NDT). In these methods, since it is not necessary to take samples from the materials, the evaluation of the entire substance can be performed. There are various types of NDT, depending on the type of materials being tested, and the desired properties to be examined. Some of these evaluations are Penetrant Fluid, Eddy Currents, Magnetic Particles, Ultrasound Waves, X-Rays, and Microwaves NDT (Haryono and Abou Khoua, 2020; Reddy, 2017; Hamia et al., 2014). Each method has positive aspects as well as shortcomings. Therefore, the methods are often used as complementary to each other.

In this study, the Microwave NDT method was examined. For this purpose, first of all, general information about microwaves was given. Then, the working principle of this method was explained, and its advantages and disadvantages were mentioned. After that, some studies in the literature on Microwave NDT were reviewed and discussed. By sharing the findings obtained in those studies, the state and importance of using microwaves in harmless testing, detection and evaluation process were emphasized. Finally, the study was summarized and concluded.

Microwaves

Electromagnetic waves with frequencies ranging 300 MHz - 300 GHz (1 m to 1 mm in wavelength) are named ‘microwaves’ as given in Figure 1 (Mpoweruk, 2022).

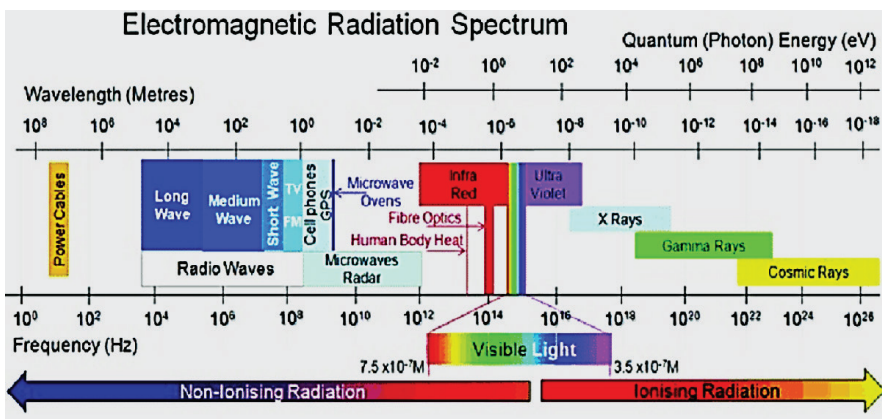

Figure 1. Electromagnetic radiation spectrum (Mpoweruk, 2022)

Microwaves are widely used in households, communication systems, biomedical applications, industrial area, and nondestructive evaluations as mentioned above. They are generally typed to their frequency ranges as VHF, L, S, C, X, Ku and K bands as seen in Table 1 (Veley, 1987). Microwave signals have the ability to easily penetrate the electrically insulating (dielectric) materials. The depth of penetration depends on the ability of the dielectric material to absorb microwave energy and the wavelength of the signal used. The use of microwaves is based on the principle of sending electromagnetic energies to matter in waves. Then, the parts of the wave that pass through the material and are reflected are measured.

Table 1. Microwave Frequency Bands

Frequency	Microwave Band
100-1000 MHz	VHF
1-2 GHz	L
2-4 GHz	S
4-8 GHz	C
8-12.4 GHz	X
12.4-18 GHz	Ku
18-26.5 GHz	K

Microwave NDT

When an electromagnetic wave passes from one medium to another medium, some of the waves pass to the second medium and some are reflected back as seen in Figure 2 (Celik, 2018). The reflection coefficient (Γ) is calculated to find the amount of the reflected wave, and the transmission coefficient (T) is calculated to find the amount of the transmitted wave by using Maxwell's Equations. By interpreting these wave quantities, information about the various properties of the examined substance can be obtained.

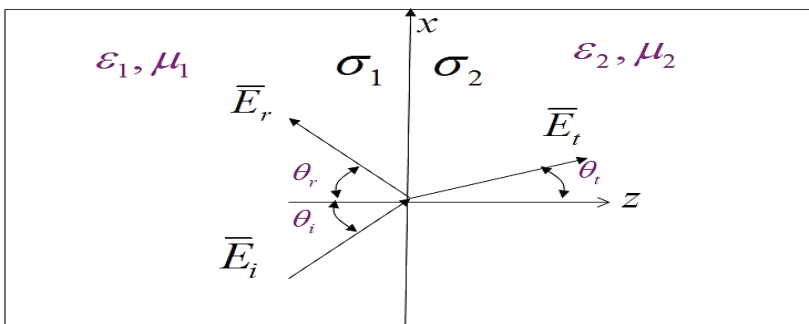

Figure 2. Transition of an electromagnetic wave to a different medium

Microwave NDT method can be used to measure near and far field distance, determine the dimensions of objects, evaluate the characteristics of substances, detect cracks in concrete and metals, and perform microwave imaging. Some advantages of using microwaves in NDT are summarized below:

- The thickness of dielectric composites coated with materials such as plastic, ceramic etc. can be measured precisely.
- Abnormal conditions such as breakage, distortion, decomposition, etc. can be detected quickly and reliable.
- Information about the internal structures of materials such as moisture rate, porosity etc. can be determined successfully.
- The characteristic properties of materials are not affected by the measurements.
- The material being tested does not contact with the measuring device. Therefore, simultaneous measurements can be made.
- It is a time and cost saving method.

NDT has a few disadvantages besides the advantages given above and therefore minor problems may arise. For example; some components need to be cleaned before and after inspection, some measurements may be affected by magnetic permeability, the precision of measurements may be affected by the coating of objects, only non-porous surfaces can be examined in some NDT measurements, and some tests may only be effective on materials that are conductive (Sobkiewicz et al., 2021).

Some Studies Related With the Microwave NDT

There are many areas using the Microwave NDT such as measurement of the concrete dielectric properties, measurement of the moisture contents, determination of the fruit ripening conditions, evaluation of the food qualities, detection of the surface cracks, and biomedical imaging. In this section, some studies on these issues are briefly shared.

Measurement of the Concrete Dielectric Properties

The concrete dielectric properties are important parameters providing the detection of concrete deterioration. In the study of (Jamil et al., 2013), some properties such as transmission and reflection coefficients, relative permittivities, and loss factors of various concretes were experimentally investigated using the Microwave NDT method.

Microwaves in the range of 7.0 GHz to 13.0 GHz were preferred for the measurements. According to the results of that study, this method showed a good correlation to determine the compressive strength and wa-

ter-to-cement (w/c) ratio of the concrete. In addition, it was emphasized that the NDT technique can be used to determine the fiber distribution and concentration in steel fiber-reinforced concrete.

In another study, the reflectance and transmittance properties of the cement-based samples were examined in the X band. It has been explained that the reflection and transmission coefficients can be used to detect the permittivity of cement-based materials. Due to the porosity present in the samples, it was shown that a higher transmission coefficient corresponds to the higher initial w/c ratio of the hardened samples. According to the measurements, a simple and inexpensive measuring setup can monitor cement-based sample properties at almost all stages by using Microwave NDT (Kharkovsky et al., 2002).

Measurement of the Moisture Contents

According to the general principle of the Microwave NDT, moisture measurements can be carried out in two ways. The first is to measure the microwave power reflected from the material, and the second is to measure the microwave power passing it. In a respected study in which this principle was applied, a microwave system that had potentially capable of providing production-line inspection of structural lumber was described. In the study, it was explained that the dielectric properties of wood are especially related to moisture content and density of the wood. In addition to the moisture and density, the grain direction of the wood was also measured. In the measurements, microwaves at 4.8 GHz were preferred, and an accurate estimate for the dielectric tensor of the medium was provided (James et al., 1985).

In another recent study, a microwave NDT moisture determination system was set up using a coaxial surface probe at 1.7 GHz to determine the moisture content of a concrete sample. According to the measurement results, larger resonance frequency shifts were observed at higher moisture content levels. Therefore, it was determined that there is a direct correlation between the changes in the resonance frequency shift and the moisture content variations. It was explained that thanks to the NDT, the moisture content of structures can be evaluated even after the construction of a building has been completed (Olkkonen, 2017).

Determination of the Fruit Ripening Conditions

Since NDT techniques are harmless, environmentally friendly, reliable and simple, they can be used for rapid evaluation of the fruit maturity stages. One of the important techniques using for this aim is Microwave NDT as mentioned before. However, the application of this method for fruits is still in its infancy.

In one of the few studies on this subject, it was emphasized that some fruits may not have the required juiciness even if they reach the maturity color. It was explained that microwaves can pass through fruit tissue, however, they can be blocked with water. Hence, the level of maturity can be predicted by measuring water content rather than by color observation, and Microwave NDT can provide an alternative technology to evaluate ripening (Hussain et al., 2018).

In another study, it was mentioned that fruits containing granules were generally not considered suitable for sale. For this reason, it was stated that moisture changes in fruits should be monitored in order to detect granule formation. For this aim, the real and complex permittivity of the grapefruits in the frequency range of 1–10 GHz were examined. It was observed that measurements using the microwave split ring resonator (SRR) sensor were able to differentiate various time points during the aging of the fruit. The method used in that study was suitable for quick and first-quality checks of fruit maturity (Redzwan et al., 2018). Experimental measurements were made on three different regions such as the surface of the peel, 0.5 cm inside the peel and the inner flesh of the fruit. The dielectric characterization was done using a network analyzer. Complex permittivity was measured using a long open-ended coaxial probe as shown in Figure 3.

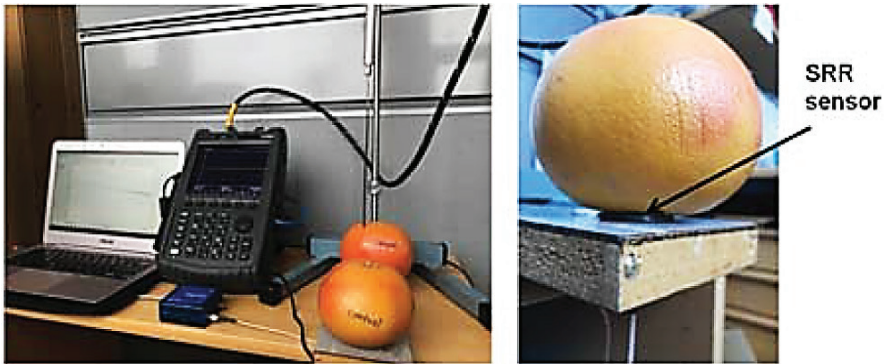

Figure 3. *An image of the experiment made in (Redzwan et al., 2018).*

Evaluation of the Food Qualities

Microwave NDT can be used to assess several quality parameters in distribution and retail to prepare food. Some measurements were done in (Qi et al., 2017) to observe the reliability in detecting foreign objects and show the capability of this method to measure fat content in minced meat. In another study, the Microwave NDT method at frequencies 8 GHz to 12 GHz was applied to investigate the S-parameters of Canola, Palm, and

olive oils. It was explained that this method offers advantages over other methods thanks to its high resolution and contactless properties (Hilmi et al., 2021).

Detection of the Surface Cracks

Because cracks in concrete pose a great threat to structures, they are very dangerous and can cause damage. Microwave NDT method can be used for early detection of these cracks. In the study of (Jiya et al., 2017), an ultra-wideband microwave imaging (MI) technique was suggested for this purpose. According to the simulation and experimental results, cracks with a size of 5 mm were detected with a resolution of $\lambda/14$. Accordingly, using microwaves was proven to have a high potential to detect defects in cement-based structures.

In another paper, a simple MI probe with a very high resolution ($\lambda/308$) around 390 MHz was proposed. This probe could determine a 0.5 mm width crack via non-metal materials, and a 0.2 mm width crack via metal materials. It was explained that the proposed probe was well suited to the sensor array, thanks to its simple planar construction without any redundant matching circuits (Xie et al., 2020). The measurement setup of that study can be seen in Figure 4.

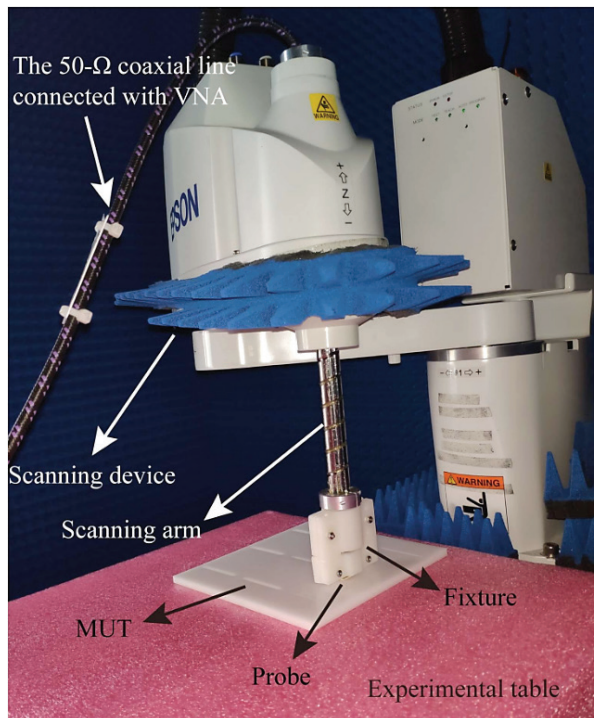

Figure 4. An image of the measurement setup used in (Xie et al., 2020)

Biomedical Imaging

Many studies have been done in recent years for the detection of breast, brain, and lung tumors by using microwaves. The results of three separate studies will be mentioned in this section for different types of cancer. Some experimental measurements for a microwave breast tumor detection system were made in (Celik et al., 2019). A compact-sized ultra-wideband sensor was used in the experiments. Different breast phantoms were formed as target materials for the setup. A 6 mm object which had similar electrical properties to the tumor was detected in both frequency and time domain measurements. It was concluded that the presence, size, and position of the tumor could be clearly determined using microwave NDT.

Another study was conducted to determine the brain tumors in their early stages. For this aim, 16 antennas that can operate in the 1–4 GHz frequency range were designed for use in the multi-static measurement setup, and successful results were obtained in that study (Mohammed, 2014). Another multi-static measurement system was set up for the detection of lung cancer in (Zamani et al., 2015). In the system, antennas operating at frequencies of 1.5–3 GHz were preferred. A phantom representing the human body was created. The obtained results confirmed the reliability of the used measurement technique in lung cancer detection.

Conclusions

Since microwaves have nonionizing radiation, they can be used confidently in many areas. Radar applications, communication systems, internet applications, security systems, and microwave ovens are some of the areas of use. Besides these, microwaves have also been used to detect and evaluate the properties of materials in recent years. This harmless detection method is named NDT, and if microwaves are used in the method, it is called Microwave NDT. In this chapter, the features of this method were explained, and its merits and drawbacks were discussed. Some studies in which the Microwave NDT was used such as measurement of the concrete dielectric properties, measurement of the moisture contents, determination of the fruit ripening conditions, evaluation of the food qualities, detection of the surface cracks, and biomedical imaging were reviewed. Finally, it was concluded that Microwave NDT is an alternative method having great potential to test and evaluate the characteristic of various materials.

REFERENCES

- Reddy, K. A. (2017). Non-destructive testing evaluation of stainless steel materials. *Mater. Today Proc.*, 4(8), 7302–7312.
- Hamia, R., Cordier, C. & Dolabdjian, C. (2014). Eddy-current non-destructive testing system for the determination of crack orientation. *NDT E Int.*, 61, 24–28.
- Haryono, A. & Abou-Khousa, M.A. (2020). Microwave non-destructive evaluation of glass reinforced epoxy and high density polyethylene pipes. *Journal of Nondestructive Evaluation*, 39(1), 1–9.
- <https://www.mpoweruk.com/radio.htm> Access: December, 2022.
- Veley, V.F. (1987). Modern Microwave Technology, Chapter (1), *Ellis Horwood Limited*, New York.
- Celik A.R. (2018). Detection of the breast tumors by ultra-wideband radar based microwave method. *Ph.D. Thesis*, Dicle University, Diyarbakir, Turkey.
- Sobkiewicz P., Bienkowski P. & Błażejowski W. (2021). Microwave non-destructive testing for delamination detection in layered composite pipelines. *Sensors*, 21(12), 4168. doi:10.3390/s21124168
- Jamil, M., Hassan, M.K., Al-Mattarneh, H.M.A. et al. (2013). Concrete dielectric properties investigation using microwave nondestructive techniques. *Master Struct* 46, 77–87.
- Kharkovsky, S. N., Akay, M. F., Hasar, U. C. & Atis, C. D. (2002). Measurement and monitoring of microwave reflection and transmission properties of cement-based specimens. *IEEE Transactions on Instrumentation and Measurement*, 51,6, 1210-1218.
- James, W.L., Yen, Y.H. & King, R.J. (1985). A microwave method for measuring moisture content, density and grain angle of wood. *US Department of Agric. Forest Service; FPL-0250*.
- Olkkonen, M.K. (2017). Feasibility Study of moisture measurement of a concrete pavement tile employing a 1.7 GHz coaxial surface probe, *Nordic Concrete*, 25.
- Hussain, A., Pu, H. & Sun, D.W. (2018). Innovative nondestructive imaging techniques for ripening and maturity of fruits—a review of recent applications. *Trends Food Sci. Technol.*, 72, 144–152.
- Redzwan, S., Perez, M.D., Velandar, J. & Augustine, R. (2018). Study of maturity fruit assessment using permittivity and microwave reflectivity measurements for quality classification. *IEEE Conference on Antenna Measurements & Applications (CAMA)*, 1–3.
- Qi, S., Ren, J., Gu, L., Xu, H., & Wang, Y. (2017). The application research of microwave nondestructive testing and imaging based on ω -k algorithm. *Ninth International Conference on Digital Image Processing (ICDIP 2017)*, 661.

- Hilmi, N.A.M., Khan, Z.I., Rashid, N.E.A. et al. (2021). Parametric evaluation of edible oils using microwave non-destructive testing (MNDT) in X band frequency. *IEEE Symposium on Wireless Technology & Applications (ISW-TA 2021)*, 97–102.
- Jiya, E.A., Anwar, N.S.N. & Abdullah, M. Z. (2016). Detection of cracks in concrete structure using microwave imaging technique, *International Journal of Microwave Science and Technology*, Article ID:3195716, 6.
- Xie, Z., Li, Y., Sun, L. et al. (2020) A simple high-resolution near-field probe for microwave non-destructive test and imaging. *Sensors*, 20, 2670.
- Celik, A.R., Kurt, M.B. & Helhel, S. (2019). An experimental performance investigation of an ultra-wideband directional antenna in the microwave imaging of breast cancer tumor. *Applied Computational Electromagnetics Society (ACES) Journal*, 34(10), 549–559.
- Mohammed, B.J. (2014). Design and implementation of microwave imaging systems for medical applications, *Ph.D. Thesis*, The University of Queensland School of Information Technology and Electrical Engineering, Australia.
- Zamani, A., Rezaeieh, S.A. & Abbosh, A.M. (2015). Lung cancer detection using frequency-domain microwave imaging, *Electron. Lett.*, 51(10), 740–741.

“

Chapter 11

**INVESTIGATION OF RAINWATER
HARVESTING IN A FACTORY LOCATED
IN KÜTAHYA-TURKEY**

İlker KILIÇ¹

”

¹ Prof. Dr., Bursa Uludag University, Faculty of Agriculture, Department of Biosystems Engineering, ikilic@uludag.edu.tr

1. INTRODUCTION

In recent years, the need for water has increased due to global warming, climate change, and drought. Of the 1.4 billion km³ of water available in the world, 97% is salt water and the remaining 2.5% is fresh water in rivers and lakes. It is understood that the amount of freshwater that can be utilized is extremely limited since more than 90% of this freshwater is found at the poles and underground [1]. In addition, due to the uneven distribution of existing water resources in the world, many countries suffer from water shortages. It is reported by the World Water Resources Institute that many countries, including our country, may face the problem of water scarcity after about 15-20 years [2]. In fact, according to the World Water Development (UN) Report, it has been estimated that 50% of the world's population will be under high water scarcity in 2050 [3]. While the world population has tripled in the last century, the demand for water resources has increased sevenfold [4]. Therefore, contamination of available accessible water resources should be prevented. This situation necessitates the widespread use of wastewater treatment technologies and the necessary treatment of wastewater. In addition, studies should be conducted on alternative water resources, seawater purification, water harvesting, reuse of treated wastewater, and transfer of water between basins and virtual water.

Rainwater harvesting, which is among the low-cost alternatives, is one of the environmentally friendly methods of obtaining water that has attracted attention in recent years. Harvested rainwater can be used in many different areas for purposes such as irrigation of green areas, use in sinks, and car washing, in addition to the drinking water supply. The use of rainwater harvesting systems in buildings with large roof areas such as factories, shopping malls, hospitals, stadiums, and airports provides great advantages. A schematic representation of rainwater harvesting is shown in Figure 1 [5].

In this study, the amount of rainwater that can be collected from the roof of a factory producing ceramics in Kütahya was calculated. As a result of the calculations, it has been determined that 17211.3 m³ of rainwater can be harvested annually with the system to be established.

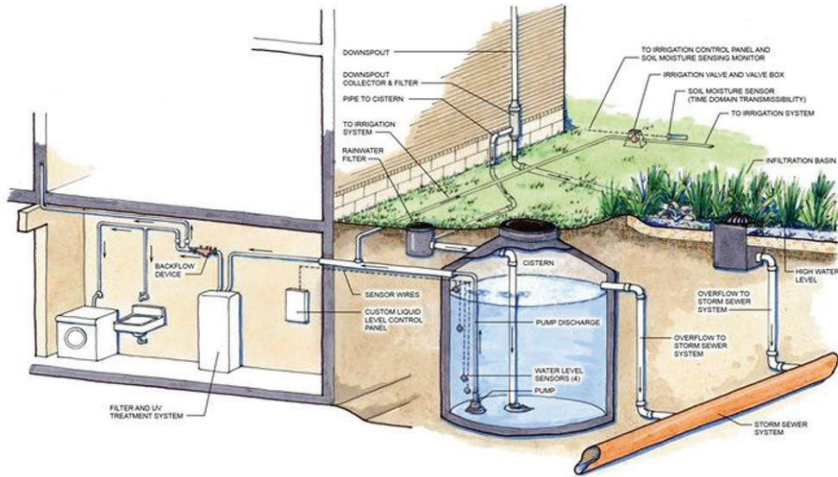

Figure 1. *A Schematic Representation of Rainwater Harvesting*

2. RAINWATER HARVESTING METHODS

Rainwater harvesting techniques are examined in four groups. These are water harvesting from the roof surface, micro-basin water harvesting, macro-basin water harvesting, and flood harvesting.

2.1. Water Harvesting From the Roof Surface

Rainwater coming to the roof surface is transferred to a tank on the soil surface or to the underground storage made of reinforced concrete, fiberglass, or stainless steel via gutters. In this method, 80-85% of precipitation can be collected. The water collected from the roof surface can be used in the washing machine and toilet reservoir inside the building, and outside the building for garden irrigation, car washing, and filling the ornamental pool [6, 7].

2.2. Micro-Basin Water Harvesting

In the micro-basin water harvesting method used in small green areas, afforestation areas, and orchards, the runoff on the soil surface is collected. The runoff and the cultivation area are adjacent to each other, and the water is stored in the root zone of the plant. In this method, no precautions are taken for excess water [8, 9].

2.3. Macro-Basin Water Harvesting

In this method where the runoff on the soil surface is collected, there is a large basin outside the cultivation area. Measures can be taken to increase the surface flow coefficient of the basin area. The collected water is accumulated in the soil and excess water is removed. The slope of the basin

area is between 5-50%. The planted area is terraced or flat land (<10%). The method is applied where the annual precipitation is more than 300 mm [6].

2.4. Flood Harvesting

Excess water is removed by the collection of irregular seasonal stream flow and stored in the pond, reservoir area, or soil. This harvesting method reduces the damage caused by sudden floods and provides soil moisture and groundwater supply needed for plant production. If storage is to be done in this method, which is applied in regions where the annual precipitation is higher than 300 mm, this value should be 150 mm/year or higher [6].

Flood water finds use for afforestation in many parts of the world, especially in arid areas. This method involves systems requiring complex dams and distribution networks, an area of many kilometers where runoff occurs in a large valley. Flood harvesting techniques have been practiced for thousands of years, and today these systems are used in Mexico, Pakistan, Tunisia, Kenya, China, etc. used in countries [10].

3. LITERATURE REVIEW

There are many studies in the literature on rainwater harvesting systems. These studies have been focused on universities [11, 12], schools [13], shopping malls [10, 14], rural areas [15, 16], airports [17, 18], tennis courts [19], stadiums [20], factories [21, 22].

The rainwater harvesting system was applied to tennis courts in Portugal by Pimentel-Rodrigues and Silva-Afonso [18] and the water consumption was reduced by more than 50%. The payback period of the system was calculated as 11.9 years. In another rainwater harvesting study done in an elementary school in Washington D.C., the USA, an 85% reduction in water use was obtained [23]. Rainwater harvesting was studied at Mersin University by Yiğit et al. [24], and 59,151 m³ of rainwater was collected from the roofs in a year. It has been found that the collected rainwater could be saved 46% if the water is used for irrigation regularly. Sahu and Verma [25] collected rainwater from Swami Vivekananda Airport, India, which has a 38,955.62 m² rooftop area and this amount was on average 30% of the total daily demand of the airport. Nyatuame and Atigah [26] conducted to evaluate the potential of a rainwater harvesting system for a hospital located in Ghana. The harvested rainwater amount was 53,524.29 m³ per year when the monthly and yearly demand of water for the hospital was 3,146 m³ and 337,752 m³ respectively. The collected rainwater meets the water needs of the hospital.

4. MATERIALS AND METHODS

The factory, which produces porcelain, ceramics, stone, and earth-based industrial products in Kütahya, consists of 5 floors and employs 3000 people. There is also an administrative building outside the factory. Within the scope of the study, it is aimed that the rainwater to be collected from the roof of this factory can be used for irrigation of the garden area of the factory, in sinks, and in areas such as surface cleaning. The roof surface area of the factory is 42414 m².

In order to determine the amount of water that can be collected from the roofs, it is necessary to calculate the rainwater yield.

Rainwater yield = Rainfall area * annual precipitation * roof coefficient * filter efficiency coefficient

- Rain collection area: It refers to the total roof area.
- Precipitation amount: Indicates the total annual rainfall.
- Roof coefficient: It is specified as 0.8 in German standards [27]. It states that not all of the rain falling on the roof surface can be recycled.
- Filter efficiency coefficient: It is specified as 0.9 in German standards [27]. It is the efficiency coefficient of the first filter used to separate the rainwater collected from the roof from the solids. It is a coefficient determined by taking into account that a certain part of the rainwater cannot pass through the filter [7].

5. RESULTS AND DISCUSSION

Kütahya is located in the Aegean Region at 29.98° longitude and 39.42° latitude circles. The 2021 population of the city, which has an area of 12043 km², is 578640 people, and 50 people per km² [28, 29]. Kütahya, whose history dates back to 3000 BC, has been an important center during the Hittite, Phrygian, Lydian, Persian, Macedonian, Bithynian, Pergamon Kingdom, Roman and Byzantine Empires, Seljuk and Ottoman Empires. In Kütahya, where the world's largest ceramic, porcelain and glass industries are located, 35 different precious metals are mined. It is also an important hot spring center with the richest water resources in the world [30]. Kütahya, which is one of the cities worth seeing with its thermal resources, natural beauties, and tiles, contributes to the country's economy in the service, agriculture, and industry sectors. Plains are warm, and plateaus and mountains are cold. Half of its lands are covered with forests and heaths, 12% with meadows and pastures, and 35% with cultivated areas. Forests are located on very high plateaus. Black pine, juniper, and oak trees predominate in the forests [31]. In Kütahya, with an average annual precipita-

tion of 600-1100 mm, the coldest months are January and February, and the hottest months are July and August. The precipitation data of Kütahya are given in Table 1 [32]. According to Table 1, it is seen that the month with the highest average rainfall in December with a value of 77.5 mm; and the month with the lowest value is August with a value of 17.6 mm.

Table 1. Monthly average temperature values and precipitation amounts of Kütahya between 1929-2021

Kütahya	January	February	March	April	May	June	July	August	September	October	November	December	Yearly
Average temperature (°C)	0.4	1.8	5.0	10	14.6	18.2	20.8	20.8	16.7	11.9	6.8	2.4	10.8
Average number of rainy days	12.24	10.35	13	10.94	12.24	11.12	3.41	3.94	6.53	9.76	7.76	12.24	113.53
Average monthly total precipitation amount (mm)	73	59.2	57.5	50.4	55.8	39.6	19.6	17.6	23.6	40.8	49	77.5	563.6

5.1. Rainwater Yield Calculation

The roof surface area of the factory, where rainwater calculations are made, is 42414 m². According to Table 1, the annual precipitation per square meter in Kütahya between 1929 and 2021 was 563.6 mm (563.6 L/m²). The amount of precipitation falling on the area covered by the roof;

$$\text{Rainwater yield} = \text{Rain catchment area} * \text{rainfall} * 0,8 * 0,9$$

$$42414 \text{ m}^2 * 563.6 \text{ L/m}^2 * 0.8 * 0.9 = 17211.3 \text{ m}^3/\text{year}$$

5.2. Total Water Requirement

On average, 20% of the water withdrawn in the world is used for industry. This rate, which was 17.2% in our country according to 2012 data and is expected to reach 20% in 2030, is similar to the world average. In Europe, 40% of the water supplied on average is used in industry. These rates also include energy production (cooling water in thermal power plants). When the amount of water used for energy production in the in-

dustry is excluded, the rate of water used for industrial production (manufacturing industry, organized industrial zones, mining enterprises) in our country drops to 4% [33]. The European average is reported as 10% [34].

Calculations have been made considering that there will be irrigation two days a week in the factory, which has a green area of 2500 m².

- In the calculation of the water requirement of the green areas, the amount of water for each irrigation was accepted as 5 L/m².

$$2500 \text{ m}^2 * 5 \text{ L/m}^2 = 12500 \text{ L} = 12.5 \text{ m}^3/\text{day}$$

If watering is done twice a week; $12.5 \text{ m}^3/\text{day} * 365/(7/2) \text{ day} = 1303.57 \text{ m}^3/\text{year}$

- Water consumption in sinks;

The number of employees in the factory is 3000 people.

The amount of water used by a person while flushing is 9 liters on average. Considering that it siphons 3 times a day;

$$9 \text{ L} * 3 = 27 \text{ L}$$

$$\text{In a year; } 27 \text{ L} * 365 = 9855 \text{ L/year}$$

Annual sink use of 3000 people;

$$3000 * 9855 \text{ L/year} = 29\ 565\ 000 \text{ L} = 29565 \text{ m}^3/\text{year}$$

The amount of water required to fill the ornamental pool;

When calculating the amount of water required to fill the 7 m³ ornamental pool in the factory, the amount of water needed considering that it will be filled and emptied twice a year;

$$7 \text{ m}^3 * 2 = 14 \text{ m}^3/\text{year}$$

Annual total water requirement = Garden irrigation + Water consumption in washbasins + Water requirement of ornamental pools

$$1303.57 \text{ m}^3/\text{year} + 29565 \text{ m}^3/\text{year} + 14 \text{ m}^3/\text{year} = 30882.57 \text{ m}^3/\text{year}$$

The amount of rainwater collected from the roof / the amount of water used =

$$17211.3 \text{ m}^3/\text{year} / 30882.57 \text{ m}^3/\text{year} = 0,55 \text{ year} \approx 201 \text{ day}$$

It has been determined that the water collected in the tank can be used for 201 days.

5.3. Warehouse volume calculation

The storage volume calculation of the system was made considering the month of December when the maximum precipitation occurs.

$$\text{Warehouse volume} = \text{precipitation} * \text{square meters of roof} * 0.8 * 0.9$$

$$77.5 \text{ L/m}^2 * 42414 \text{ m}^2 * 0.8 * 0.9 = 2366701.2 \text{ L} = 2366.7 \text{ m}^3 \approx 2367 \text{ m}^3$$

warehouse volume is required.

5.4. Annual savings

The water use of 17211.3 m^3 of the factory, which has a total annual water consumption of 657000 m^3 , can be met by rainwater.

The annual amount of water saved is 17211.3 m^3 and Kütahya Water and Sewerage Administration's water sales price (mains water fee) including wastewater cost 6.2 TL/m^3 [35];

$$\text{Amount saved annually} = 17211.3 * 6.2 = 106710 \text{ TL}$$

Studies on the applicability of rainwater harvesting in factories are quite limited. A study was carried out by Bertuzzi and Ghisi [22] on a pre-cast concrete factory in Brazil. The results showed that the rainwater tank capacity was 25 tons, and collected water savings were between 50.2% and 54.6%. The water savings for three years were found as 45.3% in a rainwater harvesting study on a skin-deo factory conducted by Sari et al. [36].

6. CONCLUSIONS

In today's conditions, where water resources are rapidly depleted, it is very important to use existing water sparingly and to search for new water resources. As a new water source, rainwater harvesting is a cost-effective and reliable alternative and contributes to the conservation of freshwater. The fact that the collected rainwater can be used for different purposes by passing through simple purification methods makes rainwater harvesting attractive.

In this study, the amount of rainwater that can be harvested from the roof of a factory in Kütahya with a roof area of 42414 m^2 was calculated. As a result of the calculations, it has been determined that 17211.3 m^3 of annual rainwater can be harvested. Also, the harvested water could be used for irrigation of green areas, and filling ornamental pools, and sinks for 201 days. With these savings, it will be possible to reduce water consumption and contribute to the country's economy by irrigating green areas, filling

the ornamental pool twice a year, and using the clean water obtained from buildings with a large water collection area, such as the factory. Based on all these calculations, it is concluded that the rainwater collection system applied to the factory is an advantageous system.

In today's world where there is a shortage of water and water supply causes great costs, both cheap and practical systems such as rainwater harvesting should be expanded. It is thought that with the dissemination of these systems, the ecological balance will be protected, sustainable development will be ensured and water resources will be used more efficiently.

REFERENCES

- [1] Yalılı Kılıç, M., Kestioğlu, K. & Aydınalp, C. (2008). Atıksuların sulama suyu olarak kullanım olanaklarının değerlendirilmesi. *Su Tüketimi, Arıtma, Yeniden Kullanım Sempozyumu*, 355-366, İznik, Bursa.
- [2] Yalılı Kılıç, M., Akal Solmaz, S.K. & Elmacı, A. (2020). The role of institute managers in water and electrical consumption in central public institutions: case study of bursa. *BEU Journal of Science*, 9(1), 255-263.
- [3] Aditya, G., Sudhir, M., Neeraj, B. & Kishore, K. (2016). Need of smart water systems in india. *International Journal of Applied Engineering Research*, 11(4), 2216-2223.
- [4] Uyduranoğlu Öktem, A. & Aksoy, A. (2014). Türkiye'nin su riskleri raporu. WWF-Türkiye, 978-605-86596-7-4.
- [5] <https://www.dogadergisi.com/yagmur-suyu-hasadi/> Access: 10.12.2022
- [6] Pamuk Mengü, G. & Akkuzu, E. (2008). Global water crisis and water harvesting techniques. *Journal of Adnan Menderes University Agricultural Faculty*, 5(2), 75-85.
- [7] Yalılı Kılıç, M. & Abuş, M.N. (2018). Rain water harvesting in a garden house sample. *International Journal of Agriculture and Wildlife Science*, 4(2), 209-215.
- [8] Pekin Timur, U., Ediş, S., Timur, Ö.B. & Göl, C. (2012). Water harvesting techniques in urban areas and campus; planning and designing. *Reserach Journal of Agricultural Sciences*, 5(1), 170-174.
- [9] Ekinci, B. (2015). Su kaynaklarının verimli kullanılmasına yönelik örnek ülke uygulamaları ve ülkemizde bu çalışmaların uygulanabilirliği. *Uzmanlık Tezi*, T.C. Orman ve Su İşleri Bakanlığı, Ankara.
- [10] Yalılı Kılıç, M. & Adalı, S. (2022). Rainwater harvesting in a shopping mall example. *Uludag University Journal of the Faculty of Engineering*, 27(1), 29-40.
- [11] Hajjar, H., Kılınç, İ.K. & Ülker, E. (2020). Rainwater harvesting potential in public buildings: a case study in katip celebi university. *Turkish Journal of Nature and Science*, 9: 167-172.
- [12] Andavar, V., Ali, B.J. & Ali, S.A. (2020). Rainwater for water scarcity management: an experience of woldia university (ethiopia). *Journal of Business, Economics and Environmental Studies*, 10(4): 29-34.
- [13] Sung, M., Kan, C.C., Wan, M.W., Yang, C.R., Wang, J.C., Yu, K.C. & Lee, S.Z. (2010). Rainwater harvesting in schools in taiwan: system characteristics and water quality. *Water Science and Technology*, 61(7): 1767-1778.
- [14] Matos, C., Bentes, I., Santos, C., Imteaz, M. & Pereira, S. (2015). Economic analysis of a rainwater harvesting system in a commercial building. *Water*

Resource Management, 29: 3971-3986.

- [15] Liang, X. & van Dijk, M.P. (2011). Economic and financial analysis on rainwater harvesting for agricultural irrigation in the rural areas of Beijing. *Resources, Conservation and Recycling*, 55: 1100-1108.
- [16] Hacısalıhoğlu, S. (2022). Contribution of water harvesting practices to the sustainability of rural areas: bursa karacabey case study, *OKU Journal of the Institute of Science and Technology*, 5(2): 767-782.
- [17] Neto, R.F.M., de Castro Carvalho, I., Calijuri, M.L. & da Fonseca Santiago, A. (2012). Rainwater use in airports: a case study in brazil. *Resources, Conservation and Recycling*, 68: 36-43.
- [18] Jaiyeola, A.T. (2017). The management and treatment of airport rainwater in a water-scarce environment. *International Journal of Environmental Science and Technology*, 14: 421-434.
- [19] Pimentel-Rodrigues, C. & Silva-Afonso, A. (2022). Rainwater harvesting for irrigation of tennis courts: a case study. *Water*, 14: 752.
- [20] Dingle, G., Dickson, G. & Stewart, B. (2022). Major sport stadia, water resources and climate change: impacts and adaptation. *European Sport Management Quarterly*, 2022: 1-10.
- [21] Bhattacharjee, S. & Saha, B. (2016). Existing practices and utilization of rainwater to minimize the water use in textile, industry: a review of industrial implementation. *Journal of Data Processing*, 6(4): 123-130.
- [22] Bertuzzi, G. & Ghisi, E. (2021). Potential for potable water savings due to rainwater use in a precast concrete factory. *Water*, 13: 448.
- [23] Sojka, S., Younos, T. & Crawford, D. (2016). Modern urban rainwater harvesting systems: design, case studies, and impacts. *The Handbook of Environmental Chemistry*, pp. 209-234, ISBN 978-3-319-29335-6, Springer.
- [24] Yiğit, A.Y., Orhan, O. & Ulvi, A. (2020). Investigation of the rainwater harvesting potential at the mersin university, turkey. *Mersin Photogrammetry Journal*, 2(2), 64-75.
- [25] Sahu, D.P. & Verma, M.K. (2022). Sustainable rainwater harvesting system and storm water management: a case study in raipur airport. *Hydrological Modeling*, 109, 479-490.
- [26] Nyatuame, M. & Atigah, S., (2012). Assessment of a rainwater harvesting system for the volta regional hospital in ghana. *International Journal of Technology and Management Research*, 1, 28-32.
- [27] Regenwassernutzungsanlagen. Deutsches Institut Normung DIN: 1989, German.
- [28] <https://kutahya.ktb.gov.tr/> Access: 26.09.2022
- [29] <https://data.tuik.gov.tr/Kategori/GetKategori?p=Nufus-ve-Demografi-109> Access: 26.09.2022

- [30] <https://www.dpu.edu.tr/index/sayfa/16/kutahya-hakkinda> Access: 26.09.2022
- [31] <https://tr.wikipedia.org/wiki/K%C3%BCtahya> Access: 26.09.2022
- [32] www.mgm.gov.tr Access: 30.09.2022
- [33] <https://www.eea.europa.eu/publications/binaryeenviasses01pdf> Access: 11.10.2022
- [34] <https://ced.csb.gov.tr/cevresel-gostergeler-kitapcigi-i-82681> Access: 11.10.2022
- [35] <https://www.kutahya.bel.tr> Access: 12.10.2022
- [36] Sari, P.A., Ardiatma, D. & Ismanto, H. (2020). Evaluation of rainwater harvesting system on skin-deo factory cikarang. *Proceedings of the 1st International Conference on Economic Engineering and Social Science*, July 17-18, Bekasi, Indonesia, pp. 232-242.

“

Chapter 12

**EVALUATION OF PERFORMANCE
OF EARTHQUAKE PARAMETERS BY
MACHINE LEARNING (CASE OF STUDY
CENTRAL ANATOLIA REGION)**

*Mahmut SARI¹,
Mesut MELEK²,
Abdullah GERZAN³*

”

1 Dr. Öğr. Üyesi ORCID:0000-0002-1006-6332E-mail: msari@gumushane.edu.tr

2 Doç. Dr. ORCID:0000-0002-1006-6332E-mail: mesutmelek@gumushane.edu.tr

3 ORCID:0000-0002-7178-942XE-mail: abdullah_gerzan@hotmail.com

1. Introduction

Due to the material and moral losses they cause, earthquakes are the most important and most emphasized disaster type in natural disasters. Since there are many different variables that trigger the formation mechanism of earthquakes, studies on predicting earthquakes emerge as a very complex and difficult field. Today, there are many studies on this subject in the literature (Öztürk et al., 2018; Öztürk et al., 2020; Frohlich and Davis, 1993; Console et al., 2000; Wu and Chiao, 2006; Polat et al., 2008; Katsumata, 2011; Coban and Sayil, 2019). The causes of earthquakes should be precisely identified in order to use the nation's resources, which could be regarded limited, for the right and effective solutions. The past data sets can be trained with machine learning and artificial intelligence algorithms, and statistical studies can be conducted to predict the earthquakes that have not yet occurred in the future. These studies can be done using the statistical records of the earthquakes that occurred in the past (magnitude, occurrence time, location, depth, etc.) (Öztürk, 2020; Chiba, 2019; Bozkurt, 2001; Özsayın and Dirik, 2007). Within the parameters of this study, the 16702 earthquake data magnitudes that occurred in Turkey between 1974 and 2019 were modeled using machine learning in a Matlab program with 7 main modeling and 26 sub-modeling and cross-validation method, and the processing stages were provided (Figure 1).

There are multiple factors that affect machine learning. The first of these is the data set presented to the machine as an experience. Like in people, learning will be aided by experiences to a greater extent if they cover a wider range of potential situations. The second factor is the presence of variables that are thought to have an effect on the result in the data set. In some problems, features that are found to be highly correlated or have little contribution to the solution can be eliminated. The learning approach used makes up the third factor. The objective for which the machine is to be trained as well as the data collection needed are both intimately tied to the learning approach. Because machine learning needs output values in the data set to solve some problems, while it does not need these values in others. The output value is called target attribute in studies. It is clear that estimation and classification issues are the most common challenges that call for the target attribute. As a result, it's crucial to choose the learning technique for the machine learning task at hand and to supply the right data collection to support it. The learning algorithm and any associated parameters make up the fourth factor. The algorithm can be expressed as the step-by-step path to be followed to solve a given problem. Naturally, there are several procedures that must be taken before the computer can learn from the data set it has (Balaban et al., 2018).

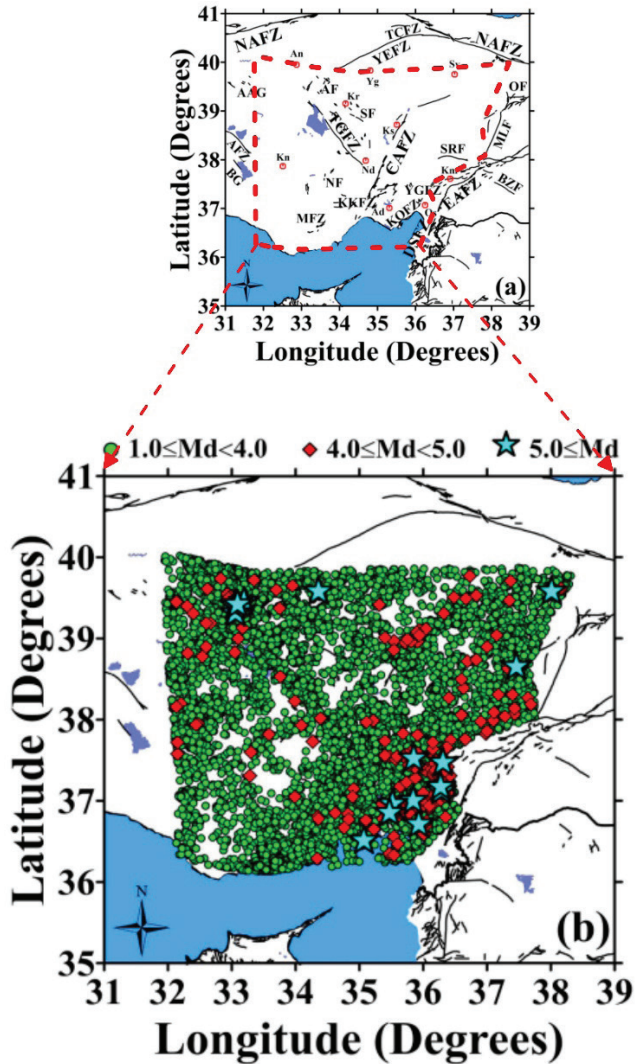

Figure 1. (a) From Arolu et al. (1992), Bozkurt (2001), and Ulusay et al., (2004) simplified tectonic settings. The text included the names of the faults, and the picture included some of the provinces in and around the research region. A: Ankara Yozgat, Sivas, and Kn: Konya, Ks: Kayseri, Kr: Krşehir Nd: Negate, Km: Karamamaraş, Os: Osmaniye, and Ad: Adana. (b) Epicenter distributions for the (Central Anatolia Region) CAR and its surroundings from the original dataset, which included 16,702 shallow earthquakes with $M_d \geq 1.0$ from 1974 to 2019. The magnitude values of the occurrences were represented by several indicators (Öztürk, 2020).

2. Material and Method

Within the scope of this study, the catalog used for earthquakes between 1970-2019 was taken from Öztürk, 2020. The database of 16702 shallow earthquakes (depth 70 km) with magnitudes ranging from 1.0 to 6.0 between September 1974 and December 2019 was used for the statistical region-time analysis. The earthquake catalog used is homogeneous and continuous within a time interval of approximately 44.29 years according to the duration magnitude M_d . Figure 1b depicts the original earthquake catalog, which included 16702 events used in the analysis, using various symbols for various magnitude groups.

Machine learning methods have been proven in different studies to be a powerful tool with undeniable advantages in complex problems when data is dense or non-linear (Manshouri et al., 2020). These methods are generally data-driven, non-parametric, and less constrained by inductive assumptions (Sikder et al., 2009). RMSE and Cross validation methods were used to evaluate the performance of making predictions on datasets.

2.1. Root Mean Square Error (RMSE)

The standard deviation of residuals is known as RMSE (estimate errors). The regression line's residuals provide a gauge of how far it is from the data points. The RMSE shows how widely distributed these residues are. In other words, it offers details about the level of data surrounding the optimum line. In climatology, forecasting, and regression analysis, root mean square error is frequently employed to support experimental findings (Glen, 2021). The following equation describes how to calculate the RMSE.

$$RMSE = \sqrt{\frac{\sum_{t=1}^n (u)^2}{n}}$$

2.2. Croos Validation Method

The cross-validation method is a model evaluation approach used to assess how well a machine learning algorithm performs when making predictions on fresh datasets. In this method, the data set is divided into two parts; training set and test set. The parameters are set to their ideal values and the system is trained using the training set. The performance of the system is then assessed using the test set. This method is used in different ways in the literature. In this study, the K-fold cross validation method was used. This method divides the data set into K equal parts at random, then uses one part at a time for testing while using the remaining parts to train the system and averaging the RMSE result (Manshouri et al., 2020). Thus,

K-fold cross validation also helps to select the best performing model. The goal of this study's models, which are divided into 5, 10, 30, and 50 components, is to apply machine learning to produce estimates that are as near to the real values as possible.

3. Results

3.1. Linear Regression Models

A statistical technique for examining and simulating the relationship between variables is regression analysis (Montgomery et al., 2012). However, the theoretical prerequisites and applications of this method typically differ significantly from one another. The most frequently used method for estimation of model parameters in regression analysis is the least squares (LCS) method. However, it is well recognized that certain observations in the dataset have a significant impact on the LCS technique, and the regression model reflects this impact rather than the relationship between the variables (Cook and Weisberg, 1982).

In this modeling study, the magnitudes of 16702 earthquakes that occurred in CAR between 1974 and 2018 were divided into 5 - 10 - 30 and 50 parts and the closest estimated values to the actual magnitude values were tried to be obtained. The RMSE error rates found in this method are given in the table below.

Table 1. Linear Regression Model Data Process Results

Linear Regression Models				
Modelings	RMSE			
	Cross Validation Folds (5)	Cross Validation Folds (10)	Cross Validation Folds (30)	Cross Validation Folds (50)
Linear Regression	0,43478	0,43472	0,43471	0,43469
Interactions Linear	0,42649	0,4264	0,4264	0,4264
Robust Linear	0,43565	0,4356	0,43558	0,43557
Stepwise Linear	0,4266	0,42641	0,42649	0,42656

As a result of this model, the estimated error rate closest to the magnitude results of the earthquake data was obtained by dividing the data into 50 parts in the Interactions linear method. Below is our graph that displays the closest estimated error rate (Figure 2).

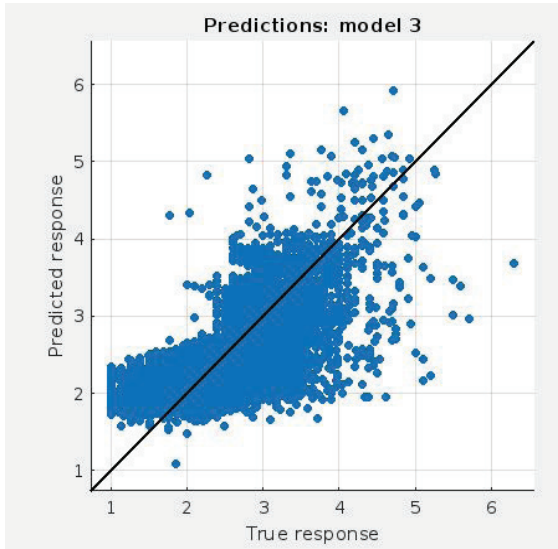

Figure 2. The RMSE distribution of the Interactions linear method

3.2. Regression Trees

The first mathematically based use of decision trees dates back to 1963. Morgan ve Different algorithms have developed over time as a result of some of Sonquist's proposed algorithm's drawbacks (Sharma et al., 2013).

Decision trees are a plain and simple construct that express a sequential classification process in which an event characterized by a set of attributes is assigned to one of the several sets of classes, according to Quinlan (1987), who made a significant addition to decision tree approaches. Decision trees; It is a set of models that are simple to understand, represent classification models, and are very widely used, especially because they resemble a tree structure. This technique is superior to other methods since it visualizes the analysis results with a tree structure (Barros et al., 2015). Decision trees are structures used to divide databases into smaller structures by applying various rules. The structure of the generated data converges more and more with each subsequent iterative split (Irmak and Ercan, 2017). The order of importance of the independent factors affecting the dependent variable can be established, and they can also be visually displayed with an inverse tree structure, even in the presence of very complicated data structures (Güner, 2014).

Table 2. Data Processing Results of Regression Trees Model

Regression Trees				
Modelings	RMSE			
	Cross Validation Folds (5)	Cross Validation Folds (10)	Cross Validation Folds (30)	Cross Validation Folds (50)
Fine Tree	0,42214	0,42029	0,4148	0,41768
Medium Tree	0,38328	0,38103	0,38082	0,38055
Coarse Tree	0,36636	0,36625	0,3655	0,36578

As a result of the study, the estimated error rate closest to the magnitude results of the earthquake data was obtained by dividing the data into 30 parts in the Coarse Tree method. Below is our graph, which displays the closest estimated error rate (Figure 3).

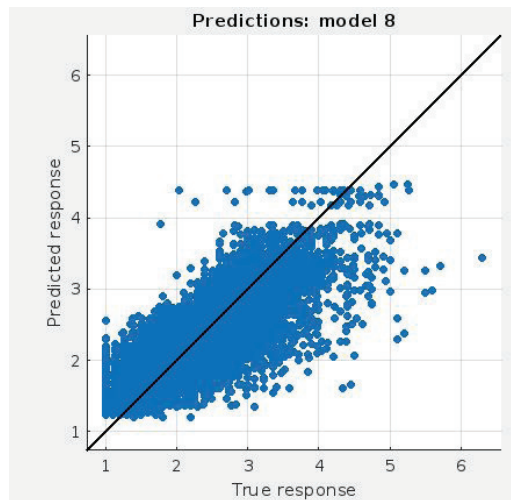

Figure 3. The RMSE distribution obtained from the Coarse Tree method

3.3. Support Vector Machines

Artificial neural networks (ANN), support vector machines (SVM), and fitness vector machines (RVM) are examples of soft computation techniques that have been effectively employed in recent years to estimate the liquefaction potential more accurately than other statistical methods. Genetic programming (GP), an evolutionary soft computing approach based on Darwinian theory of natural selection, has recently been employed as a substitute soft computing approach.

A recent advancement in machine learning is the support vector machine (SVM), which simultaneously reduces prediction error and model complexity. SVM is based on statistical learning theory, in contrast to ANN modeling, which is based on a biologically inspired method. The popularity of the support vector machine is growing as a result of its strong generalizability (Vapnik, 1998).

Table 3. Data Processing Results of Support Vector Machines Model

Support Vector Machines				
Modelings	RMSE			
	Cross Validation Folds (5)	Cross Validation Folds (10)	Cross Validation Folds (30)	Cross Validation Folds (50)
Linear Support Vector Machines	0,43595	0,43604	0,43612	0,43602
Quadretic Support Vector Machines	0,41935	0,41932	0,41932	0,4194
Cubic Support Vector Machines	0,40472	0,40367	0,40327	0,40337
Fine Gaussian Support Vector Machines	0,50001	0,49406	0,49135	0,49046
Medium Gaussian Support Vector Machines	0,3902	0,38891	0,38853	0,3880
Coarse Gaussian Support Vector Machines	0,41865	0,41822	0,41805	0,41809

As a result of the study, the closest estimated error rate to the magnitude results of the earthquake data was obtained by dividing the data into 50 parts in the Medium Gaussian Support Vector Machines method. Our graph that gives the closest estimated error rate is as shown below (Figure 4).

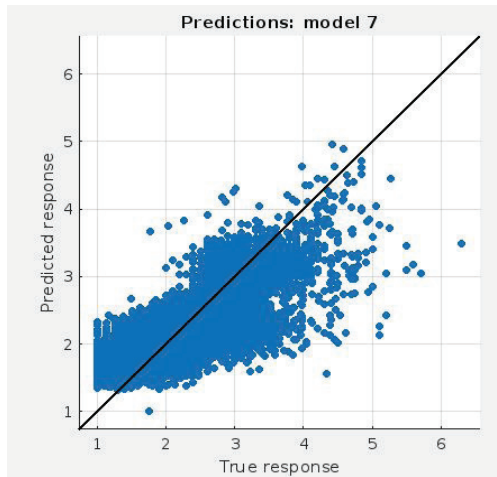

Figure 4. RMSE distribution of the Medium Gaussian Support Vector Machines method

3.4. Gaussian Process Regression

Gaussian processes (Williams and Rasmussen, 2006) are adaptable non-parametric function models that enable probabilistic estimation and attain the highest possible estimation accuracy (Gneiting et al., 2007). This method, which belongs to the class of probabilistic supervised machine learning techniques, is applied to classification and regression issues. This non-parametric Bayesian regression technique, which computes a probability distribution across potential functions, is used to approximate the Gaussian process (Ates, 2020; Knagg, 2020). This process' approach is a potent one for simulating nonlinear interactions between groups of random variables. creates a distribution of functions that might be used to cast doubt on the validity of the functional link (2006) Williams and Rasmussen.

Table 4. Gaussian Process Regression Model Data Process Results

Gaussian Process Regression				
Modelings	RMSE			
	Cross Validation Folds (5)	Cross Validation Folds (10)	Cross Validation Folds (30)	Cross Validation Folds (50)
Rational Quadretic	0,38793	0,38781	0,38181	0,38085
Squared Exponential	0,3938	0,3944	0,3934	0,39104
Matern 5/2	0,39034	0,38952	0,38752	0,38655
Exponential	0,38591	0,38487	0,38587	0,3805

As a result of the study, the estimated error rate closest to the magnitude results of the earthquake data was obtained by dividing the data into 50 parts in the Exponential method. Our graph that gives the closest estimated error rate is as shown below (Figure 5).

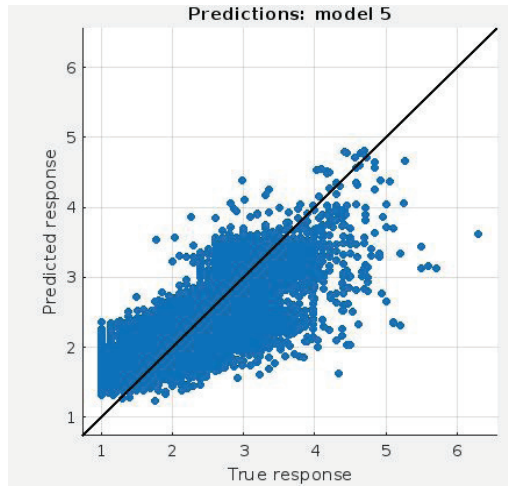

Figure 5. The RMSE distribution of the exponential method

3.5. Kernel Approximation Regression

Regression Kernel is a model object trained for Gaussian Kernel regression using random feature expansion. Regression Kernel may also be used with smaller datasets that fit in memory and is more feasible for big data applications with huge training sets. Unlike other regression models and for economical memory usage, Regression Kernel model objects do not store training data. They do, however, keep data like the kernel scale parameter, the regularization intensity, and the size of the extended field.

Table 5. Kernel Approximation Regression Model Data Process Results

Kernel Approximation Regression				
Modelings	RMSE			
	Cross Validation Folds (5)	Cross Validation Folds (10)	Cross Validation Folds (30)	Cross Validation Folds (50)
Svm Kernel	0,42433	0,42337	0,42344	0,42554
Least Squares Kernel	0,42383	0,42290	0,42244	0,42104

As a result of the study, the closest estimated error rate to the magnitude results of the earthquake data was obtained by dividing the data into 50 parts in the Least Squares Kernel method. Below is our graph, which displays the closest estimated error rate (Figure 6).

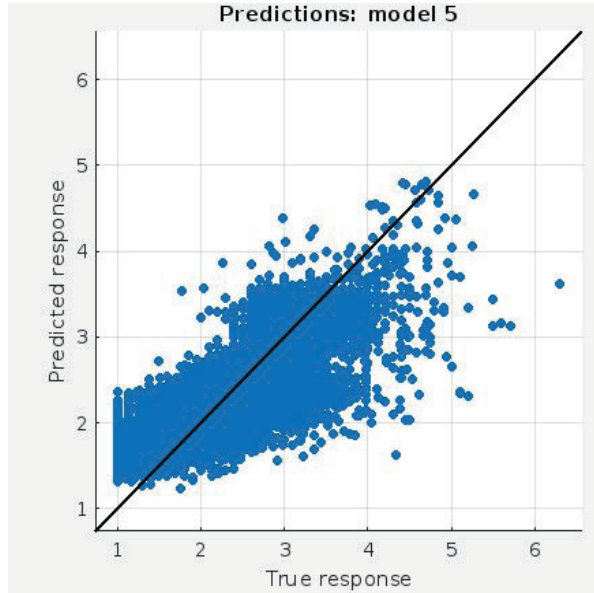

Figure 6. RMSE distribution of Least Squares Kernel method

3.6. Ensembles Of Trees

One of the methods used to develop a model is the EBT approach. To increase the prediction accuracy of discrete learning algorithms, ensemble methods mix various learning techniques. They linearly mix a variety of modeling strategies to achieve improved prediction outcomes without noticeably increasing complexity. The Bagged and Boosted procedures are two of the most widely used ensemble techniques (Buhlmann, 2012). While boosted methods primarily lower the bias value of constructor learning algorithms, bagged methods serve as an error variance reduction method for constructor learning algorithms.

Table 6. Ensembles Of Trees Model Data Processing Results

Ensembles Of Trees				
Modelings	RMSE			
	Cross Validation Folds (5)	Cross Validation Folds (10)	Cross Validation Folds (30)	Cross Validation Folds (50)
Boosted Trees	0,38398	0,38376	0,38373	0,38366
Bagged Trees	0,34864	0,34799	0,34693	0,34593

As a result of the study, the closest estimated error rate to the magnitude results of the earthquake data was obtained as a result of dividing the data into 50 parts in the Bagged Trees method. Our graph that gives the closest estimated error rate is as shown below (Figure 7).

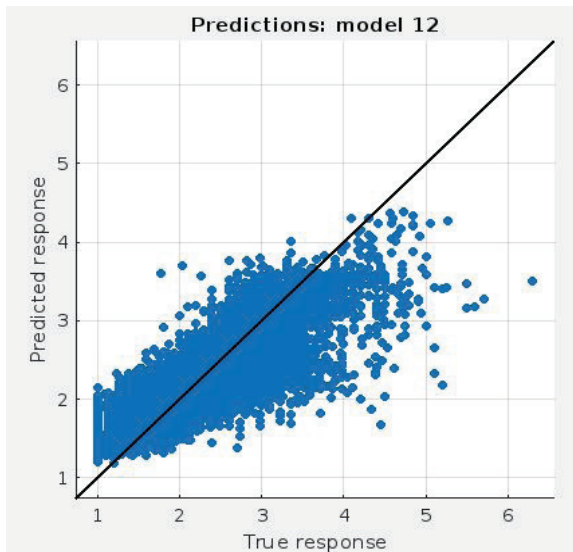

Figure 7. The RMSE distribution obtained from the Bagged Trees method

3.7. Neural Networks

An artificial neural network is a parallel computing system that has the following characteristics: it is a mathematical model that was inspired by nature, it comprises of many connected processing units, and it stores information about the connections between those units (weights). Input signals reach the processing element through links and link weights, and each neuron has the ability to dynamically respond to its input stimuli, with the response solely based on its local knowledge. Neurons can also learn to generalize from experience and can recall from training. While a single

neuron does not hold specific information, the information is dispersed among neurons with a huge computational capability, as shown by the data and collective behavior when the connection weights are changed (Lin and Lee, 1996). Various neural network architectures exist. These designs' algorithms and function formulas set them apart from one another. A typical ANN structure is made up of a number of interconnected processing elements (PE), also known as neurons. An input layer, an output layer, and one or more hidden layers make up the logically organized layers of neurons. Weighted connections between neurons enable interaction (Figure 8).

Every neuron in the layer below is linked to every other neuron. Data is supplied to the network through the input layer. The network's reaction to the input is stored in the output layer. Because of the hidden layers, these networks can compute and encode complicated connections between inputs and outputs (Lin and Lee, 1996).

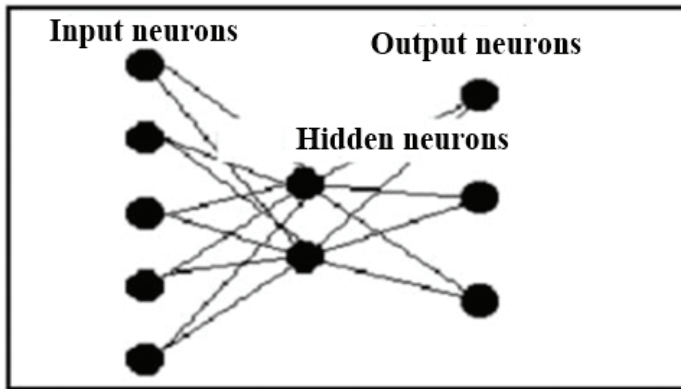

Figure 8. Neural networks structure (Ural et al. 2003).

Table 7. Neural Networks Model Data Process Results

Neural Networks				
Modelings	RMSE			
	Cross Validation Folds (5)	Cross Validation Folds (10)	Cross Validation Folds (30)	Cross Validation Folds (50)
Narrow Neural Network	0,37934	0,38038	0,38173	0,38084
Medium Neural Network	0,37488	0,37091	0,37148	0,37231
Wide Neural Network	0,38474	0,38127	0,37787	0,37765
Bilayered Neural Network	0,36538	0,36505	0,36681	0,36652
Trilayered Neural Network	0,36819	0,36668	0,36491	0,36392

As a result of the study, the estimated error rate closest to the magnitude results of the earthquake data emerged as a result of dividing the data into 50 parts in the Trilayered Neural Network method. Our graph that gives the closest estimated error rate is as shown below (Figure 9).

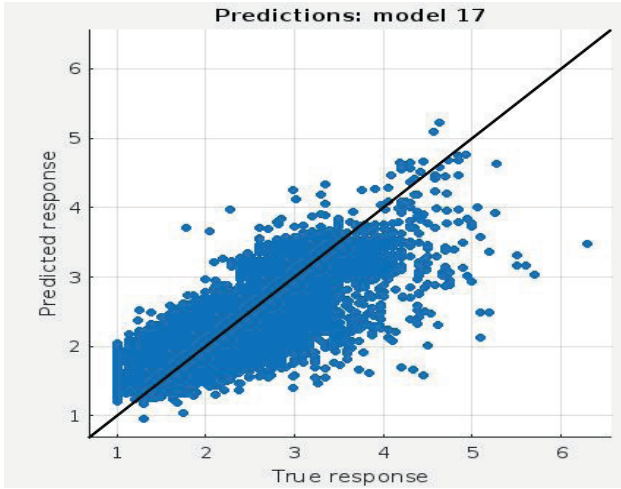

Figure 9. The RMSE distribution obtained from the Trilayered Neural Network method

4. Conclusions

In this study, the magnitude values of 16702 earthquake data that occurred in Turkey between 1974 and 2018 were examined to obtain the closest estimated values to the real values by machine learning method, and the results are given below.

- The Croos Validation method is used to test the earthquake parameters in the Matlab application, and the cross Validation folds Estimates were made using the intervals 5 - 10 - 30 and 50
- In the performance evaluations carried out with 7 different models, the **Bagged Trees model**, which is one of the Ensembles Of Trees methods that estimates the closest to the real value, gave the best result when the Cross Validation folds Interval 50 was selected, and it was determined as **RMSE= 0.34593**.

References

- Ateş B (2020). Realization of Stress Concentration Predictions in Ship Structures with Coarse Network Structure and Machine Learning. Istanbul Technical University. Ship and Marine Technologies Engineering Department Ship and Marine Technology Engineering Program, Master Thesis.
- Balaban Erdal M., Kartal E. 2018. Data Mining and Machine Learning Basic Algorithms and Applications with R Language (Second Edition), İstanbul: Çağlayan Bookstore and Education Solutions Trade
- Barros, R., Carvalho, A., & Freitas, A. (2015). Automatic Design of Decision-Tree Induction Algorithms. New-York: SpringerBriefs in Computer Science.
- Bozkurt E. 2001. Neotectonics of Turkey-a synthesis, *Geodinamica Acta*. 14 3-30.
- Bühlmann P, “Bagging, boosting and ensemble methods,” in *Handbook of Computational Statistics*. Springer, 2012, pp. 985–1022
- Chiba K. 2019. Spatial and temporal distributions of b-values related to long-term slow-slip and low-frequency earthquakes in the Bungo Channel and Hyuga-nada regions, Japan, *Tectonophysics*. 757 1-9.
- Coban, K.H., Sayil, N., 2019. Evaluation of earthquake recurrences with different distribution models in western Anatolia. *J. Seismol.* 23, 1405–1422.
- Cook, R. D. and Weisberg, S. (1982). *Residuals and influence in regression*. (First edition). New York: Chapman and Hall, 14-20.
- Console, R., Montuori, C., Murru, M., 2000. Statistical assessment of seismicity patterns in Italy: are they precursors of subsequent events *J. Seismol.* 4, 435–449.
- Frohlich, C., Davis, S., 1993. Teleseismic b-values: or, much ado about 1.0. *J. Geophys. Res.* 98 (B1), 631–644.
- Glen S. Root Mean Square Error, Access Address: [<https://www.statisticshowto.com/probability-and-statistics/regression-analysis/rmse-root-mean-square-error/>]. Date Of Access: 10.03.2021.
- Gneiting T, Balabdaoui F, Raftery AE (2007). Probabilistic Forecasts, Calibration and Sharpness. *Journal of The Royal Statistical Society: Series B (Statistical Methodology)*, 69 (2), 243-268
- Guner, Z. B. (2014). “The Role of Cart and Logistic Regression Analysis in Data Mining: An Application on Drug Provision System Data”. *Journal of Social Security*, (6), 53-99.
- Irmak, S., & Ercan, U. (2017). “Determination of Turkish Household Olive Oil Consumption Outlook Using Decision Trees”. *int. Journal of Management Economics and Business*, 13(3), 553-564.
- Knagg O (2019). An Intuitive Guide to Gaussian Processes. Access Address: [<https://towardsdatascience.com/an-intuitive-guide-to-gaussian-processes-ec2f0b45c71d/>]. Date Of Access: 07/12/2020.
- Katsumata, K., Kasahara, M., 1999. Precursory seismic quiescence before the 1994 Kurile Earthquake (Mw=8.3) revealed by three independent seismic

- catalogs. *Pure Appl. Geophys.* 155, 43–470.
- Lin C. T. and Lee C. S. G. (1996). *Neural fuzzy systems*, Prentice Hall Inc.
- Manshouri N., Kayıkcıoğlu T., 2020. A Comprehensive Analysis of 2D&3D Video Watching of EEG Signals by Increasing PLSR and SVM Classification Results, *The Computer Journal*, Volume 63, Issue 3, Pages 425–434.
- Manshouri N., Maleki M., Kayıkcıoğlu T., An EEG-based Stereoscopic Research of the PSD Differences in Pre and Post 2D amp 3D Movies Watching, *Biomedical Signal Processing and Control*, vol. 55, pp. 101642–0
- Montgomery, D. C., Peck, E. A. and Vining, G. G. (2012). *Introduction to linear regression analysis*. (Fifth Edition). New York: John Wiley and Sons, 1.
- Özsayın E., Dirik K. 2007. Quaternary activity of the Cihanbeyli and Yeniceoba fault zones: İnönü-Eskişehir fault system, Central Anatolia, *Turk. J. Earth Sci.* 16 471-492.
- Öztürk S., Ghassemi M. R., and Sari M., 2018. Empirical relations among the parameters associated with earthquake faulting mechanisms for Iranian earthquakes, *Sigma Journal of Engineering and Natural Sciences*, vol. 36, no. 1, pp. 301–310.
- Öztürk S., Ghassemi M. R., and Sari M., 2020. A comparison of alternative curve fitting techniques for different earthquake fault parameters of Iranian earthquakes, *Earth Sciences Research Journal*, pp. 0–0.
- Öztürk S., 2020. A study on the variations of recent seismicity in and around the Central Anatolian region of Turkey, *Physics of the Earth and Planetary Interiors* 301, 106453.
- Polat, O., Gok, E., Yılmaz, D., 2008. Earthquake hazard of the Aegean extension region (West Turkey). *Turk. J. Earth Sci.* 17, 593–614.
- Quinlan, J.R. (1987) *Simplifying Decision Trees*. *International Journal of Man-Machine Studies*, 27, 221-234.
- Sharma, R., Ghosh, A., & Joshi, P. (2013). “Decision Tree Approach for Classification of Remotely Sensed Satellite Data Using Open Source Support”. *Journal of Earth System Science*, 122(5), 1237-1247.
- Sikder I.U., Munakata T., 2009. Application of rough set and decision tree for characterization of premonitory factors of low seismic activity. *Expert Syst Appl*, 36:102–10.
- Ural, D. N., Bayrak, M.B., and Saygili, G. (2003). Liquefaction potential assessment by neural networks based on the Kocaeli, Turkey earthquake. *Soil-Dyn. earth. Engr*
- Vapnik, V. (1998). *Statistical learning theory*. Wiley, New York
- Williams CK, Rasmussen CE (2006). *Gaussian Processes for Machine Learning* (Vol. 2, No.3, p. 4). Cambridge, MA: MIT press
- Wu, Y.M., Chiao, Y.L., 2006. Seismic quiescence before the 1999 Chi-Chi, Taiwan, MW7.6 earthquake. *B. Seismol. Soc. Am.* 96 (1), 321–327.

“

Chapter 13

MODIFICATION OF FLY ASH SUPPLEMENTED CEMENT-BASED COMPOSITES WITH NANOMATERIALS

*Hamit ÖZTÜRK¹,
Mahmoud ZIADA²,
Savaş ERDEM³*

”

1 Dr.; Istanbul University – Cerrahpaşa, Department of Civil Engineering. dr.ozturkhamit@gmail.com ORCID No: 0000-0002-9870-4430 (Corresponding author)

2 Dr.; Istanbul University – Cerrahpaşa, Department of Civil Engineering. mahmut.ziada@gmail.com ORCID No: 0000-0003-2986-6759

3 Prof. Dr.; Istanbul University – Cerrahpaşa, Department of Civil Engineering. savas.erdem@iuc.edu.tr ORCID No: 0000-0003-0906-5233

INTRODUCTION

After water, concrete is the second consumption material in the world. the footprint of the cement industry in greenhouse gas emission is about 7% of whole released CO₂ as well as being third energy-consuming industry (N. Anil Kumar Reddy, Kolli Ramujee, 2022), (Ali M. Onaizi, Ghasan Fahim Huseien, Nor Hasanah Abdul Shukor Lim, Mugahed Amran, Mostafa Samadi, 2021). Reusing industrial waste materials like ground-granulated blast furnace slag (GGBFS), silica fume (SF), fly ash (FA) and rice husk ash (RHA) as replacement materials for cement can reduce the level of energy consumption and CO₂ emission and consequently leads to reach sustainability and environmentally requirements. Partially substitution of cement by fly ash improves concrete properties at later ages (after 28 days) and this is due to the pozzolanic reaction of fly ash with Ca(OH)₂ resulting in secondary and more C-S-H gel. But usage of fly causes an increment of porosity and decrement of strength at an early age resulting in non-applied widely in all types of structures. Improvement of cement-based concrete properties by the addition of nanoparticles (NP) has been indicated by several researchers, however, obtained results show high variability and different effects by using the same NPs (Yonathan Reches, Kate Thomson, Marne Helbing, David S. Kosson, Florence Sanchez, 2018) (T. Mendes, D. Hotza, W. Repette, 2015) (P. Aggarwal, R.P. Singh, Y. Aggarwal, 2015) (F. Sanchez, k. Sobolev, 2010) (L.P. Singh, S.R. Karade, S.K. Bhattacharyya, M.M. Yousuf, S. Ahalawat, 2013) (M. Oltulu, R. Şahin, 2011) (J. Moon, M.M.R. Taha, K.-S. Youm, J.J. Kim, 2016) (R. Palla, S.R. Karade, G. Mishra, U. Sharma, L.P. Singh, 2017).

Materials that consist of a particle size of 200nm or less, are defined as nanomaterials. The size of nanoparticles used for the construction materials should be less than 500 nm (M.S. Muhd Norhasri, M.S. Hamidah, A. Mohd Fadzil, 2017). Due to the high specific surface area of nanoparticles, the inclusion of small amounts leads to remarkable changes in the properties of cementitious materials (F. Amor, M. Baudys, Z. Racova, L. Scheinherova, L. Ingrisova, P. Hajek, 2022) (B. Han, S. Ding, J. Wang, J. Ou, 2019) (L. Raki, J. Beaudoin, R. Alizadeh, J. Makar, T. Sato, L. Raki, J. Beaudoin, R. Alizadeh, J. Makar, T. Sato, 2010). The efficiency of nanomaterials in cement base concretes can be described in two ways; first, to stimulate nucleation reactions during the cement hydration phase and second, to react with cement components in the pozzolanic reaction forms resulting in the production of more C-S-H gel (Gerrit Land, Dietmar Stephan, 2015) (Jo B, Kim C, Tae G, Park J., 2007) (Thomas JJ, Jennings HM, Chen JJ., 2009). As nanomaterials which are smaller than cement particles are employed to concrete matrix, these new binding agents refine hydration gel and result in neat and solid hydration composite (M.S. Muhd Norhasri, M.S. Hamidah,

A. Mohd Fadzil, 2017) (A.K.M. Bjorn Birgisson, Georgene Geary, Mohammad Khan, Konstantin Sobolev, 2012) (S. Zhao, W. Sun, 2014).

The outstanding purpose of the nanoparticles employment in concrete is to enhance compressive strength and durability at an early age. The porosity of concrete matrix is the most important factor for durability and longevity of cement-base concrete. Previous studies have proved that nanomaterials assist in the reduction of porosity by absorption of less water in comparison to conventional materials (Terlumun Utsev, Toryila Michael Tiza, Onyebuchi Mogbo, Sitesh Kumar Singh, Ankit Chakravarti, Nagaraju Shaik, Surendra Pal Singh, 2022) (S. Du, J. Wu, O. AlShareedah, X. Shi, 2019) (A.G. Mehairi, M.M. Husein, 2020). Other beneficial outcomes of nanomaterials' utility are self-cleaning properties, electrical conductivity, self-repair capacity, and frost resistance enhancement (F. Amor, M. Baudys, Z. Racova, L. Scheinherrova, L. Ingrisova, P. Hajek, 2022). Kaur et al. indicated that the addition of nano metakaolin to fly ash-cement concrete could increase strength at an early age (M. Kaur, J. Singh, M. Kaur, 2018). Gunasekara showed that adding 3% nano-silica to high-volume FA blended concrete can enhance compressive strength at the age of 7 and 28 days (Ch. Gunasekara, M.Sandanayake, Zh.Zhou, D. W.Law, S.Setunge, 2020). Li et al. proved that employment of 2% nano TiO₂ to OPC concrete developed compressive strength by 18.5% after 28 days of curing (Ali M. Onaizi, Ghasan Fahim Huseien, Nor Hasanah Abdul Shukor Lim, Mughed Amran, Mostafa Samadi, 2021) (Zh. Li, B. Han, Xun Yu, S. Dong, L. Zhang, X. Dong, J. Ou, 2017).

This study investigates the effect of the addition of 1% NA, NT, or NC to fly ash-cement concrete in which 20% of cement was replaced by Type F fly ash.

MATERIALS AND METHOD

CEM I 42.5 was used as base binder and 20% of cement was replaced by type F fly ash. Designed water/binder ratio was 0.45 and Polycarboxylic ether-based MasterGlenium SKY 608 was applied as super plasticizer at the rate of 1.47% of water by the weight. Nano materials were added to mixtures by 1% of cement weight. Cube specimens of 50x50x50 mm were molded to carry out ultrasonic pulse velocity and compressive strength tests. Flexural strength test was executed on 40x40x160 mm prisms. All specimens were demolded after 24 hours, thereafter, were cured at 95% relatively moisture at ambient temperature for 28 days. Sample names and mixture proportions have been given in Table 1.

Table 1: Denotation and mix proportions of mortars

Sample name	Cement (kg/m ³)	Water (Kg/m ³)	Sand (Kg/m ³)	Fly Ash (Kg/m ³)	Nano Al ₂ O ₃ (Kg/m ³)	Nano TiO ₂ (Kg/m ³)	Nano CaCO ₃ (Kg/m ³)	Super Placticizer (Kg/m ³)
CM	585	263.6	1757	-	-	-	-	3.89
FM	585	263.6	1757	117	-	-	-	3.89
FMNA	585	263.6	1757	117	5.85	-	-	3.89
FMNT	585	263.6	1757	117	-	5.85	-	3.89
FMNC	585	263.6	1757	117	-	-	5.85	3.89

RESULTS

Ultrasonic Pulse Velocity (UPV)

As shown in Fig.1, replacing cement with 20% fly ash decreased UPV by 6.5% in comparison to control concrete mortar. The addition of NA and NT to fly ash-cement mortars enhanced the UPV by 2.74% and 1.15% respectively. The lowest UPV was related to fly ash-cement mortars with NC. UPV is directly in correspondence with the microstructure and porosity of the mixture matrix.

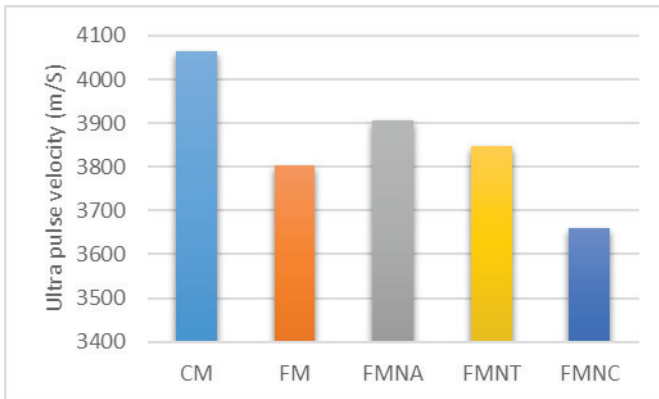

Figure 1. UPV transmission speed of samples at 28 days.

Scanning Electron Microscopy (SEM)

Scanning electron microscopy images of samples are shown in Figs. 2-6 and the microstructure of samples was studied. Replacement of 20% of cement by fly ash increased the porosity of the mortar matrix (Fig. 3). It is due to the reduction of produced C-S-H gel and not starting of pozzolanic reaction at the early age which led to make the structure more porous. The introduction of NA and NT to fly ash-cement mortars declined the porosity of mixtures and made the matrix much denser than FM samples (Figs. 4-5). The addition of NC to the mixture did not improve the structure porosity (Fig. 6). SEM images of specimens confirmed the obtained results by UPV tests based on the microstructural behavior of the mixtures matrix.

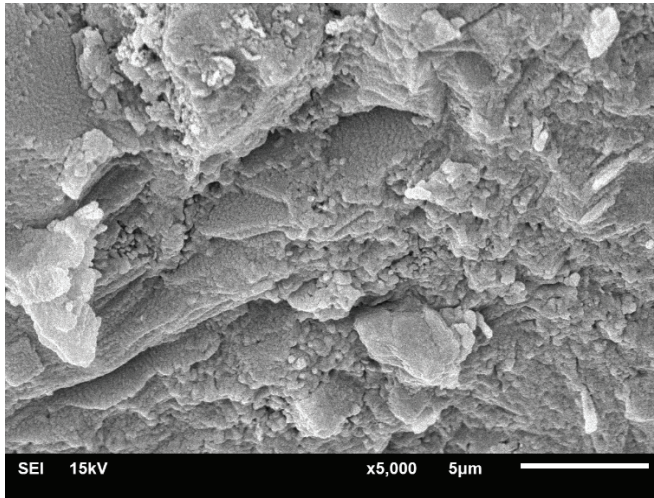

Figure 2. SEM image of cement mortar (CM).

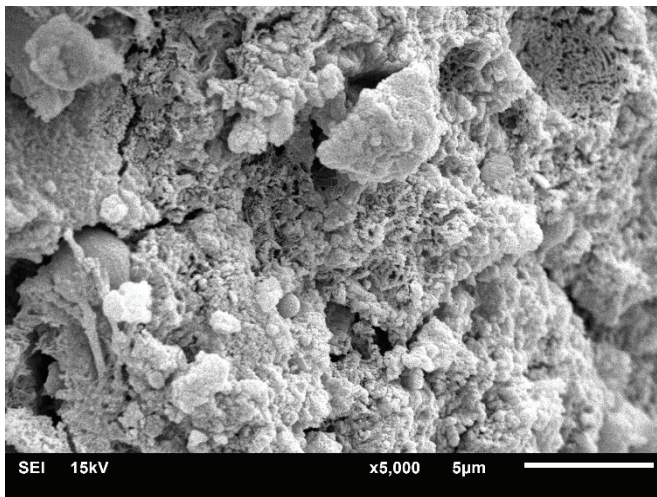

Figure 3. SEM image of fly ash-cement mortar (FM).

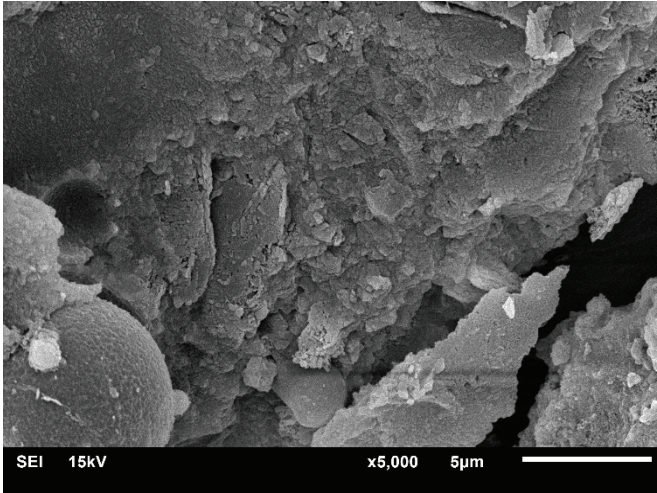

Figure 4. SEM image of fly ash-cement mortar with NA (FMNA).

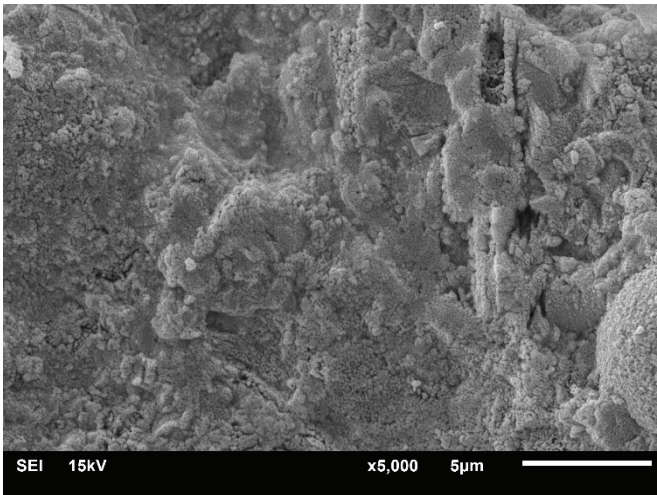

Figure 5. SEM image of fly ash-cement mortar with NT (FMNT).

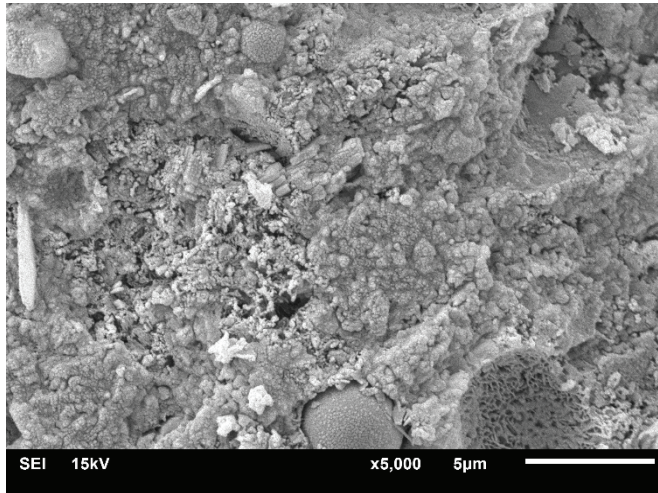

Figure 6. SEM image of fly-ash cement mortar with NC (FMNS).

Compressive strength

Compressive strength tests were applied on 50x50x50 mm cube mortars according to TS-EN 12390-3 at the loading rate of 1000 ± 100 N/s and obtained results have been given in Fig. 7. 20% substitution of cement by fly ash diminished strength from 45.09MPa to 30.1MPa by 33% loss at 28 days. Fundamentally, it is due to the increment of porosity caused by fly ash substitution. The addition of NA, NT, and NC to fly ash-cement mortars enhanced strength by 20%, 21%, and 7%, respectively. The inclusion of nanomaterials in mortars increases the hydration rate at an early age leading to producing more C-S-H and lower porosity.

Flexural strength

Mortar prisms of 40x40x160 mm were examined for flexural strength according to TS-EN12390-5 using a three-point bending test and the loading rate was 40 N/s, results are shown in Fig. 8. Similar to compressive results, the replacement of cement by fly ash decreased flexural strength by 12% from 3.7 MPa to 3.25. By adding NA and NT to fly ash-cement mortars flexural strength increased by 5% and 9.5% respectively to 3.4 MPa and 3.56 MPa. The employment of NC did not improve flexural strength and even lowered it by 3%. This negative effect of NC is due to its lower reactivity and agglomeration of nanoparticles.

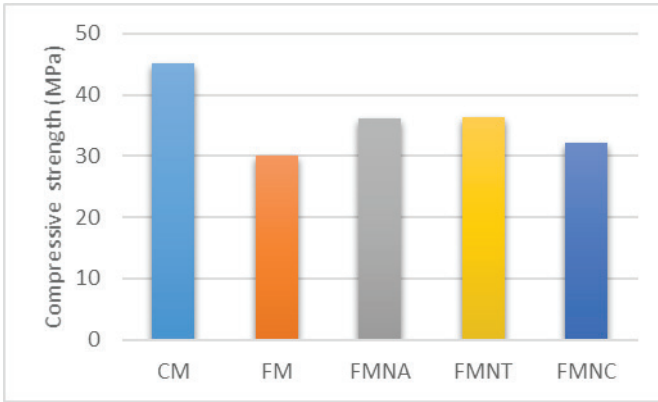

Figure 7. Compressive strength of cube mortars at 28 days.

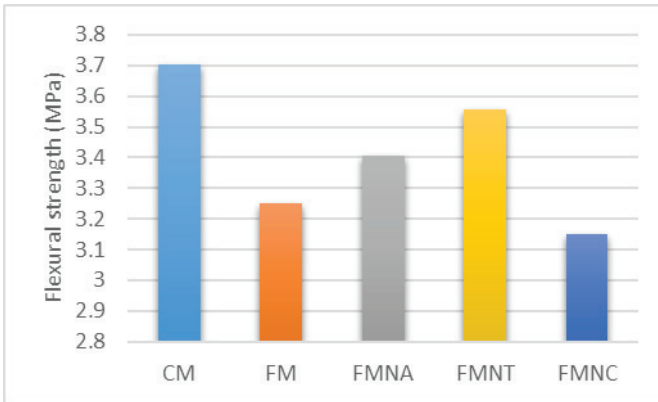

Figure 8. Flexural strength of prisms mortars at 28 days.

DISCUSSION

Fly ash-cement mortars (FM): Replacement of cement by mineral additives like fly ash means a reduction in cement content and consequently decrement in cement hydration productions as C-S-H which supplies concrete strength. On the other hand, the chemical properties of fly ash cause to lower hydration rate, and also morphological properties decrease the water demand of concrete and this leads to an increment of porosity at an early age which will be improved at a later age by continuing pozzolanic reaction. But strength loss of fly ash-cement composites at an early age is a very important issue. Obtained results contributed to a study done by Hamit, in which 20% percent of cement was replaced by fly ash, and the properties of composites were investigated after 28, 56, and 90 days (Hamit Öztürk, F.M. Kılınçkale, 2022).

Nanomaterials: Nanoparticles with high specific areas promote chemical-pozzolanic reactions in concrete mixtures and accelerate hydration rate and enhance mechanical properties at an early age. On the other hand, the inclusion of nanomaterials in concrete composites inhibits $\text{Ca}(\text{OH})_2$ leaching which is responsible for concrete deterioration. Nanomaterials consume existing $\text{Ca}(\text{OH})_2$ to complete the pozzolanic reaction and produce secondary C-S-H gel in favor of increment of strength and reduction of binder porosity. Furthermore, morphological attributes of nanoparticles improve the interfacial zone between cement and aggregates and also act as super fillers leading to a reduction of porosity and enhancement in density and bulk packing. (Ali M. Onaizi, Ghasan Fahim Huseien, Nor Hasanah Abdul Shukor Lim, Mugahed Amran, Mostafa Samadi, 2021) (M. H.Beigia, J. Berenjjan, O.L. Omrana, A. S. Nik, I. M.Nikbin, 2013) (M. Amran, S. Debbarma, T. Ozbakkaloglu, 2021). There are a few pieces of research in the field of nanomaterials added to fly ash-cement composites, however, obtained results are compared to existing studies as much as possible.

Nano Al_2O_3 : The obtained results showed an enhancement of 20% in compressive strength in FMNA that was accomplished with indicted results by Mohseni et al, in which the addition of 1% NA to fly ash-cement concrete increased strength by 15% (Ehsan Mohseni, Konstantinos Daniel Tsavdaridis, 2016). Also, Vanitha et al and Shaikh et al reported an improvement of 16-32% in compressive strength (N. Vanitha, T. Revathi, R. Gopalakrishnan, R. Jeyalakshmi, 2021) (Faiz Uddin Ahmed Shaikh, Anwar Hosan, 2019). Due to the pozzolanic reaction of NA, portlandite ($\text{Ca}(\text{OH})_2$) is absorbed by nanoparticles and forms a new C-S-(A)-H gel which refines capillaries and reduces porosity. The effect of this mechanism on density was observed in the UPV test result with increment of 2.74%. FMNA showed an increase of 5% in flexural strength which contributed to Vanitha et al results (N. Vanitha, T. Revathi, R. Gopalakrishnan, R. Jeyalakshmi, 2021).

Nano TiO_2 : Li et al and Moro et al indicated that the addition of NT to mixtures enhanced compressive strength by 18.5 % and 15.3%, respectively (Ali M. Onaizi, Ghasan Fahim Huseien, Nor Hasanah Abdul Shukor Lim, Mugahed Amran, Mostafa Samadi, 2021) (Carlos Moro, Vito Francioso, Mirian Velay-Lizancos, 2021). Vanitha et al observed inclusion of 2% NT in fly ash-cement mixtures increased compressive strength by 26.7% at 90 days (N. Vanitha, T. Revathi, R. Gopalakrishnan, R. Jeyalakshmi, 2021). Obtained result of a 21% improvement in compressive strength in this study was in agreement with mentioned studies. A very high hydration rate of NT particles raises combined chemical water content, in return mass of unbound water declines, and thus capillary adsorption decreases. There-

fore, the addition of NT makes the mixture denser and lowers the porosity. Vanitha showed that usage of 2 and 4% of NT decreased the capillarity of fly ash-containing samples after 28 days by 4.5% and 7.5%, respectively, which confirms obtained result of the UPV test in this study. As for flexural strength, NT improved strength by 9.5%, but because of the existing gap in this experiment, it could not be compared with other research.

Nano $CaCO_3$: Employment of NC in fly ash-cement mortars showed mild improvement in compressive strength by 7% and other researchers indicated that incorporation of NC to cement base composites increased compressive strength (T. Sato, F. Diallo, 2010) (X. Liu, L. Chen, A. Liu, X. Wang, 2012). The addition of 1 % of NC to fly ash-cement mortars did not affect UPV and flexural strength positively. However, this issue can be described by the agglomeration of nanoparticles. Agglomeration disrupts the uniformity of nanoparticles dispersion and hampers them to incorporate CH to complete the pozzolanic reaction, and thus more C-S-H gel can not be produced. Also, agglomeration weakens the interfacial transition zone between aggregate and binder which leads to lower adherence between particles (Yogiraj Sargam, Kejin Wang, 2021).

CONCLUSION

The main purpose of this study is to spread out the substitution of cement content by mineral additives like fly ash in the structures that early age is needed basically. The addition of nanoparticles can improve mechanical properties at an early age. Among the used nanomaterials in this study, the best enhancement was related to nano TiO_2 followed by nano Al_2O_3 . The addition of nano $CaCO_3$ by 1% was not effective on mortar properties and to find the optimal amount more investigated is required. Since various nanomaterials have different physical and chemical properties, they can improve the properties of structures from different aspects. Therefore, the inclusion of two or three nanomaterials in binary or ternary mixtures can be more successful and functional.

REFERENCES

- A.G. Mehairi, M.M. Husein. (2020). Enhancement of cement properties by means of in situ grown nanoparticles. *Construction and Building Materials*, 261, 120496.
- A.K.M. Bjorn Birgisson, Georgene Geary, Mohammad Khan, Konstantin Sobolev. (2012). *Nanotechnology in Concrete Materials*. Transportation Research Circular E-C170.
- Ali M. Onaizi , Ghasan Fahim Huseien, Nor Hasanah Abdul Shukor Lim, Mughahed Amran, Mostafa Samadi. (2021). Effect of nanomaterials inclusion on sustainability of cement-based concretes: A comprehensive review. *Construction and Building Materials*, 306(124850).
- B. Han, S. Ding, J. Wang, J. Ou. (2019). *Nano-Engineered Cementitious Composites, Principles and Practices*. Singapor: Springer.
- Carlos Moro, Vito Francioso, Mirian Velay-Lizancos. (2021). Impact of nano-TiO₂ addition on the reduction of net CO₂ emissions of cement pastes after CO₂ curing. *Cement and Concrete Composites*, 123, 104160.
- Ch. Gunasekara, M.Sandanayake, Zh.Zhou, D. W.Law, S.Setunge. (2020). Effect of nano-silica addition into high volume fly ash–hydrated lime blended concrete. *Construction and Building Materials*, 253, 119205.
- Ehsan Mohseni, Konstantinos Daniel Tsavdaridis. (2016). Effect of Nano-Alumina on Pore Structure and Durability of Class F Fly Ash Self-Compacting Mortar. *American Journal of Engineering and Applied Sciences*, 9(2), 323-333.
- F. Amor, M. Baudys, Z. Racova, L. Scheinherrova , L. Ingrisova, P. Hajek. (2022). Contribution of TiO₂ and ZnO nanoparticles to the hydration of Portland cement and photocatalytic properties of High Performance Concrete. *Case Studies in Construction Materials*, 16, e00965.
- F. Sanchez, k. Sobolev. (2010). Nanotechnology in concrete – A review. *Construction and Building Materials*, 24(11), 2060-2071.
- F. Uddin Ahmed Shaikh, Anwar Hosan. (2019). Effect of Nano Alumina on Compressive Strength and Microstructure of High Volume Slag and Slag-Fly Ash Blended Pastes. *Frontiers in Materials*, 6(90).
- Gerrit Land, Dietmar Stephan. (2015). Controlling cement hydration with nanoparticles. *Cement & Concrete Composites*, 57, 64-67.
- H. Öztürk, F.M. Kılınçkale. (2022). The effect of wetting-drying / freezing-thawing cycles on properties of non-air entrained fly ash substituted cement-based composites. *Ceramics International*. doi:<https://doi.org/10.1016/j.ceramint.2022.11.294>
- J. Moon, M.M.R. Taha, K.-S. Youm, J.J. Kim. (2016). Investigation of Pozzolanic Reaction in Nanosilica-Cement Blended Pastes Based on Solid-State Kinetic Models and ²⁹Si MAS NMR. *Materials*, 9(2), 99.

- Jo B, Kim C, Tae G, Park J. (2007). Characteristics of cement mortar with nano-SiO₂ particles. *Construction and Building Materials*, 21(6), 1351-1355.
- L. Raki, J. Beaudoin, R. Alizadeh, J. Makar, T. Sato, L. Raki, J. Beaudoin, R. Alizadeh, J. Makar, T. Sato. (2010). Cement and Concrete Nanoscience and Nanotechnology. *Materials*, 3(2), 918-942.
- L.P. Singh, S.R. Karade, S.K. Bhattacharyya, M.M. Yousuf, S. Ahalawat. (2013). Beneficial role of nanosilica in cement based materials – A review. *Construction and Building Materials*, 47, 1069-1077.
- M. Amran, S. Debbarma, T. Ozbakkaloglu. (2021). Fly ash-based eco-friendly geopolymer concrete: A critical review of the long-term durability properties. *Construction and Building Materials*, 27, 121857.
- M. H. Beigia, J. Berenjian, O.L. Omrana, A. S. Nik, I. M.Nikbin. (2013). An experimental survey on combined effects of fibers and nanosilica on the mechanical, rheological, and durability properties of self-compacting concrete. *Materials & Design*, 50, 1019-1029.
- M. Kaur, J. Singh, M. Kaur. (2018). Microstructure and strength development of fly ash-based geopolymer mortar: Role of nano-metakaolin. *Construction and Building Materials*, 190, 672-679.
- M. Oltulu, R. Şahin. (2011). Single and combined effects of nano-SiO₂, nano-Al₂O₃ and nano-Fe₂O₃ powders on compressive strength and capillary permeability of cement mortar containing silica fume. *Materials Science and Engineering: A*, 528(22-23), 7012-7019.
- M.S. Muhd Norhasri, M.S. Hamidah, A. Mohd Fadzil. (2017). Applications of using nano material in concrete: A review. *Construction and Building Materials*, 133, 91-97.
- N. Anil Kumar Reddy, Kolli Ramujee. (2022). Comparative study on mechanical properties of fly ash & GGBFS based geopolymer concrete and OPC concrete using nano-alumina. *Materials Today: Proceedings*, 399-404.
- N. Vanitha, T. Revathi, R. Gopalakrishnan, R. Jeyalakshmi. (2021). Effect of TiO₂, Al₂O₃ and CaCO₃ nano-additives in singular, binary and ternary forms on the mechanical, thermal and microstructural properties of fly ash supplemented cement matrix. *Materials Today: Proceedings*, 47, 871-879.
- P. Aggarwal, R.P. Singh, Y. Aggarwal. (2015). Use of nano-silica in cement based materials—A review. *Cogent Engineering*, 2(1), 1078018.
- R. Palla, S.R. Karade, G. Mishra, U. Sharma, L.P. Singh. (2017). High strength sustainable concrete using silica nanoparticles. *Construction and Building Materials*, 138, 285-295.
- S. Du, J. Wu, O. AlShareedah, X. Shi. (2019). Nanotechnology in Cement-Based Materials: A Review of Durability, Modeling, and Advanced Characterization. *Nanomaterials*, 9(9), 9091213.
- S. Zhao, W. Sun. (2014). Nano-mechanical behavior of a green ultra-high perfor-

- mance concrete. *Construction and Building Materials*, 63, 150-160.
- T. Mendes, D. Hotza, W. Repette. (2015). Nanoparticles in cement based materials: A review. *Rev. Adv. Mater. Sci.*, 40, 89-96.
- T. Sato, F. Diallo. (2010). Seeding effect of nano-CaCO₃ on the hydration of tricalcium silicate. *Transportation Research Record: Journal of the Transportation Research Board*, 2141(1), 61-67.
- Terlumun Utsev, Toryila Michael Tiza, Onyebuchi Mogbo, Sitesh Kumar Singh, Ankit Chakravarti, Nagaraju Shaik, Surendra Pal Singh. (2022). Application of nanomaterials in civil engineering. *Materials Today: Proceedings*, 62(8), 5140-5146.
- Thomas JJ, Jennings HM, Chen JJ. (2009). Influence of Nucleation Seeding on the Hydration Mechanisms of Tricalcium Silicate and Cement. *The Journal of Physical Chemistry C*, 113(11), 4327-4334.
- X. Liu, L. Chen, A. Liu, X. Wang. (2012). Effect of Nano-CaCO₃ on Properties of Cement Paste. *Energy Procedia*, 16, 991-996.
- Yogiraj Sargam, Kejin Wang. (2021). Hydration kinetics and activation energy of cement pastes containing various nanoparticles. *Composites Part B*, 216, 108836.
- Yonathan Reches, Kate Thomson, Marne Helbing, David S. Kosson, Florence Sanchez. (2018). Agglomeration and reactivity of nanoparticles of SiO₂, TiO₂, Al₂O₃, Fe₂O₃, and clays in cement pastes and effects on compressive strength at ambient and elevated temperatures. *Construction and Building Materials*, 167, 860-873.
- Zh. Li, B. Han, Xun Yu, S. Dong, L. Zhang, X. Dong, J. Ou. (2017). Effect of nano-titanium dioxide on mechanical and electrical properties and microstructure of reactive powder concrete. *Materials Research Express*, 4(9), 095008.

“

Chapter 14

**USING BLENDED LEARNING IN
TEXTILE ENGINEERING EDUCATION,
AN EXAMPLE OF INTERNSHIP CLASS**

Memik Bunyamin UZUMCU¹,

Tuba BEDEZ UTE²

”

1 Gaziantep University, Department of Textile and Fashion Design, ORCID: 0000-0002-5741-1199

2 Ege University, Department of Textile Engineering, ORCID: 0000-0003-0574-2874

1. Introduction

In the computer and information ages we live in, it is impossible to leave computers and its applications out of education. Especially, Engineering students are the ones who are expected to master computational skills. Generally, basic computer using skills are given to students before higher education. They mostly learn computer applications which they use in their professions in higher education.

In these days, most of the educators complain about students' lack of focus on the lessons. Moreover; social media, games etc. additionally prevent students to focus on their education even in their classes. There are unfortunately hundreds or more social media platforms they feel obliged to use. We won't argue ethical concerns or social effects of them. On the contrary, in this study we tried to benefit from them. In order to accomplish this, we used blended learning as our instruction method.

Blended learning is a blend of traditional education and technology mediated instruction (Graham, Woodfield, & Harrison, 2013). It is also defined as "classroom seat time being replaced with online instruction" (Graham, 2015; Graham et al., 2013; Picciano, 2009). So, it is basically changing some of the classroom hours with hours spent with computers for students. There are studies on the use of this Instruction system in higher education. Lopez-Perez et al. found out in their study that using blended learning had a positive effect in improving exam results of students (López-Pérez, Pérez-López, & Rodríguez-Ariza, 2011). Porter et al studied implementing blended learning to institutions and recommended providing adequate technical and pedagogical support for both teachers and students (Porter, Graham, Spring, & Welch, 2014). Moreover, Spanjers et al indicated that quizzes positively affects effectiveness and attractiveness of blended learning (Spanjers et al., 2015). It was also indicated that with good planning and support, blended learning could result in positive institutional transformation (Moskal, Dziuban, & Hartman, 2013).

There are studies about improving education for textile engineering students. Farr et al. studied using Multimedia and Problem-based instruction in textile laboratory lessons. They have concluded their study as: using problem-based instruction and multimedia experiences provided variety which contributed to learning experience (Farr, Ownbey, Branson, Cao, & Starr, 2005). Okur et al. 's study focused on determining textile engineering students' needs and opinions of their education by using Quality Function Deployment (QFD) with Ordered Weighted Averaging (OWA) aggregation technique (Ayşe Okur, Nasibov, Kiliç, & Yavuz, 2009). They also had done a situation analysis with with a survey they made for the graduates of textile engineering and made suggestions for the development

of this education according to the result of this analysis (A. Okur, Kaplan, Sular, & Kılıç, 2007). Sayer and Studd's work on learning styles of textile and design students in The University of Manchester and Manchester Metropolitan University indicated that students' biases leaned towards teaching styles which include laboratory classes and practical design projects. But they also indicated that suitable teaching style is different for each student, so broad range of teaching styles should be utilized (Sayer & Studd, 2006). Using blended learning can be the answer in terms of "broad range of teaching styles".

In this study, we have investigated the effects of blended learning on the textile engineering students' academical success. For this purpose, we have used some applications, such as univeristy's own distance education platform which was first utilized in the pandemic period and Kahoot in the learning process. We have sent educational videos about machinery and data about our classes before the lessons using distance education platform and asked students to examine them. Moreover, Kahoot was used for quick quizzes during the lessons to determine students' comprehension levels of the lesson. In conclusion, we have analyzed the effect of blended learning on students via qualitative and quantitative analysis.

2. Method

In Textile Engineering department, there is a mandatory internship course for undergraduate students, which is given after 2nd year of their education. This internship includes classes about basic textile engineering branches such as spinning, knitting and weaving. As a part of this internship programme, students initially attend classes about textile systems and their machinery. After that, they take a verbal exam.

In this internship programme we used blended learning and traditional face to face learning for comparison. These groups were named as "F2F" and "Blended". Education time of these two groups was one week for each group. Comparison between the groups was carried out with statistical analysis of verbal test results, in order to determine blended learning's effect. On the other hand, we have asked students belong to "Blended" group to write an essay about their internship education which should include answers to three questions. These questions were: "Is it beneficial to do internship in this way?", "Does it provide permanent learning?" and "Do you recommend that other lessons should be taught like this?". Descriptive analysis was used to examine the essays of students. Ultimately, we utilized mixed design to analyze the efficiency of the instruction method we used. Mixed design which is mostly used nowadays was used for empowering the method of the study. Designs which include qualitative and quantitative studies have functions like confirming, detailing and revealing

different aspects of data gathered with quantitative method (Greene, Caracelli, & Graham, 1989). Qualitative research is the type of research in which data is gathered directly from the source, not only the result but also process is valued and inductive approach is embraced (Büyüköztürk, Kılıç Çakmak, Erkan Akgün, Karadeniz, & Demirel, 2016).

Kahoot is a web based application which can be used to create and make quizzes. Person who is going to create the quiz signs in the web page (Figure 2). Quiz preparation is simple and practical with this web page. Students can download the application and enter the quiz by using the pin code given by the teacher. Questions appear on teacher's computer which is projected on a screen for students to see. Each answer is coded with a different symbol and color and given below the question on the teacher's screen. Students use their cellphones or computers on which these answer codes and colors can be seen. Time limit of each question is identified by the teacher. After the time given for the question, a page opens with a list of the correct answer givers and their points which are determined by their response time.

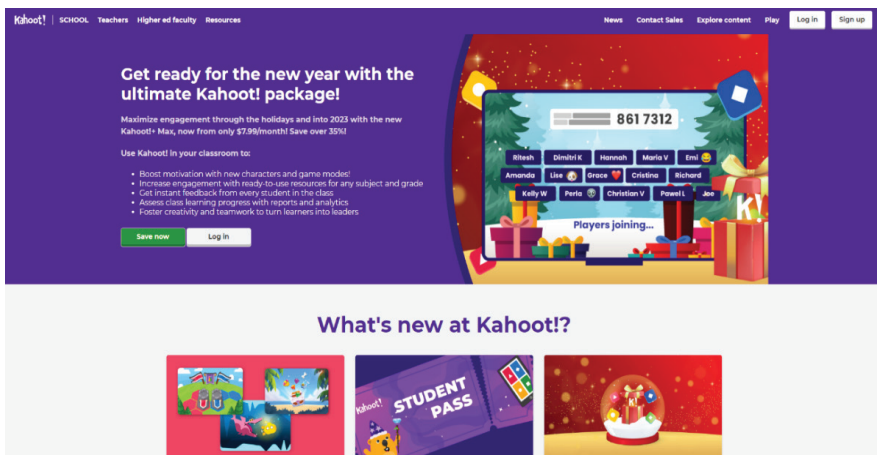

Figure 2. Kahoot Official Page for creating quizzes (<https://kahoot.com>)

Verbal exam which we used was created by 3 professors, who are experts in their fields of study. The exam consisted of 6 types of questions which are given in Table 1. Each type included 6-10 equivalent questions which are given in appendix 1. Each student was subjected to one question from each category. Total result of the verbal exam was set at 100 and some categories had different points than other (Table 1).

Table 1. Verbal Exam Questions

Question	Category	Maximum Point
1	Workflow	20 pts
2	Functions of machinery	15 pts
3	Parts of machinery	15 pts
4	Raw material properties	15 pts
5	Product properties	15 pts
6	Spinning system comparisons	20 pts

Quantitative evaluation part of this study was carried out by using SPSS statistics software. For this evaluation, the results of two groups were gathered and Paired sample T test was used to determine if there is a statistically significant difference between the “F2F” and “Blended” groups or not. Results of this test and the results of Kahoot quizzes as further information are given in results part of this study.

3. Results

In this study, mixed method was used to analyze the effect of blended learning on students. The results of quantitative and qualitative analyses are presented in sub-titles.

a. Quantitative analysis

As mentioned before, we used two groups in this study: “F2F” group was taught conventionally (face to face), and “Blended” group was taught using blended learning. Each group had one week of education in their internship programme. After this period, they were subjected to the same verbal exam which was created by 3 professors who are experts in their field of studies. The results of this verbal exam were gathered and evaluated using Paired sample t test.

Verbal test mean results of students belonging to “pre blended” and “post blended” groups were 76,02/100 and 82,65/100, respectively. Results show us that “post blended” group students got higher points in their exams than “pre blended” group students. Moreover, the difference between these two groups is statistically significant according to paired sample t test. The result of paired sample t test is given on table 2.

Table 2. Paired sample t test result

Groups	N	Sig. (2-tailed)
F2F – Blended	22/22	0,028

Students also were subjected to quizzes during classes. It was impressive to see their excitement during the quizzes, because this application is

easy to use and also entertaining to the students. We prepared and executed four quizzes during the week. The results of the quizzes are given on Table 4. However, Kahoot was only used for “Blended” group.

Table 3. Kahoot Results

Quiz No	%Total Correct	% Total Incorrect	How fun was it?	Did You Learn Something?	Do You Recommend it?	How Do You Feel?
1	55	45	5	1	1	Pos: 0,857
						Neg:0
						Neu: 0,142
2	83	17	4,4	1	1	Pos: 0,95
						Neg:0
						Neu: 0,05
3	84	16	4,5	1	1	Pos: 0,89
						Neg:0
						Neu: 0,11
4	76	24	4,5	1	1	Pos: 0,83
						Neg:0
						Neu: 0,17

Kahoot also questions students about their opinions on the application. These questions and the reaction of the students are given on table 4. Students told that they had fun using the application (min 4,4 /5), they learnt something and they recommend it. Their feelings about the application was mostly positive (min 0,83).

b. Qualitative analysis

Students were asked to evaluate the process after the class. Students sent their views via e-mail. Descriptive analysis which is mostly used in qualitative analysis was used to analyze these views. Descriptive analysis aims to reveal opinions of interviewed or observed individuals (Yıldırım & Şimşek, 2013). This analysis consists of four stages. In the first stage, it is determined that which theme will be used to organize data. In the second stage, parts of data are splitted from each other as if they are suitable or not suitable to the theme. In the third stage, data is supported directly with quotes while being attentive to the repetition. In the last stage, data which fits the themes are interpreted and explained.

In light of these informations, 3 themes were determined, which were;

- (1) Benefit of the method,
- (2) It's contribution to permanent learning,

(3) Recommendation of the method.

Results are as follows:

1st theme “Benefit of the method”

All of the students found this instruction method beneficial and fun. They expressed their appreciation. Some of their opinions about Kahoot were:

- “It was interesting that a different method was used during our education. The application used for determining our comprehensive levels was funny and really good.”
- “In my opinion, using fun instruction methods always Works for people from all ages. It was a fantastic way to make mandatory internship interesting.”
- “Kahoot is a funny quiz application. It strengthened what we have learned.”

2nd theme “It’s contribution to permanent learning”

There are two situations, students emphasized in this theme. First one is, materials about class being in distance education platform and its communication providing and the other one is questions asked with Kahoot during the classes being strengthening.

- “... your supporting with videos, photos and other materials you shared let persistency of the knowledge we have learned. We watched the videos when we needed better understanding of the machinery and the systems.”
- “The things we have learned are remembered easily, you think “I have answered wrong about this thing in the class and because of it I missed being the first one.” and this is one of the things that allows you not to forget easily.”
- “Doing internship classes this way let us learn stuff about the class before the class and this led us to comprehend much more easily. Moreover, Kahoot quizzes strengthened our knowledge and make it persistent. Quick explanation after our every wrong answer allowed us to improve our knowledge.”
- “For example, I have learned practically in this internship and this will help me in my undergraduate studies.”
- “By watching of the videos about the machinery and the systems, after that being taught in the classroom and then answering questions about what we learned let us have a persistent knowledge and I don’t think I will ever forget them.”

3rd theme “Recommendation of the method”

Most of the students had a positive opinion about blended learning. They have concluded their statements as an answer to the last question with their recommendation of this instruction method.

- “In my opinion every class can be taught like this, however we all should understand for what we use technology and every teacher should know how to use it.”

- “I want to be taught like this in other classes too. Because, classes are fun this way and we are more competitive. If they would ask me to take a class I want, I would choose this one ”

- “I recommend that the other classes should be taught like this. At least, Kahoot quizzes raises attention in the classroom.”

- “This is a wonderful way to make classes interesting. This should be used in all of our classes.”

- “I recommend other teacher that they should use distance education platform also. Because, we understand machinery systems better by watching their videos before theoretical lessons.”

4. Discussion

In literature about blended learning, it was generally stated by both educators and students that blended learning has a particularly positive contribution to the learning environment. Also, in our study, students’ positive perceptions, especially about the opportunity to repeat the given information about complex machinery systems in and outside the classroom, support the positive results of the blended learning.

It is evident from the comments that students were satisfied with the use of both applications (distance education platform and Kahoot) in terms of the classroom environment. Blended learning was not specified as a term to the students during the course, but at the end of the course period students were asked to name this instruction method. Incidentally, 8 of the 22 students who participated in this internship named this method as mixed education or blended education and rest of them used similar terms. This indicates that this learning method was understood by the students as a concept.

The results of quantitative analysis show that students who were subjected to blended learning had higher verbal exam results, even in a short period of education time like a week. The positive effect of the blended learning is revealed when it is considered that these students (F2F and blended groups) were admitted to the university with similar university admission exam results and have taken the same courses for two years before

this internship. Student comments given in the qualitative analysis section also support this data.

Some problems also occurred during our training period. These problems were generally technology-based problems. Our quizzes using Kahoot had a need of smartphone and internet. However, some students did not have a smartphone or had a phone but not internet. So, we provided temporary solutions and made them available for these quizzes. Therefore, it is important that these needs have to be met before using this method of instruction.

Further investigation with longer course period is needed to better understand the effects of blended learning on students' success. We need to determine whether the effects seen in this study is like weight loss or not: You lose ten pounds in a week at the start but you cannot keep this rate for the rest of the weight losing period. We need to figure out if the success rate increase is sustainable. For this reason, authors are willing to adjust curriculum of a course which is "Spinning Technologies" according to blended learning. Physical necessities of classroom, for making it available for blended learning will be determined and met before education time.

5. Conclusion

In this study, effects of using blended learning on the success of textile engineering students were investigated. Quantitative and qualitative analysis were done to understand these effects. Quantitative analysis showed that blended learning directly affected student success rate. Students subjected to blended learning scored higher in their verbal examinations. When it is considered that this education had only one-week time, these results were remarkable. Moreover, descriptive analysis reports showed that students were positively affected by this instruction method. Students subjected to blended learning gave all positive feedback about the blended program. They mostly emphasized that they had fun during classes. This was important, because when the classroom time becomes enjoyable, the things the student should learn becomes easier. After the pandemic, the need for distance education became explicit. And the need for higher quality in education forces the lecturers to improve their skills, and broaden their perspective in teaching.

6. Acknowledgements

We would like to thank our students who volunteered for this study and shared their valuable opinions about the instruction method with us.

7. References

- Büyüköztürk, Ş., Kılıç Çakmak, E., Erkan Akgün, Ö., Karadeniz, Ş., & Demirel, F. (2016). Bilimsel araştırma yöntemleri. In *Bilimsel araştırma yöntemleri*. Ankara: Pegem Akademi.
- Farr, C., Ownbey, S., Branson, D., Cao, H., & Starr, C. (2005). Multimedia and problem-based instruction in the textiles laboratory. *Clothing and Textiles Research Journal*, 23(4), 360–367. <https://doi.org/10.1177/0887302X0502300415>
- Graham, C. R. (2015). Emerging Practice and Research in Blended Learning. In M. G. Moore (Ed.), *Handbook of Distance Education* (3rd ed., pp. 333–351). Abingdon: Routledge. <https://doi.org/10.4324/9780203803738.ch21>
- Graham, C. R., Woodfield, W., & Harrison, J. B. (2013). A framework for institutional adoption and implementation of blended learning in higher education. *Internet and Higher Education*, 18, 4–14. <https://doi.org/10.1016/j.iheduc.2012.09.003>
- Greene, J. C., Caracelli, V. J., & Graham, W. F. (1989). Toward a Conceptual Framework for Mixed-Method Evaluation Designs. *Educational Evaluation and Policy Analysis*, 11(3), 255–274. <https://doi.org/10.3102/01623737011003255>
- López-Pérez, M. V., Pérez-López, M. C., & Rodríguez-Ariza, L. (2011). Blended learning in higher education: Students' perceptions and their relation to outcomes. *Computers and Education*, 56(3), 818–826. <https://doi.org/10.1016/j.compedu.2010.10.023>
- Moskal, P., Dziuban, C., & Hartman, J. (2013). Blended learning: A dangerous idea? *Internet and Higher Education*, 18, 15–23. <https://doi.org/10.1016/j.iheduc.2012.12.001>
- Okur, A., Kaplan, S., Sülar, V., & Kılıç, M. (2007). Türkiye’de Tekstil Mühendisliği Eğitimi: Mevcut Durum ve Beklentiler. *II. Tekstil Teknolojileri ve Tekstil Makinaları Kongresi*, 11. Gaziantep. Retrieved from <https://www.researchgate.net/publication/238082427>
- Okur, Ayşe, Nasibov, E. N., Kiliç, M., & Yavuz, M. (2009). Using OWA aggregation technique in QFD: A case study in education in a textile engineering department. *Quality and Quantity*, 43(6), 999–1009. <https://doi.org/10.1007/s11135-008-9170-2>
- Picciano, A. G. (2009). Blending with purpose: The multimodal model. *Journal of the Research Center for Educational Technology*, 5(1), 4–14.
- Porter, W. W., Graham, C. R., Spring, K. A., & Welch, K. R. (2014). Blended learning in higher education: Institutional adoption and implementation. *Computers and Education*, 75, 185–195. <https://doi.org/10.1016/j.compedu.2014.02.011>

- Sayer, K., & Studd, R. (2006). Matching learning style preferences with suitable delivery methods on textile design programmes. *International Journal of Technology and Design Education*, 16(2), 163–176. <https://doi.org/10.1007/s10798-005-4327-y>
- Spanjers, I. A. E., Könings, K. D., Leppink, J., Verstegen, D. M. L., de Jong, N., Czabanowska, K., & van Merriënboer, J. J. G. (2015, June 1). The promised land of blended learning: Quizzes as a moderator. *Educational Research Review*, Vol. 15, pp. 59–74. Elsevier. <https://doi.org/10.1016/j.edurev.2015.05.001>
- Yıldırım, A., & Şimşek, H. (2013). *Sosyal Bilimlerde Nitel Araştırma Yöntemleri*. Ankara: Seçkin Yayınları.

“

Chapter 15

ROLE OF INTERNET OF THINGS IN SUPPLY CHAIN MANAGEMENT

Batin Latif AYLAK¹

”

¹ Dr. Öğr. Üyesi, Türk-Alman Üniversitesi, Mühendislik Fakültesi, Endüstri Mühendisliği Bölümü batin.latif@tau.edu.tr

Introduction

The emergence of supply chain concepts has been observed since the 1980s (Giordano-Spring, S. and Works, S., 2006); the emphasis was on the abolition of old concepts centered on constrained logistics such as transportation and warehousing. Supply chain management is a critical part of innovation in managing materials, information flows, and finances (Sun, W. et al., 2022), from the initial stage of giving raw materials to the supplier to the final delivery to the end consumer. Supply chain management and its 6 stages are provided in the figure below

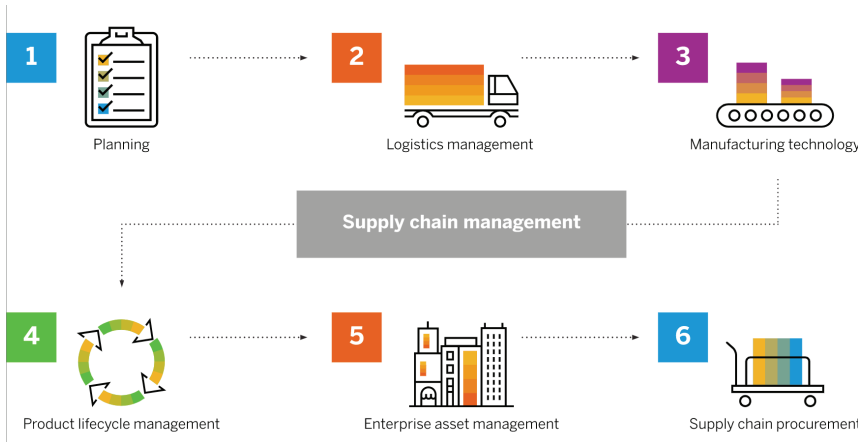

Figure 1 Main components of supply chain management (SAP, 2020)

Supply chain management is a complete package involving management activities for following the products, items, or services in a company or an organization from raw material to manufacturing company, the finished products to distribution, and the final consumer in such a way that the cost gets minimized. (Kothari, S. et al., 2018). As a result, it is accurate to say that supply chain activities cover all facets of the development of product logistics, including tasks related to manufacturing and production, sourcing and transportation, inventory management, warehouse management, and shipping. Over the years, the global supply chain system phone has benefited from lower wages as well as the purchase of inexpensive raw materials from some countries (Kothari, S. et al., 2018). However, the trading system, political uncertainty, global inflation, and technological advancement have altered the business’s dimension, and demand has shifted toward producing sustainable products and delivering such products to customers’ homes via our transportation system. Because of increased industrialization, transparency and data management has become an issue for organizations for which the technology has taken its place in all the

areas of manufacturing, production, transportation, and deliveries.

It is necessary to understand that the reliance on access to data for providing both input and observance of that data at a large scale of the supply chain is unfavorable, which results (Legchekov, S., 2018) in

- Increment of the probability of error which can be observed up to 90% of the spreadsheets
- Manual data extraction may lead to possible delays since the data extraction by the departments its consolidation and integration is a time-consuming procedure
- Manual methods sometimes prove to be an inefficient way of tracking the movement of every product across warehouses and shops. It is difficult for the supply chain manager to track that the product or item has been reached at a defined spot and checked by the employee in accordance with the spreadsheet
- Identification of items of an individual sometimes gets difficult since the production date for the packages or sometimes not placed correctly. This makes it difficult for a company to send the old items being manufactured

The introduction section discussed the supply chain system and the old concepts which require modification by the involvement of the latest technology. In the next section of the literature review, the emphasis has been increased on the challenge faced by the supply chain system for which the role of the Internet of Things has to be realized.

Literature review

The principle of supply chain management is maintaining relationships among the stockholders by developing logical links in structure to achieve overall performance increment. The supply chain system is set for producing the products are providing the services while creating and increasing the values throughout the whole procedure, the basis of which is the achievement of the goal and promotion of the interest. The problem has been faced by small and medium enterprises (SMEs). Another problem that SMEs are following is associated with uncertain planning and forecasting in each stage of the supply chain management which requires management of stocks while avoiding the outage. So, multiple methods such as the "bullwhip effect" (Zhang. Y. and Zheng, W., 2019) are constantly used for the generation of overstock and management of inventory while considering the logistics activities involving planning, controlling, and management activities for materials as well as procedural flows.

However, supply chain management has faced many challenges in

context to technology faced by organizations (Kothari, S. et al., 2018). Some challenges include

- Mismanagement of logistics and transportation
- Improper usage, handling, and storage of data
- Lacking the asset visibility
- Inefficiency in handling the stock
- Improper management of stocks
- Improper risk management for the supply chain system

However, to address these problems and mitigate the bullwhip effect, it is vital to adopt technology that digitalizes everything and aids in cost reduction at every stage of the supply chain system while retaining records and planning for the future.

Internet of Things (IoT)

The Internet of Things is an immersed paradigm that enables the company to get facilitation through a communication system involving sensors and electronic devices. The IoT involves utilizing the Internet and smart devices to provide solutions to multiple challenges in public and private industries, businesses and organizations worldwide. The architecture of IoT has been illustrated in the figure below, which illustrates that intelligent devices, sensors smart systems, and frameworks get interconnected to perform the desired objective. The additional features of storage, processing, and sensing enabled now were impossible before using IoT (Koot, M. et al., 2021).

The IoT has been finding its applications in numerous domains and sectors shown in figure 2. The figure shows that IoT technology can be used in different sectors of energy, education, medical science, industry, and others for several purposes. However, the main requirement is to connect the technologies together along with the analytics and management of the data and security so that the data breach can be avoided. This concept of network of networks, shown in figure 2, requires integration by using smartphones, cameras, sensing applications, and information flow using the Internet. Without relying on the size and functionalities of the systems, it is possible to accomplish the positioning, reorganization, dressing, and monitoring of the procedure along with control. A substantial advancement has been noted in the field of electronics involving wearable gadgets such as watches and headsets, which connect individuals by associating with the digital and physical worlds. Now, some applications of the Internet of Things shall be observed for different sectors (Miraz, M. et al., 2018).

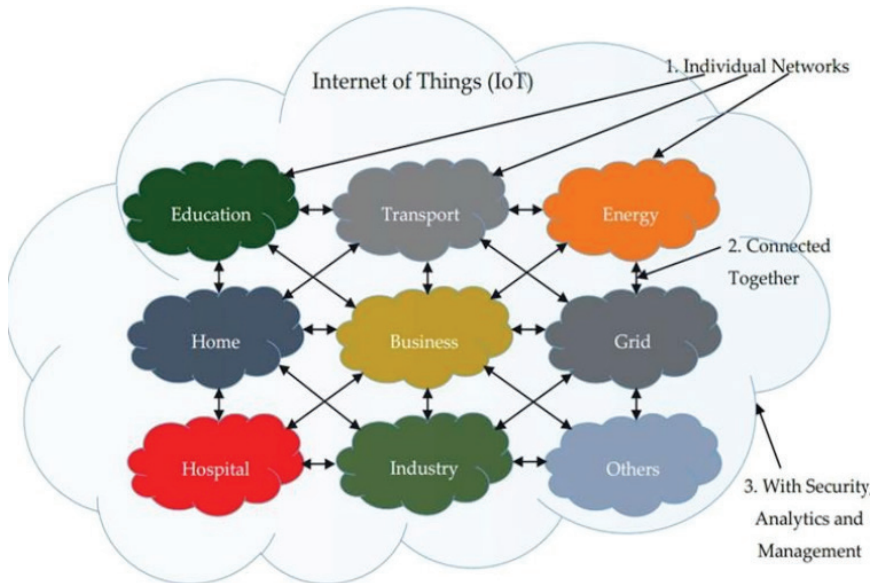

Figure 2 Applications of IoT in different sector (Miraz, M. et al., 2018)

The applications of IoT in different sectors depend upon nature and must be addressed in such a way as to observe the role of IoT in each sector distinctively.

Smart cities

The researchers find the applications of IoT to be crucial in developing and managing smart cities with large infrastructures (Zanjali, S. and Talmale, G., 2016). When it comes to a smart city, then the observation shows that the main sectors of smart buildings, smart transportation systems, smart mapping, management of waste, and traffic management make the cities smart and sustainable. It involves multiple functions, such as recording the available parking spaces in different locations of the city, monitoring the vibrations of the buildings and bridges, and placement of monitoring devices in the sensitive locations of the city move. Therefore, the IoT finds its application in smart cities by utilization of sensors and radio frequency identifiers.

Smart Water management system and Agriculture

The IoT provides the capability of enhancing and strengthening the agricultural sector by examination of soil moisture and pH value of the soil. In other cases, like vineyards, the diameter of the drunk can be monitored, and the vitamins present in specific quantities in agricultural products can be controlled by utilization of IoT. Not only this but the regulation

of microclimatic conditions for increasing the quality and productivity can be obtained for both vegetables and fruits. Additionally, the weather conditions can be forecasted, and multiple factors like humidity levels, temperature, and variation of wind speed and direction can be monitored, which helps prevent fungus or other contaminants. Another application is found in cattle farming by identifying animals grazing in open locations (Veena, S. et al., 2018).

Healthcare sector

The healthcare sector has noted numerous inefficiencies and mistakes in everyday operations. Therefore, errors can be avoided by using improved, upgraded, and automated-based technologies. In addition to that, multiple technologies such as sensing the situation of heart patient, identification of objects and maintenance of records of infants can be carried out by utilization of telemedicine solutions and other types of sensors. Moreover, progress can be observed in developments in materials and physical devices leading, from Internet of Things to Internet of Nano things and Internet of Everything. An illustration of Internet of Nano-things has been provided in figure 3, from which it can be observed that by just a chip having a sensing system and communication system, big data collection can be obtained for the patient, which can be beneficial in diagnostics (Miraz, M. et al., 2018).

The following section discusses the applications of Internet of Things in supply chain management, which is the chapter's primary focus. Therefore, the main aspects of IoT are going to be observed while finding the applications of technology being incorporated to support the whole supply chain system

Methodology

The logistics section, along with supply chain management, has been witnessing a tremendous paradigm shift. The increment of attention in supply chain management and logistics has motivated the researchers to focus on the strategies and critical operations of the companies to deal with the dynamic environment of the business. The organizations have continuously focused on delivering the right product and services to the right customer by upgrading the logistics and supply Management systems. For this purpose, the focus has been diverted toward developing novel methods, implementing new technologies, and achieving competitive advantages. The benefit of information exchange and facilitation to monitor physical goods has been observed throughout the whole supply chain procedure (Ben-Daya, M. et al., 2019).



Figure 3 Main dimensions of IoT in Supply Chain Management (Aryal, A. et al., 2018)

Information technology has been evolving and playing a vital role in improving planning, regulating, and implementing processes. It can be observed by the emerging concept of industry 4.0, which is proving to be the critical success factor in driving business with the inclusion of value chain activities and optimization of operations associated with the business.

With the smartness of supply chain systems, the surge of research in innovative addressable applications in the logistics and supply chain management sector has been observed, including IoT. Many definitions of IoT have been formed, and it can be observed in the literature, but the main focus is to involve smart devices and software to sense, control, monitor, interact and share the information of a product within a company or among the companies it's been list enabled the agility of the supply chain. Hence, the main aspect of things-oriented systems, Internet-oriented systems and semantic-oriented systems involving devices, sensors, knowledge, and middleware can be made accessible and applicable. Moreover, the capability of big data analytics can be increased, which not only improves the competitive advantage but also contribute to supply chain agility (Dubey, R. et al., 2019)

Despite the contribution of IoT in different sectors, as mentioned above, the main application has been founded in business that faces security and privacy issues, as shown in figure 4

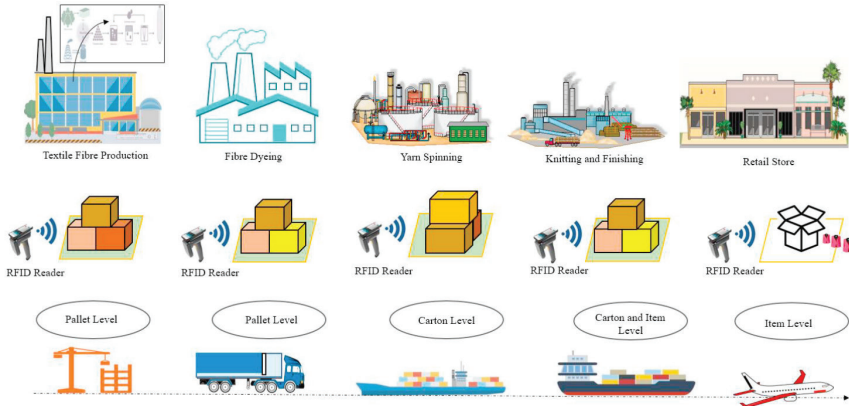

Figure 4 Role of RFID as an application of IoT in supply chain management (Pal, K. and Yasar. A., 2020)

Modern radio frequency identifiers (RFIDs) are available in the form of readers and tags, which involve information and communication mediums. The RFID tags involve sensing technology and incorporate data communication to improve the concept of IoT technology. The devices are connected with components in the raw form from production and delivery to the retail store, as shown in figure 4, and control the products being transported from one level to another. It requires service-oriented computing, IT-based information system, and blockchain technology (Pal, K. and Yasar. A., 2020).

According to (He, L. et al., 2020), it is mandatory to involve IoT in supply chain systems by considering the fact that the products shall be partly connected and be data-driven. This wires data collection which gets structured before passing to the view of detainees, stops once the data analysis is being carried out, the modeling, simulation, and forecasting steps must be performed to make supportive decisions. Therefore, the supply chain manufacturer must get information from suppliers and OEMs for the supply. After processing the information, the product shall be transferred to the retailer. All those activities must involve the utilization of information and resources or capacities provided by intelligently connected products through software, hardware, and production facilities interconnecting the information system and equipment.

Adaption of IoT in Supply Chain Management

The supply chain management is subdivided into many sectors that deal with various things and goods that are utilized in daily activities, such as surveillance, electronics, clothing, footwear, household goods, cosmetics, and pet products. The research work being carried out by (Vass, D. et

al., 2021) illustrated that medium and large firms have been implementing supply chains at different levels. The data on the adaption of the supply chain system by different sectors has been illustrated in Table 1. From the table, when it comes to supermarkets and departmental stores at large scale, the adoption of IoT in supply chain systems has been made by 10 years and 11 years. Whereas restaurants, cafes, and takeaway companies have adopted IoT at medium scales for over three years.

On the contrary, electronics and motor vehicle parts selling companies have been involving medium-scale IT managers to implement this technology for over 5 years. The utilization of IoT has been observed for the highest period of 15 years for clothing, personal accessories, and footwear companies at a large scale. This analysis has been provided in Table 1 as provided below.

Table 1 Adaption of IoT in different supply chain sectors (Vass, D. et al., 2021)

ID	Code	Work exp.	Job role	Retail sector	Key retail form	Firm size	First adapted IoT
1	A	2 yrs.	Supply manager chain	Cosmetic and toiletry	Omni-channel	Medium	Less than 2 years ago
2	B	11 yrs.	Supply manager chain	Department store	Bricks-and-mortar	Large	Over 11 years
3	C	3 yrs.	Supply manager chain	Supermarket	Bricks-and-mortar	Large	4 years ago
4	D	2 yrs.	Supply manager chain	Pet products	Omni-channel	Large	5 years at-least
5	E	3 yrs.	Owner	Restaurant/café/take-away	Omni-channel	Medium	3 years ago
6	F	4 yrs.	Supply manager chain	Telecommunication products / Electronics	Omni-channel	Large	3 years ago at least
7	G	5 yrs.	Supply manager chain	Clothing, footwear and personal accessories	Omni-channel	Large	Over 15 years
8	H	10 yrs.	IT manager	Motor vehicles parts and Electronics	Omni-channel	Medium	5 years at-least
9	I	5 yrs.	Supply manager chain	Supermarket	Bricks-and-mortar	Large	10 years at-least
10	J	20 yrs.	Store manager	Fuel and convenience stores	Bricks-and-mortar	Large	5 years ago
11	K	5 yrs.	IT manager	Security and surveillance/ Electronics	Omni-channel	Medium	5 years ago
12	L	7 yrs.	General manager	Household goods	E-tail	Medium	6 years ago

In order to adopt the IoT in the supply chain system, it is necessary to understand the challenges which have still hindered making progress and boosting the role of IoT in the supply chain system.

Challenges in adaption of IoT in Supply Chain Management

According to the researchers, the main obstacle to the adoption of Internet of Things in supply chain management is the cost. Many investors consider the cost to be the main parameter that prohibits the utilization of technology. In contrast, the large firms and investors of more prominent companies consider an investment as a liability rather than an improvement of business in the long term. Few investors consider the cost to be

an issue but also take into account the fact that this cost will be returned within operations of three to four years, depending upon the nature of the business and the investment that has been made in this technology (Vass, D. et al., 2021).

From Table 1, the observation carried out by the researcher illustrates that the supply chain manager of a departmental store in a supermarket argued that it is not a reasonable consideration that the manufacturer and suppliers at the upstream level bear the costs associated with technology such as RFID readers, tags and related software. The benefit is provided to the downstream partners. However, the supply chain manager of a supermarket store concluded that to increase business growth, both brand owners and retailers must invest (Vass, D. et al., 2021)

Similarly, another obstacle being observed by the supply chain managers is leadership issues which arise, especially when the role of technology is not plated at a significant level, and the managers do not pay attention to the technology. The supply chain manager of telecommunication products and electronics considers that the cost is not a big deal compared to the knowledge. The managers of different fields have considered that the vision to manage IoT allows the decision-makers to implement the technology and make beneficial decisions by utilization of the knowledge to use the technology (Vass, D. et al., 2021).

It was also observed that people resisted remaining on the old methods because they lacked the time for learning and adopting technology

Another issue that has been phased in implementing IoT in supply chain management is the hindrance internal and external stakeholders create in implementing the IoT. Many employees of the household goods sector consider that people shore leprosy to change their behavior. It was also observed that people resisted remaining on the old methods because they lacked the time for learning and adopting technology (Vass, D. et al., 2021).

Discussion and Conclusions

Supply chain management is a wholly technical department that integrates several disciplines into the production of a thing from conception to delivery, focusing on cost reduction at various points along the way. Even though much progress has been made in the supply chain system since the 1980s, such as frameworks and procedures, there is a huge lack of technological utilization, which results in the increment of the cost getting in the whole supply chain procedure. Therefore, IoT has to improve productivity, forecast demand, and supply, and ensure the product's safety passes from the raw form to the final product reaching the consumers'

doors. As a result, hardware and software programs have been developed to allow the investor to monitor the product as it is delivered to the consumer. It necessitates tracking devices, Internet connectivity, and hardware such as radio frequency identifiers to obtain information about the location and time when the product has arrived. The chapter proves valuable for small and medium-sized enterprises that do not invest in technology without knowing the benefit of business growth. From the results, it has been observed that many companies have been resisting implementing IoT without having sufficient knowledge that it involves the utilization of cloud technology, sensors, and RFID system to obtain the real-time status of the condition, location, and status of the product, which is in transportation fees. Additionally, visibility is increased by automation of the processes, including forecasting and management of orders and recommendations for the future. But with the provision of IoT-driven supply chain management systems, the end-to-end visibility is increased, the operational efficiency is increased at higher levels, the customer service is improved, inventory management is optimized, and waste management is dealt with efficiently in all the sectors of electronics food, oil, and gas, health and electronics.

References

- Aryal, A. et al. (2018). The emerging big data analytics and IoT in supply chain management: a systematic review. *Supply Chain Management: An International Journal*.
- Ben-Daya, M. et al. (2019). Internet of things and supply chain management: a literature review. *International Journal of Production Research* , 57(15-16).
- Dubey, R. et al. (2019). Big data analytics capability in supply chain agility: The moderating effect of organizational flexibility. *Management Decision*, 57(8), 2092-2112.
- Giordano-Spring, S. and Works, S. (2006). Integrated supply chain and integration of accounting information. *Logistics & Management*, 14(2), 3-13.
- He, L. et al. (2020). Internet-of-things enabled supply chain planning and coordination with big data services: Certain theoretic implications. *Journal of Management Science and Engineering*, 5, 1-22.
- Koot, M. et al. (2021). A systematic literature review of supply chain decision making supported by the Internet of Things and Big Data Analytics . *Computers & Industrial Engineering* , 154, 1-28.
- Kothari, S. et al. (2018). The Impact of IOT in Supply Chain Management. *International Research Journal of Engineering and Technology (IRJET)*, 5(8), 257-259.
- Legchekov, S. (2018). *Connected Suppl Chain | Internet of Things*. ScienceSoft.
- Miraz, M. et al. (2018). Internet of Nano-Things, Things and Everything: Future Growth Trends. *Future Internet*, 10(8).
- Pal, K. and Yasar. A. (2020). Manufacturing Supply Chain Data Management Manufacturing Supply Chain Data Management. *Procedia Computer Science*, 170, 450-457.
- SAP. (2020). *What is supply chain management (SCM) and why is it important?* Retrieved November 26, 2022, from <https://www.sap.com/insights/what-is-supply-chain-management-scm.html>
- Sfar, A. et al. (2017). A systemic and cognitive vision for IoT security: A case study of military live simulation and security challenges. *2017 International Conference on Smart, Monitored and Controlled Cities (SM2C)*. IEEE: Sfax, Tunisia.
- Sun, W. et al. (2022). Internet of things enabled the control and optimization of supply chain cost for unmanned convenience stores. *Alexandria Engineering Journal*, 61, 9149-9159.
- Vass, D. et al. (2021, 2021). IoT in Supply Chain Management: Opportunities and Challenges for Businesses in Early Industry 4.0 Context. *OPERATIONS AND SUPPLY CHAIN MANAGEMENT*, 2(2), 148-161.
- Veena, S. et al. (2018). Survey on Smart Agriculture Using IoT. *International*

Journal of Innovative Research in Engineering & Management, 5(2), 63-66.

Zanjal, S. and Talmale, G. (2016). Medicine Reminder and Monitoring System for Secure Health Using IOT. *Procedia Computer Science*, 78, 471-176.

Zhang, Y. and Zheng, W. (2019). Optimal RFID Deployment in a Multiple-Stage Production System Under Inventory Inaccuracy and Robust Control Policy. *IEEE Transactions on Industrial Informatics*, 15(6), 3230-3242.

“

Chapter 16

**APPLICATION OF THE ELMERI SAFETY
INDEX METHOD TO SOME CONSTRUCTIONS
IN THE ÇORUM REGION TO IMPROVE THE
RESPONSIBILITIES OF BUILDING CONTROL
FIRMS IN TERMS OF OCCUPATIONAL HEALTH
AND SAFETY**

Glden ASAN¹, Deniz ERDAL²

”

1 Hitit University, Vocational School of Technical Sciences, guldenasan@hitit.edu.tr , Çorum, Türkiye ORCID: 0000-0002-6075-159X

2 Hitit University, Graduate School of Education, Department of Occupational Health and Safety, denizerdal89@gmail.com , Çorum, Türkiye ORCID: 0000-0001-8826-0234

1. INTRODUCTION

The first written texts on occupational health and safety are known to have been written by Paracelsus in the 15th century. At the beginning of the 18th century, Bernardino Ramazzini wrote the book “*De Morbis Artificum Diatriba*” on occupational disease. Ramazzini is considered to be the ancestor of occupational health and occupational medicine. Ramazzini has written about the risks that threaten health in many professions, from tailors to trenchers (Frank, 2006). Until 2012, Turkey was carrying out its work on OHS with the provisions in the 5th part of the Labor Law and the relevant by-laws and regulations. When the Occupational Health and Safety Law No. 6331 was adopted in 2012, important steps were taken for our country in this regard and this situation was the subject of the 2012 European Union Progress Report (Korkut and Tetik, 2013). Thus, a new era regarding Occupational Health and Safety has started for Turkey (Korkmaz and Avsallı, 2012).

According to the estimates of the ILO, every 15 seconds a worker dies from an occupational disease or work accident in the world. Again, every 15 seconds, 160 workers have an accident due to work-related reasons. Work-related diseases and occupational accidents cause 6300 deaths every day, and 2.3 million employees lose their lives in terms of years. From the perspective of absenteeism, more than 337 million people are absent from work annually as a result of work accidents. When the result is examined from a material point of view, it is known that the cost due to insufficient OHS practices is approximately 4% of the annual gross domestic product (Kılıkış and Demir, 2012). According to SGK 2020 data in Turkey, approximately 4 people die a day due to work accidents and occupational diseases. However, it is known that 9 people were disabled in one day due to the same reasons. For these reasons, our country has many problems such as loss of workforce, health payments such as medicines and doctors, compensation expenses, payments due to temporary and permanent incapacity for work, damage to the tools used, loss of motivation in the working environment due to accidents, and loss of productivity due to this reason. Negative factors make up 4% of our national income and this is a really big ratio. In addition to this, moral damages are seen as a result of work accidents and occupational diseases, it causes widows and orphans, and many spiritual difficulties may occur, such as worrying about the future of these children (Korkut and Tetik, 2013). In a construction audit of the organizations that carry out building inspection activities in the construction sector, the compliance of the on-site production with the required plans and projects is inspected by adhering to a project or report in the formwork, iron or wall controls. Likewise, in terms of occupational health and safety, if they have a material that they can adhere to in terms of fulfilling their duties,

deficiencies in terms of occupational health and safety can be inspected in a healthy and safe way as it should be. At this stage, an audit sheet on occupational health and safety can be added to all projects with the necessary legislative work to be done by the state. Thus, a standard can be created without the need to prepare separate occupational health and safety checklist lists for each construction. Classifying the checklists according to the nature of the work while creating the standard will facilitate the audit.

2. PREPARATION OF CHECKLIST FORMS

In the study, we suggest performing the necessary inspection task with a checklist form as in Table 1 to be used in the inspections to be made on behalf of occupational health and safety. While preparing the checklist forms given below, the Occupational Health and Law No. 6331, the related articles of the Occupational Health and Safety Regulation in Construction Works, the related articles of the Regulation on Health and Safety Conditions in the Use of Work Equipment and the experiences of Deniz Erdal, a civil engineer working as a control staff in a building inspection company. prepared using it.

Table 1. Checklist prepared for the inspection of the construction in terms of occupational health and safety

..... Island ParcelYıbf Occupational Health and Safety Measures Checklist for Construction		
OCCUPATIONAL SAFETY MEASURE	YES	NO
Do employees use general personal protective equipment?		
Are dangerous gaps and pits delimited by guardrails? Are these places noticed by the employees by using warning signs or boards such as signboards?		
If employees work at a height exceeding 3 meters, are they provided to wear seat belts?		
If there is a scaffold; Is it made of durable material suitable for the scaffolding project?		
Are the places where the power line passes in the construction site determined and are the workers paid attention with a warning sign?		
Is the presence of electrical transmission cables, plumbing pipes, sewer channels and natural gas pipelines in the area to be excavated checked before the excavation and necessary precautions are taken, if any?		
Is it ensured that the personnel dealing with electrical work wear rubber boots and gloves made of plastic material in order to prevent electric shock?		
Is it ensured that the signs and plates prepared in accordance with the Health and Safety Signs Regulation are in places where everyone can see them?		
Are the materials ensured to be stacked within the rules in a way that does not pose a hazard?		

Is a skirt board made to the edge of the floor in order to prevent the material used in the construction from falling down from the load piers?		
If work is carried out with a purse-seine crane; Has a precaution been taken to ensure that it is not so close as to threaten security?		
Are there first aid cabinets containing first aid materials in a suitable place within the construction site?		
Hazardous sections within the construction site are clearly demarcated to attract the attention of employees, and are appropriately written warning signs and signs placed so that these sections can be seen easily?		
Are railings made in appropriate sizes to prevent falling on the floor edges of reinforced concrete platforms?		
Is the edge of the deck on each floor of the construction wrapped with a warning tape in red-white color?		
Are guardrails made to prevent falling over the edge of the stairwell?		
Are elevator shafts covered with a solid material to ensure safety with horizontal and vertical diagonals?		
Are measures taken to prevent collapse such as shoring, curtain or digging with slopes in deep excavations?		
Is there a platform made of insulating material (mat made of plastic material or wooden grating) at the bases of the electrical panels in the construction site?		

As stated in the table above, questions on general manufacturing can be reproduced, and these checklists can also be prepared separately according to the field of manufacture or line of business. For example, a separate checklist can be prepared for the precautions to be taken during excavation, a separate checklist for the OHS measures to be taken during the concrete casting production, or a separate checklist for the electricity used in the construction or manufactured.

With these checklists, the building inspection personnel who will come to the construction site will be able to conduct a more effective inspection on behalf of occupational health and safety. Thus, it will be ensured that there are no overlooked points, and a safer and healthier inspection of the manufacturing or structure in terms of occupational health and safety will be ensured.

After making the inspections of the building inspection staff with ready-made checklist forms, the necessary deficiencies should be reported to the contractor in the form of a report or a report. If the necessary measures are not taken in the time given according to the nature of the work, it will have done its duty in the name of occupational health and safety by notifying the relevant administration. Thus, the responsibility in this matter will be eliminated and a safer work environment will be provided.

3. CHECKLISTS THAT CAN BE USED IN CONSTRUCTION WORKS

3.1. Checklist for Excavation Works

Excavation works are one of the phases in which occupational accidents are frequently seen in building construction. Occupational accidents that occur during the excavation works can result in injury, disability and even death. In order to prevent or minimize the amount of work accidents that may occur during the excavation works, a planning should be made before starting the excavation work. In this planning, measures should be taken against these risks by considering the risk situations that may occur during the work (BYU, Excavation Program, 2006). For the stated reasons, the checklist, which includes the principles to be followed regarding occupational health and safety during the excavation works, is given in Table 2, taking into account the relevant standards.

Table 2. *The list prepared for the examination of the construction in terms of occupational health and safety in excavation works*

..... Island ParcelOccupational Health and Safety Measures Checklist in Excavation Works of Construction No. Yibf			
Owner's Name:			
Contractor:			
Checker Name:			
Duty of Controller:			
Weather forecast:			
History:			
Signature:			
NUMBER	OCCUPATIONAL SAFETY MEASURE	YES	NO
1	Do the workers working in excavation works have the necessary information about OHS?		
2	Do the workers working in excavation works use personal protective equipment related to OHS?		
3	Is the area around the excavated area covered with a 2 meter high wooden or other material curtain, and these curtains are supported with a buttress behind them?		
4	Is there a wide enough road for vehicles and vehicles entering and exiting the excavated area?		
5	Has enough slope been given under the control of the relevant technical personnel, depending on the depth of the excavation and the soil type?		
6	Is there adequate lighting when excavation work is done at night?		
7	If there are structures close to the excavated area or adjacent structures, is there a necessary support system to prevent them from being affected by the excavation?		
8	Are the materials extracted from the excavation site transported to the appropriate places?		

9	Was information received from relevant institutions and organizations regarding the locations of possible infrastructure networks in the excavation area during the excavation works?		
10	Is there any work other than the construction equipment in the field where the excavation work is carried out?		

3.2. Checklist for Mold Manufacturing and Mold Removal Works

One of the stages where work accidents are quite high in construction works is the assembly and disassembly of formwork. In order to prevent work accidents that may occur in mold works, first of all, necessary warnings and information about occupational health and safety should be given to mold workers. The checklist in Table 3 has been prepared, considering that it will help minimize work accidents that may occur during mold assembly and dismantling related to mold works.

Table 3. The list prepared for the examination of the construction in terms of occupational health and safety in formwork manufacturing and dismantling works

..... Island ParcelOccupational Health and Safety Measures Checklist in Mold Manufacturing and Dismantling Works of Construction No. Yibf			
Owner's Name:			
Contractor:			
Checker Name:			
Duty of Controller:			
Weather forecast:			
History:			
Signature:			
NUMBER	OCCUPATIONAL SAFETY MEASURE	YES	NO
1	Do the workers working in mold works have the necessary information about OHS?		
2	Do the workers working in mold works use personal protective equipment related to OHS?		
3	Do the workers working in the mold business have a professional qualification certificate?		
4	Are the materials used in mold manufacturing stacked in a way that does not require long-term transportation within the construction?		
5	Are hand ladders used in formwork solid and used at appropriate slopes? (Slope ¼)		
6	Is an appropriate division of labor made so that workers do not harm each other during mold manufacturing and mold material handling?		
7	Are railings made with suitable strength on the outer surfaces of the floor molds?		

8	During the dismantling of the slab formwork, is the entrance to this area under control, except for the dismantling workers?		
9	After the demoulding work is completed, are the nails around and the materials stacked regularly?		
10	After the dismantling work is completed, are adequately strong handrails made in front of the elevator?		
11	After the demoulding work is completed, are the shaft and ventilation gaps closed with suitable material with a railing on the sides of the building stairs?		
12	Do all of the workers working in mold works have a health report stating “There is no obstacle in working in heavy and dangerous works”?		
13	Are there warning and warning signs related to the personal protective equipment required to be used by the workers who manufacture molds in suitable places within the construction?		
14	Has the elevator equipment used for lowering or raising the material used in mold manufacturing been checked?		

3.3. Iron Works Checklist

It is one of the construction works where the risk of occupational accident is quite high in works such as lifting, transporting, processing and assembling the reinforced concrete iron used in construction. In order to minimize the occurrence of work accidents during iron works, it is necessary to take measures against possible dangerous situations. Considering the risks in reinforced concrete iron works, the checklist in Table 4 has been prepared in order to reduce occupational accidents during this work process.

Table 4. *The list prepared for the examination of the construction in terms of occupational health and safety in iron works*

..... Island ParcelOccupational Health and Safety Measures Checklist in Iron Works of Construction No. Yibf			
Owner's Name:			
Contractor:			
Checker Name:			
Duty of Controller:			
Weather forecast:			
History:			
Signature:			
NUMBER	OCCUPATIONAL SAFETY MEASURE	YES	NO
1	Do the workers working in iron works have the necessary information about OHS?		
2	Do workers in iron works use personal protective equipment related to OHS?		
3	Do the workers working in the iron business have a professional qualification certificate?		
4	Do ironworkers have a tetanus vaccine?		
5	Is the location of the iron to be lowered to the construction site chosen in a way that does not allow unnecessary transportation?		
6	Are the tools used by the workers in iron work in cutting and bending of iron and the tools used to carry the iron up, are the maintenance done regularly?		
7	Do all ironworkers have a health report stating "there is no obstacle to working in heavy and dangerous jobs"?		
8	Are there warning and warning signs related to the personal protective equipment required to be used by workers working in ironworks at suitable places within the construction?		
9	Were the pieces of iron that came out as a result of cutting the irons collected and stacked regularly?		
10	If electric iron benches are used during iron cutting and bending; grounding, foot pedal cover, emergency stop button?		

3.4. Checklist for Concrete Works

Concrete production and pouring is one of the phases in which occupational accidents occur frequently in constructions. In particular, the pouring of concrete should be carried out under the control of the responsible technical staff at the construction site from the beginning to the end of the pouring process. Before starting the concrete pouring work, the possible situations that may cause work accidents during the pouring of the concrete should be evaluated and necessary precautions should be taken. Considering the risks associated with pouring concrete in constructions, the checklist in Table 5 has been created.

Table 5. *The list prepared for the examination of the construction in terms of occupational health and safety in concrete works*

..... Island ParcelOccupational Health and Safety Measures Checklist in Concrete Works of Construction No. Yibf			
Owner's Name:			
Contractor:			
Checker Name:			
Duty of Controller:			
Weather forecast:			
History:			
Signature:			
NUMBER	OCCUPATIONAL SAFETY MEASURE	YES	NO
1	Do workers working in concrete works have the necessary information about OHS?		
2	Do workers working in concrete works use personal protective equipment related to OHS?		
3	Do the workers working in the concrete business have a professional qualification certificate?		
4	Has a place been determined for the concrete pump on the construction site in such a way that it will not interfere with other works and will not pose a danger?		
5	Do concrete truck mixers enter and exit the construction site negatively affect other workers?		
6	Is there a communication system between the operator using the concrete pump and the personnel using the concrete truck mixer to stop the concrete work in an emergency?		
7	Have the vibrators used during concrete pouring been checked for electrical leakage?		
8	Is there sufficient lighting to illuminate the construction in case the concrete casting works are carried out at night?		
9	Were the molds and supports checked by the relevant technical personnel before concrete casting?		
10	While pouring the slab concrete, is the casting done within the framework of a certain plan so that the load is evenly distributed?		
11	While pouring the concrete of high columns and walls, is it poured at intervals in the form of two or three times?		
12	Do all the workers working in concrete works have a health report stating "There is no obstacle in working in heavy and dangerous works"?		
13	Are there warning and warning signs related to the personal protective equipment required to be used by workers who do concrete works in suitable places within the construction?		

3.5. Checklist for Wall Works

At the stage of wall production in construction; Some occupational diseases can be seen during the preparation of masonry mortar and material transportation, and work accidents are common, since masonry work must be done at a certain height from the ground. In order to prevent occupational disease and work accident during the manufacture of the wall, situations that threaten worker health and pose a risk in terms of safety should be determined as early as possible and the necessary occupational health and safety measures should be taken to eliminate the aforementioned dangers. The checklist prepared in order to reduce the possibility of occupational accidents during this work process, taking into account the risks that may pose a danger in relation to the manufacture of the wall during the construction of the building, is given in Table 6.

Table 6. *The list prepared for the examination of the construction in terms of occupational health and safety in Wall Works*

..... Island ParcelOccupational Health and Safety Measures Checklist in Wall Works of Construction No. Yıbf			
Owner's Name:			
Contractor:			
Checker Name:			
Duty of Controller:			
Weather forecast:			
History:			
Signature:			
NUMBER	OCCUPATIONAL SAFETY MEASURE	YES	NO
1	Do the workers working in wall works have the necessary information about OHS?		
2	Do workers in wall works use personal protective equipment related to OHS?		
3	Do the workers working in masonry have a professional qualification certificate?		
4	Are wall materials such as bricks, mortar and cement coming to the construction site stacked in a way that prevents unnecessary transportation?		
5	Is the maintenance of vehicles such as elevators used to carry wall materials to the upper floors routinely checked?		
6	Is the robustness of wheelbarrows used for transporting bricks, cement and mortar checked?		
7	Have necessary precautions been taken to prevent material from falling down during the construction of the outer walls of the building?		
8	Are the chimney shaft gaps closed and safety measures taken on the french window and open floor edges to prevent falling in the places where the wall production is completed?		

9	Do all of the workers working in masonry have a health report stating “There is no obstacle in working in heavy and dangerous works”?		
10	Are there warning and warning signs related to the personal protective equipment that should be used by workers who do masonry work in suitable places within the construction?		

3.6. Checklist for Establishing Scaffolding and Working on Scaffolding

During the construction of the scaffolding and during the work on the scaffold, many work accidents can occur in construction. The aforementioned work accidents can be caused by the carelessness of the workers, the mistakes made during the erection of the scaffold, and the insufficient strength of the material used in the erection of the scaffold. In order to prevent the workers working on the scaffolding from being exposed to occupational accidents, the risks that may create a dangerous situation in terms of occupational health and safety should be evaluated, starting from the stage of scaffolding, and precautions should be taken against the aforementioned risks. Considering the risks that may arise from the scaffold during the construction of the structure, the checklist in Table 7 has been prepared in order to reduce the occurrence of occupational accidents during this working process.

Table 7. *The list prepared for the examination of scaffolding in construction and work on the scaffold in terms of occupational health and safety*

..... Island Parcel Occupational Health and Safety Measures Checklist for Establishment of Scaffolding and Work on the Pier belonging to the Construction No. Yibf			
Owner's Name:			
Contractor:			
Checker Name:			
Duty of Controller:			
Weather forecast:			
History:			
Signature:			
NUMBER	OCCUPATIONAL SAFETY MEASURE	YES	NO
1	Do the workers working in scaffolding works have the necessary information about OHS?		
2	Do workers at scaffolding use personal protective equipment related to OHS?		
3	Do the workers working in scaffolding have a professional qualification certificate?		
4	Is the scaffolding made in accordance with the scaffolding project?		

5	Are the cross-sections of the materials used in the scaffolding appropriate in terms of carrying capacity and is the scaffolding material of sufficient strength?		
6	Is the number of connections between the scaffold and the construction made in sufficient quantity and in a solid manner?		
7	Are there any wastes that will prevent work on the platforms and passages used at the pier?		
8	Have precautions been taken to prevent slipperiness that may occur on the pier due to climatic conditions?		
9	Are the mechanical parts of suspended scaffolds checked and reported before starting daily work?		
10	Is there sufficient lighting in case of night work at the pier?		
11	Is the maximum load that the scaffold can carry indicated by warning signs?		
12	During the dismantling of the upper floors of the scaffolding, is it observed that no workers are employed on the lower floors?		
13	Do all of the workers working in scaffolding have a health report with the phrase “there is no obstacle to working in heavy and dangerous works”?		
14	Are there warning and warning signs related to the personal protective equipment required to be used by workers who do scaffolding works in suitable places within the construction?		

The number of checklists recommended for different manufacturing branches in construction works and the number of questions in these checklists can be further increased. The checklist questions we have prepared have been prepared using our own experience and the relevant laws and regulations. If these forms are created by the state, a standard in this regard will be provided and safer construction work environments will be created.

4. APPLICATION OF ELMERİ^{construction} METHOD TO SOME CONSTRUCTIONS

In this title, it is explained step by step how the observation studies are carried out using the ELMERİ® method regarding the OHS issues of randomly selected constructions within the borders of Çorum. Observations were made at ten different construction sites. Occupational health and safety issues were observed and marked as true or false in the relevant sections of the ELMERİ^{construction} form. Subjects that could not be observed at the time of observation were stated as no observations. As a result of the visits, occupational safety index was calculated out of one hundred for each construction. Observation studies carried out in the constructions

were examined under nine headings. These;

1. Occupational health and safety behavior and training,
2. Order, organization and cleanliness,
3. Machinery safety,
4. Physical, chemical and biological factors,
5. Ergonomics,
6. Ground, passageways and access conditions,
7. Electricity, fire and first aid,
8. Piers,
9. Construction Site.

4.1. OHS Behavior and Training

The behavior is marked as “correct” if the workers use the necessary personal protective equipment at the construction site and do not take any possible risks. Personal protective equipment and equipment that can be used in the construction environment can be listed as follows:

- Helmets
- Steel-toed shoes
- Protective mask and goggles - earplugs
- Warning vest
- Gloves
- Safety belts against falling for those working at height

The issues that will be considered as risky work can be listed as follows:

- Improper use of tools and equipment
- Disabling or disabling safety equipment
- Repairing machinery and equipment in working order

While making the evaluation, the data observed in the construction were taken as basis.

While making the evaluation, the “wrong” situation was evaluated as wrong regardless of what the reason was. For example, even if the construction worker uses steel-toed shoes as personal protective equipment, wears a construction vest, but does not wear a hard hat, this practice is considered “wrong”.

While evaluating the constructions under this heading, if there is a construction personal protective equipment for the PPE status, one observation was made, if not correct, then 1 observation was made. For the use of PPE and the risk status, it was considered as the PPE usage status of the workers at the time of observation and observations were made as much as the number of workers. During the observation for professional qualification, the number of workers who were asked whether the workers working in the construction had a professional qualification certificate or not, were observed. For the OHS training, the workers during the observation were asked whether they had OHS training or not, and observations were made as much as the number of workers, and the ones that were not “correct” were marked on the ELMERI^{construction} observation form as “false”.

4.2. Order and Cleanliness

Regarding the order and cleanliness section, the following situations are considered “correct”.

- The materials stacked in the construction are stacked properly so that they will not hinder other workers and other works.
- Construction wastes are removed from the construction site not randomly, but within the framework of a certain order, without damaging the environment.
- There are no nails, mold wastes and iron wastes on the floors and platforms. After the mold, wall and iron fabrications, the floors were cleared of construction waste.

While evaluating this title in constructions, 1 observation was made for material stacking, as “correct” if the material stacking in the construction is appropriate, and “false” if not appropriate. For construction waste management, if the construction wastes are disposed of regularly and in a way that does not affect anyone negatively, 1 observation was made as “false” if not “correct”. For the construction floor floors and passageways, observations were made as much as the number of floors whose concrete production was completed in the construction.

4.3. Machine Status

Observations were made for each machine and equipment in the construction area. If there is no machinery or equipment at the construction site during the evaluation, it is marked as “no observations made”. Regarding the conditions of machinery and equipment, the evaluation was made as “correct” in the following situations.

- Machine setup is stable and solid.
- The moving parts of the machines have been properly preserved.

- Complies with safety standards.
- It is where it should be and undamaged.
- Not in a non-functional state
- There are appropriate and visible warning notices.
- The emergency stop button is clearly visible and easily accessible from the working place.

While evaluating the constructions under this title, observations were made as much as the number of machines used in the construction during the observation.

4.4. Physical, Chemical and Biological Factors

In each construction, observations related to industrial cleaning were made. In the evaluations made at the construction site, the following cases were evaluated as “correct”.

- Normal conversations should be able to be heard from 1 meter away; this situation

data shows that the noise level is below 85 dB(A).

- Workers working in a noisy environment (killing with hilti, etc.) have personal protective equipment such as earplugs.

- Illumination level is sufficient.

- There is continuous working lighting in the passageways of the construction area.

- There are no air pollutants originating from smoke, gas, steam or living organisms in the evaluated area. In such cases, employees use the necessary personal protective equipment.

While evaluating under this heading in constructions, 1 observation was made for each item, if not “correct” or “false”, if the above-mentioned conditions for sound condition, lighting adequacy, ambient air and temperature and chemical substances are met.

4.5. Ergonomics

While evaluating the ergonomics, the following situations were taken into consideration:

- Heavy loads are not lifted, pushed or pulled by workers using physical force.

- Working area is sufficient for workers in the construction. Tools, equipment and work materials are appropriate and sufficient.

- Correct body position is taken in exercises that require physical strength.

While evaluating under this heading in constructions, observations were made as much as the number of workers working on the skeletal system during the observation for studies related to the skeletal system. In addition, observations were made for the employee position and the working area as much as the number of different working areas of the workers.

4.6. Ground, Passways and Access Conditions

All floors have been evaluated separately in relation to the condition of the ground and passageways within the construction. In these assessments, the risks that may pose a security threat related to continuously used places, stairs, elevators, slab edges, shaft gaps, French windows have been taken into consideration. A “correct” score is awarded when:

- The floor and work area are in good condition, level and fall-proof and non-slippery.
- There are walkways and access roads of sufficient width and height.
- Railings are made of suitable material and required dimensions for the edges of the stairs.
- The elevator fronts are covered with a suitable and visible material to prevent falling.
- After the demoulding process, until the wall production, the slab edges were surrounded with suitable material and safety measures were taken.
- The chimney, shaft and ventilation gaps are covered with suitable and durable material to prevent falling.
- After the exterior wall fabrication, the French window openings are properly closed.

While evaluating under this heading in constructions, observations were made for stairs and elevators as much as the number of floors whose concrete production was completed. For the windows item, observations were made as much as the number of floors for which the wall production was completed. For the shaft and ventilation gaps and flooring materials, observations were made for the number of floors where the concrete production was completed and the wall construction has not started yet, and those who meet the above conditions are marked as “correct” and those that do not meet the requirements as “false”.

4.7. Electricity, Fire and First Aid

Observations were made under five different headings in the field of first aid and fire safety. The following cases are marked as “correct”:

- Measures were taken against leakage current in the electrical panel used in construction works, the sockets were covered and 0.8 m of free space was left in front of the panel.

- The electrical panel used in construction works is located in a locked cabinet and cell to prevent unauthorized use and to be protected from external influences.

- The mobile electrical cables used in the construction site have been drawn in such a way as to be protected from external effects.

- Electrical installation and electrical equipment are in order and in good condition.

- All necessary first aid supplies are available.

- Fire extinguishers are available, easy to access and use, and inspected.

- There are emergency exits, there are no obstacles in front of the exit. In case of power failure, the signs are visible. Practice should be done at least once a year.

While evaluating under this heading in constructions, one observation was made by marking “correct” if it was found for the first aid cabinet and fire extinguishing agents, and “false” if it was not found. If they meet the necessary conditions for the electrical panel and emergency exits, one observation was made as “correct”, otherwise “false”. For electrical devices, observations were made as much as the number of electrical devices used in the construction during the observation.

4.8. Piers

In this section, if there are facade scaffolding or scaffolding used for fine workmanship during the observation in the construction, observations were made for them. It is rated as “correct” if:

- The scaffolding used for the facade was manufactured in accordance with the project and safely.

- All parts of the facade scaffolding system are solid, have not suffered from any corrosion or loss of cross-section against impact, and are checked at appropriate intervals.

- There is a grounding device on the facade scaffolding.

- The anchor scaffolds used in the construction are made of durable material.

While evaluating under this heading in constructions, if there is a facade scaffolding for the facade scaffolds and if it meets the conditions mentioned above, it is “correct”, if it does not carry it, 1 observation is made, as “false”.

For the item of scaffolds used in the construction, observations were made as much as the number of scaffolding (scaffolding) used in the construction, excluding the facade scaffolding, and relevant markings were made.

4.9. Construction Site

In the construction site section, evaluations were made under three separate headings. The following conditions are considered “correct”.

- There are warning and warning signs inside and outside the construction so that workers can see and read easily.
- At the construction site, the materials are properly stacked so as not to disturb the people and vehicles working inside the construction and outside the construction.
- The area around the construction is properly covered with suitable material to prevent unauthorized persons from entering.

While evaluating the constructions under this title, 2 observations were made for the safety and warning signs, by evaluating them separately inside and outside the construction. For the material stacking material, the condition of the materials other than construction was evaluated and 1 observation was made, as “correct” if they meet the conditions stated above, and “false” otherwise. Again, for the construction environment item, if the construction environment was closed at a suitable height with appropriate material, if no “correct” security measures were taken or if it was incorrect or incomplete, 1 observation was made by marking it as “false”.

5. FINDINGS AND DISCUSSION

In this study, observations were made using the ELMERI^{construction} method related to occupational health and safety in randomly selected constructions in the center of Çorum and inspected by building inspection companies. Observations were made at 10 construction sites at different levels. During these observations, issues related to occupational health and safety were evaluated and the relevant sections of the ELMERI^{construction} observation form were marked as true or false. As a result of the observations, the correct and incorrect numbers were added separately, and the correct sum was divided by the correct and incorrect sum, and the Elmeri safety index was calculated out of one hundred. Those who want to examine the ELMERI^{construction} observation forms of constructions in detail can see them in Deniz Erdal’s master’s thesis (Erdal D., 2022). ELMERI^{construction} safety indices for 10 constructions are calculated from all these obtained data and given as a graph in Figure 1. The highest ELMERI^{construction} safety index was obtained in construction-9 with 75%, and the lowest ELMERI^{construction} safety index was obtained in construction-3 with 38%.

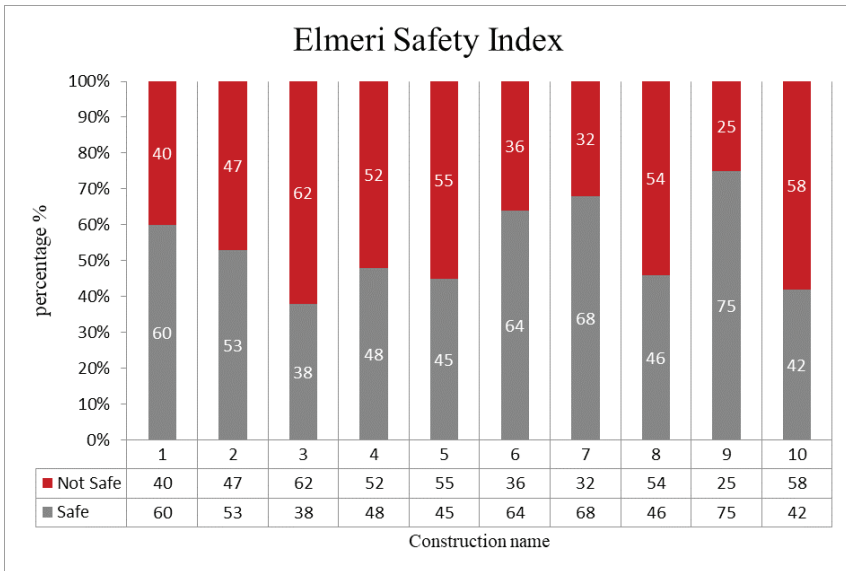

Figure 1. $ELMERI^{construction}$ Safety Indexes of the Constructions observed within the scope of this study

$ELMERI^{construction}$ safety indexes according to their subjects are given in Table 8. The lowest $ELMERI^{construction}$ is scaffolding with 13%. According to the research report of the Labor Inspection Board of the Ministry of Labor and Social Security, in these accidents, in which one of every two fatal work accidents is caused by falling from a height, falling from the floor, falling from the scaffolding, unclassified falls, falling during the mold manufacturing process, falling from the roof, falling from the elevator, stairs and floor space are in the first place. (Ministry of Labor and Social Security, 2016). Considering the $ELMERI^{construction}$ safety index according to their subjects, the issue of scaffolds supports the aforementioned statistics and the scaffolds used in construction contain a high risk in terms of occupational health and safety. In addition, the reason why the result was so low in the observations is that the anchor scaffolds used by the workers in the construction are not suitable in terms of occupational health and safety. In the construction observations, it was seen that the anchor scaffolds used were randomly manufactured from materials of uncertain durability. When we look at ergonomics and physical, chemical and biological factors, they have been the subjects with the highest value with the results of 100% and 97% $ELMERI^{construction}$ safety indexes. When we look at the reason why the subject of ergonomics has such a high safety index, the construction workers lift the loads that they cannot lift with the machine as much as possible, and they take the correct position of their bodies for the loads they need to lift. However, when we consider the general condi-

tion of the constructions, this high result can be misleading, because they realized that the workers were evaluated during the observation, they did not act dangerously that would put themselves at risk, they did not lift the loads that would adversely affect their skeletal system, and they took the correct body positions, especially when lifting loads that could be lifted by human power (for example, : bending by bending their knees, not at the waist) were observed. Therefore, the safety index has such a high value.

At the same time, when we look at the physical, chemical and biological factors, the general sound level in the construction is appropriate, the lighting is sufficient in the construction and night works, the air and temperature conditions in the construction are at a working level for the workers, which causes the safety index to be higher in this regard. The construction observations made during the summer months had a positive effect on the results, especially in terms of air and ambient temperature. Because if we consider the workers working in the construction environment during the winter months, cold weather conditions will not give the workers the opportunity to work in very suitable conditions in terms of occupational health and safety. Therefore, productivity and worker health, which are among the objectives of occupational health and safety, will be adversely affected. When we look at occupational health and safety behavior and training, it is seen that the safety index is 42%. Observations made in constructions show that none of the workers working in the observed constructions fully use personal protective equipment. The workers who use it either only use steel-toed shoes or wear vests. In other words, personal protective equipment is missing or not used at all. This is the main reason for the low safety index on this subject.

At the same time, when we look at Figure 2, one of the subjects with low ELMERI^{construction} safety index is first aid and fire safety, which is the 7th subject. The main reason for the low safety index on this subject is that when we look at the results of the observation forms, there is no fire extinguisher in any construction and there is no first aid materials in any construction except 1 construction. At the same time, there are no warning signs indicating emergency exits. The ELMERI^{construction} safety index of the construction site subject, which is the subject 9, has again a low value of 48%. According to the observations, most of the constructions do not have safety and warning signs, and some constructions are not closed to prevent unauthorized people from entering. These results cause the safety index to be low.

Table 8. ELMERI^{construction} safety index by subject

Topics	Number of Observations	Number of True	Elmeri Security Index(%)
1. OHS behavior, training	163	68	42
2. Order, organization and cleanliness	62	49	79
3. Machine status	32	28	88
4. Physical, chemical and biological factors	29	28	97
5. Ergonomics	30	30	100
6. Grounds, passageways and access conditions	176	84	48
7. Electricity, fire and first aid	51	21	41
8. Piers	24	3	13
9. Construction site	40	19	48

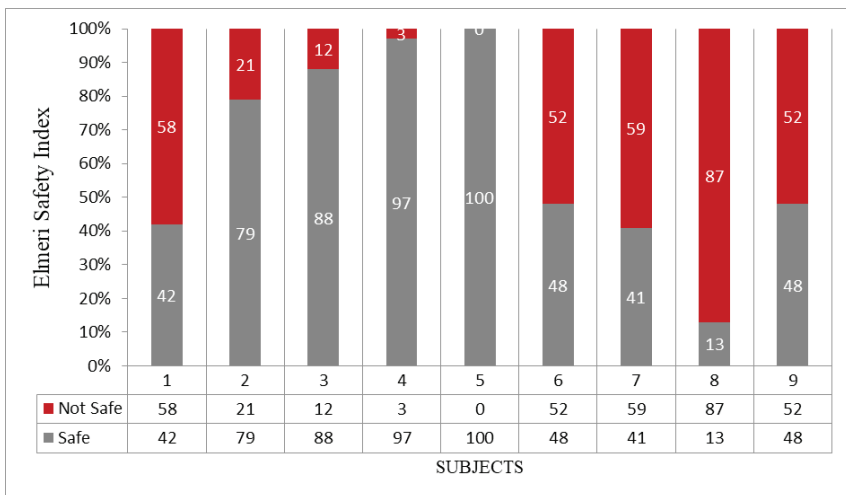
Figure 2. ELMERI^{construction} Safety Index of Constructions by Subject

Based on all these data, occupational health and safety measures are not fully taken in most of the constructions inspected by building inspection companies, and the contractor is also responsible for the emergence of this result, according to the results in the Elmeri observation form. For example, we mentioned that workers do not use PPE in any construction, but some constructions do not even have personal protective equipment that the contractor should have. This shows that most contractors do not attach importance to occupational health and safety. Therefore, if the nec-

essary warnings are not made to the contractor and the relevant institutions are not notified, it shows that the building inspection company also ignores the occupational health and safety, although it is one of its basic duties. As we have already mentioned in the above issues, if the building inspection company does not make warnings about occupational health and safety and does not inform the relevant administration, it means that it does not perform its duty related to occupational health and safety as specified in the law numbered 4708.

6. CONCLUSIONS AND RECOMMENDATIONS

Another important factor in making safe and healthy production in construction activities is to provide a safe work environment, which will be carried out jointly by all parties during the production phase. Regarding occupational health and safety, our state's laws, regulations, etc. Employers and workers have obligations to comply with standards such as these regulations and laws made by the state. In this sense, building inspection companies have also determined that the measures related to occupational health and safety should be at the construction site, in the light of the provisions of the Law No. They are responsible for checking whether In case of any violation, it is responsible for determining what they are and warning the contractor, who is the contractor, and then notifying the Directorate of Labor and Employment Agency, which is the relevant administration, for the measures that are not taken properly in response to all warnings.

Both building inspection and OHS activities are important services for the public. Occupational health and safety in construction works, as understood by the vast majority of contractors, warning signs, helmets and safety belts, etc. It will be possible not only to use personal protective equipment, but in a broader sense, to apply safe and healthy construction standards and methods effectively during the manufacturing phase. While the main task of the building inspection companies is to supervise the construction of the construction in accordance with the project, technical standards, science and art standards; The compliance inspection to be carried out on whether the occupational health and safety measures related to the construction works at the construction site are adequately applied on site constitutes a kind of secondary, sub- or secondary task. The audit firm shall discharge all administrative, legal and penal responsibilities that may arise by warning the building contractor, who is in charge of the implementation of occupational health and safety measures, about the violations and notifying the relevant administration of the violations that have not been made. At the same time, the number of work accidents that may occur will be reduced.

In our opinion, in order for the warning that the building inspection company will notify to the contractor to be more effective, it would be

more appropriate to give the construction inspection the chance to issue a construction holiday license, while notifying the administration of the violation that is not made or made incompletely, until the contradictions that need to be corrected are made within the framework of the law. Otherwise, if there is no work accident or occupational disease at the construction site, occupational health and safety measures that are not taken by considering the financial interests of the contractor can be implemented in the form of not making a warning or bypassing it with a verbal warning. Unfortunately, at this stage, the financial sanctions to be applied by the administration will not be enough to reach the desired result. Likewise, if it is determined through the auditing of the activities of the audit firms that they do not fulfill their duties related to occupational health and safety in the structures, the financial sanctions or administrative practices applied to the firms should be seriously deterrent. While this is the case, it is of great importance that the administratively responsible units have sufficient technical and qualified personnel to conduct on-site inspections. The fact that the duty of the building inspection firm to warn the contractor, which is deficient, related to occupational health and safety, is not bound to a rule on how to do it in the law, and it may be difficult to prove the warning made in legal disputes that may arise on the subject. Beyond the written warning letter in hand or the warning about the necessary deficiency in the construction site book, the notification made through the notary public through official means, besides being a means of proof, will help the building inspection company to pay more attention to the event for the building contractor.

The boss and staff of the building inspection firm should also have a safety culture as expected from the contractor and employee. The acquisition of safety culture should be assumed as an important aim of the trainings to be given at this stage (Kılıkış, İ., 2012).

As a result of the observations made with the Elmeri method, it is seen that occupational health and safety are ignored in the constructions inspected by the building inspection companies. Although it is one of the main duties of building inspection companies when inspecting construction works, they do not perform inspections related to occupational health and safety. As can be seen from the Elmeri safety index results, more than half of the observed constructions remained below the 60% limit. In this context, we believe that the preparation of checklist forms for different building branches and the creation of the infrastructure for the ELMERI^{construction} safety index of these forms are a good start for the work to be done in this area.

In undergraduate education and training practices, occupational health and safety courses in engineering faculties and related vocational schools should be considered as one of the main courses and this awareness should

be given to the student. Enrollment of technical personnel, bosses and employees of building inspection companies, through professional chambers, on occupational health and safety, will provide an environment for the formation of a safety culture in working life faster. The point to be reached in terms of safety culture will be beneficial for the building inspection company to see occupational health and safety standards as one of its main duties and to minimize its responsibility in the formation of work accidents and occupational diseases with its faulty attitudes and behaviors in construction. Thus, the main goal will be to reduce work accidents in construction works and contribute to a safe working environment.

7. REFERENCES

- Brigham Young University, (2006), Risk Management & Safety, Excavation Program.
- Building Inspection Implementation Regulation, (Regulation Number: Official Gazette No. 26776; Date of Acceptance: 5.2.2008).
- Decision of the Constitutional Court, dated 13.01.2011, numbered 2007/2 E., 2011/13 K.
- Erdal, D. (2022). Responsibilities of Building Inspection Firms in terms of Occupational Health and Safety. (Thesis No. 761039) [Master's Thesis, Hitit University]. YÖK National Thesis Center
- Frank L. A. (2006). Occupational safety and health [online], <http://www.answers.com/topic/advisory-committee-on-construction-safety-andhealth-accesh>
- Kilkis, I. , Demir, S. (2012). An Investigation on the Employer's Obligation to Provide Occupational Health and Safety Training. *Journal of Labor Relations*, 3(1), 23-47. <https://dergipark.org.tr/en/pub/cider/issue/29525/316928>
- Korkmaz, A. & Avsalli, H. (2012). A New Era in Working Life: Occupational Health and Law No. 6331. *Süleyman Demirel University Faculty of Arts and Sciences Journal of Social Sciences*, 2012(26), 153-167. <https://dergipark.org>
- Korkut, G. & Trigger, A. (2013). Innovations and Basic Problems Brought by the Occupational Health and Safety Law No. 6331. *Journal of the Faculty of Economics and Administrative Sciences of Süleyman Demirel University*, 18(3), 455-474. <https://dergipark.org.tr/en/pub/sduiibfd/issue/20817/222750>
- Law No. 4708 on Building Inspection
- Ministry of Labor and Social Security, (2016). *Construction Sector Occupational Safety Handbook*, (Publication No: 44), Ankara. https://www.csgb.gov.tr/medias/6002/2011_44.pdf
- OHS Law (2012). OHS Law No. 6331, Official Gazette dated 30.06.2012 and numbered 28339
- T.R. Ministry of Labor and Social Security, Labor Inspection Board. Research Report. "The Report on the Analysis of Fatal Occupational Accidents in the Construction Sector and the Evaluation of Statistical Information for the Years 2014, 2015 and 2016".
- TURKSTAT (2018), Turkey with Statistics. Turkish Statistical Institute, Publication No: 27755, Ankara.
- Zoning Law No. 3194 Official Gazette No. 18749 dated 03.05.1985

“

Chapter 17

**DIGITAL TRANSFORMATION BASED ON
SWOT ANALYSIS FOR THE WIDESPREAD
USE OF MACHINE LEARNING METHODS IN
CONSTRUCTION PROJECT MANAGEMENT**

Osman BALLI¹

İlkim GÜVEN²

”

1 Arş. Gör., Malatya Turgut Özal Üniversitesi Mühendislik ve Doğa Bilimleri
Fakültesi Bilgisayar Mühendisliği Bölümü E-mail: osman.balli@ozal.edu.tr

2 Arş. Gör., Malatya Turgut Özal Üniversitesi Sanat Tasarım ve Mimarlık
Fakültesi Mimarlık Bölümü

1. Introduction

The reasons for the lack of digitalization and technological adoption in the construction industry are issues such as cost inefficiencies, delays in projects, poor performance, lack of sufficient information, and low occupational safety standards (Nikas et al., 2007). Automation in architecture and engineering is the process of using computers to enable tasks such as design, construction, installation, fabrication, and materials to be performed automatically, without human supervision. This industry is moving towards more automation to increase productivity (Mohammadpour et al., 2015).

The construction industry is one of the lagging industries in the world in terms of digitalization and is resisting digital transformation (Young et al., 2021). With the emergence of the fourth industrial revolution with Industry 4.0, artificial intelligence methods based on automation and data-based technologies have started to be used in industries (Yao et al., 2017). In this way, the use of artificial intelligence has become widespread in increasing construction efficiency and performance (Alheeti and Aldaiyat, 2021).

Artificial intelligence uses computers and solves problems to complete tasks that require human intelligence (Karan et al., 2020). Artificial intelligence quickly advanced based on human intelligence before long. It improves the quality, efficiency, and reliability of the construction site (Clavero, 2019). With advanced deep learning algorithms, the main causes of problems such as design flaws, project delays, cost overruns, contract disputes in the construction industry, and preventive measures can be analyzed (Karki and Hadikusumo, 2021).

The adoption of artificial intelligence technologies in the construction industry has contributed to solving problems that traditional approaches cannot solve by improving automation and helping to provide better competitive advantages (Chien et al., 2020). With the use of deep learning, many problems can be solved with methods such as object recognition and process monitoring that can improve the construction cycle (Khallaf and Khallaf, 2021). A processing architecture is used in which reasoning is provided by cognitive machines to make decisions and learn from old data during the challenging stages of construction projects (Karan et al., 2020). On the other hand, it is clear that there are barriers to the adoption of AI applications in the construction industry (Abioye et al., 2021). To this end, this study will conduct a SWOT analysis that addresses the strengths, weaknesses, opportunities, and threats of using AI applications in the construction industry.

This study is important for the work of industry stakeholders in future

projects. Those who take early action on artificial intelligence technologies will pioneer the course of this technology in the construction industry and will gain an advantage (Alheeti and Aldaiyat, 2021).

2. Methodology

This study investigated the issue of construction project management in the context of artificial intelligence, one of the new digital technologies, by considering the publications covering the years 2012-2022. As a result of this research, the information about the mentioned integration was handled with a SWOT analysis.

SWOT analysis is a structured evaluation method that generally evaluates the strengths, weaknesses, opportunities, and threats of a process (Leiber, 2017). The schematic representation of the SWOT analysis is given in Table 1.

	HELPFUL	HARMFUL
INTERNAL	STRENGTHS	WEAKNESSES
	attributes that are helpful in achieving the objective	attributes that are harmful to achieving the objective
EXTERNAL	OPPORTUNITIES	THREATS
	external conditions: helpful to achieving the objective	external conditions: harmful to achieving the objective

Table 1. Schematic representation of SWOT analysis (Leiber et al., 2018)

The topics evaluated in SWOT analysis are developed and aspects not noticed by other analysis tools are discovered (Leiber, 2017).

3. Use of Artificial Intelligence Methods in Construction Project Management

In this section, there is a SWOT analysis of the use of artificial intelligence in project management in the construction industry. Table 2 shows the SWOT analysis of this study.

STRENGTHS	WEAKNESSES
<ul style="list-style-type: none"> • improving damage assessment • improving efficiency and productivity • enhancing accuracy and reliability • reducing costs • reducing management and contract risks • provide time management • reducing health and safety risks • construction waste management 	<ul style="list-style-type: none"> • High costs and barriers to entry • limited data and knowledge • errors of AI predictions
OPPORTUNITIES	THREATS
<ul style="list-style-type: none"> • preservation of functional use of materials in construction • developing new products and service • improving stakeholder and labour satisfaction and loyalty • creating new career and learning opportunities • supported management process. 	<ul style="list-style-type: none"> • Technological threats • Not adopting technology

Table 2. SWOT analysis

4.1. Strength Analysis

When we look at the strengths of the inclusion of machine learning methods in construction project management processes, we can examine these features under eight headings: improving damage assessment, improving efficiency and productivity, enhancing accuracy and reliability, reducing costs, reducing management and contract risks, provide time management, reducing health and safety risks, construction waste management.

Improving Damage Assessment:

Artificial intelligence techniques are used to detect cracks and defects in concrete structures (Khallaf and Khallaf, 2021; Kim et al., 2020). Pattern recognition, which is one of the artificial intelligence techniques, it produces a valuable application by extracting features with images or videos for pattern recognition in construction projects, infrastructure condition assessment, ensuring the safety of the construction, detecting damage, and identifying unsafe situations (Pan and Zhang, 2021).

Improving Efficiency and Productivity:

Construction site data is created, collected, stored, and analyzed by providing construction site analytics using AI technologies (Lin et al., 2021). It is seen that artificial intelligence techniques will revolutionize the construction industry for a more reliable, automatic, self-updating, time-saving, and cost-effective construction process (Pan and Zhang, 2021). Various artificial intelligence forecasting models have been used

in the estimation of issues that require efficiency such as quality, infrastructure, and logistics in construction projects (Asadi et al., 2015; Kaya, 2014; Rafiei and Adeli, 2016). According to the study of Karan et al., artificial intelligence technologies can be used in the stages of writing a project scope, selecting employees, selecting sub-contractors, managing the construction budget, developing a project schedule, and enforcing safety procedures (Karan et al., 2020). The supply chain is an important factor in the construction industry. However, the high cost of information technologies and the lack of region-specific measurements prevent this chain. The aforementioned problems in the supply chain can be solved with AI techniques (Oyedele and Tham, 2007). Karki and Hadikusumo determined the competency factors of project managers for the successful completion of projects and automated this with a machine-learning approach (Karki and Hadikusumo, 2021). Machines that are not used effectively in construction can cause carbon emissions as well as increase the cost of the project. With the activity recognition service, deep learning can program when and why machines are used or not (Jacobsen and Teizer, 2022).

Enhancing Accuracy and Reliability:

Machines with artificial intelligence are used in the mapping phase required for construction. Correctly calculated three-dimensional maps produced with these machines are used to create blueprints and construction plans (Karki and Hadikusumo, 2021).

Reducing Costs:

Cost overruns of construction projects are due to the complexity and uncertainties in the project system (Pehlivan and Özt Demir, 2018). Various AI methods are used to solve cost overruns (Afzal et al., 2021). AI-based forecasting models are used in the construction industry and are effective in estimating construction cost and duration, which is one of the project success factors (Sridarran et al., 2017). Artificial intelligence, IoT, and robotics developments have the potential to reduce building costs by 20% (Alheeti and Aldaiyat, 2021). In addition, costs are reduced by increasing the predictability of transportation with artificial intelligence technology (Chung and Ashuri, 2022). With the inclusion of artificial intelligence in project management, financial managers can provide instant answers when spending less or more than expected according to the progress of the projects and processes can be measured in real-time. In this way, companies can even escape from bankruptcy (Abioye et al., 2021).

Reducing Management and Contract Risks:

While making cost-risk assessments in construction projects, the measurements of risks are based on subjective judgments. In addition, it takes

time to obtain sufficient risk data from industry experts (Afzal et al., 2021). It is also necessary to estimate the cost of a construction project in an accurate range. Barriers to cost estimation can be solved by AI methods (Elmoussalami, 2020). AI-based hybrid methods are used for risk identification, risk assessment, and risk prioritization in the construction industry (Abdelgawad and Fayek, 2012). Choi et al. created a machine-learning model for risk management. In this way, risk item extraction has achieved an accuracy rate of up to 92% (Choi et al., 2021). Chou et al. proposed a hybrid artificial intelligence algorithm to provide conflict prediction between the parties in the early stages of public-private partnership projects (Chou et al., 2014).

Provide Time Management:

Detection and estimation of these delays are important for project management processes, as undesirable delays in the construction industry will cause problems such as low productivity and cost overrun (Pan and Zhang, 2021). Employers need access to accurate information about construction time before project processes begin. With this determination, projects provide a specific flow plan (Gab-Allah et al., 2015). Gondia et al. have succeeded in proposing an artificial intelligence and machine learning-based approach to project delays in the construction industry (Gondia et al., 2020). The use of neural networks is important for accurate estimates of project duration (Al-Zubaidi et al., 2019). With artificial intelligence technology, production downtime in the project process is reduced (Chung and Ashuri, 2022). In addition, the existence of an artificial intelligence algorithm, which ensures that the structural systems of the buildings are evaluated in accordance with the regulations, accelerates the revision processes of architectural projects (Bingöl et al., 2020).

Reducing Health and Safety Risks:

There are more occupational injuries in the construction industry compared to other industries (Winge et al., 2019). This leads to a loss of reputation, decreased productivity, increased insurance premiums, litigation, and claims costs. For this reason, it is possible to predict accidents and risks that may occur in construction with the help of AI technology (Abioye et al., 2021). Alheeti and Aldaiyat have been successful in offering an online risk monitoring system based on artificial intelligence to support construction management in civil engineering (Alheeti and Aldaiyat, 2021). Artificial intelligence controls the rigidity and center of gravity of the buildings based on the torsional irregularities in the earthquake code (Yurtcu and Özocak, 2016). In this way, it provides more accurate productions by evaluating the risks of buildings in terms of earthquakes.

Construction Waste Management

The construction industry is inadequate in the management of construction and demolition waste. For this purpose, artificial intelligence is needed for the management of waste generated in the construction. Ali et al. have achieved success with their proposed AI-based system for the management of waste in construction (Ali et al., 2019).

4.2. Weakness Analysis

Although the use of machine learning methods in construction project management processes has many strengths, it also has weaknesses (Abioye et al., 2021). We can examine these weaknesses under three headings: High costs and barriers to entry, limited data and knowledge, and errors in AI predictions.

High Costs and Barriers to Entry:

The initial investment costs required to use artificial intelligence are very high. These costs cannot be met by small firms in the industry (Chui and Francisco, 2017).

Limited Data and Knowledge

The use of smart technology in the construction industry is practically in transition. For this reason, project managers may have insufficient knowledge on this subject and may not be aware of the effects of this ignorance (Zhu et al., 2022). There is a lack of datasets in the use of artificial intelligence in the construction industry. Successful implementation of AI goes through a trained algorithm, so the data should contain variations (Chung and Ashuri, 2022). AI is a new development trend in today's society, but businesses and governments do not fully understand its development and overestimate the commercial value of AI (Songand and Chen, 2021).

Errors

The prediction results of artificial intelligence productions may or may not be accurate. For this reason, there are risks such as cost, program, and security (Chung and Ashuri, 2022).

4.3. Opportunity Analysis

New technologies create many opportunities over conventional systems. Intelligent systems predict future events and conditions with predictive approaches. This includes problems such as machine failure (Caetano et al., 2020). In this way, the use of machinery, which is important in the processes in the construction industry, and the negativities to be experienced due to the interruption of this use can be prevented by AI. The opportunities AI technology creates for construction project management

are as follows: preservation of functional use of materials in construction, developing new products and services, improving stakeholder and labor satisfaction and loyalty, creation of new career and learning opportunities, and support management process.

Preservation of Functional Use of Materials in Construction:

Intelligent systems predict future events and conditions with predictive approaches. This includes problems such as machine failure (Caetano et al., 2020). In this way, the use of machinery, which is important in the processes in the construction industry, and the negativities to be experienced due to the interruption of this use can be prevented by AI. In addition, tile surface coatings used in construction are analyzed with AI-supported technologies and calculated geometrically, and opportunities such as improving their alignment can be provided (Lin and Fang, 2013).

Developing New Products and Services:

Artificial intelligence can be integrated with blockchain technology. Blockchain technology, on the other hand, has the potential to solve the problems of trust, communication, and transparency in the industry (Abi-oye et al., 2021). Source and waste optimization, value-oriented services, supply chain management, occupational health and safety, construction contracts, user interfaces, and inspection systems are some of them (Abi-oye et al., 2021). It can also improve project planning and scheduling when artificial intelligence technology is combined with BIM and 4D CAD technologies (Liu et al., 2018).

Improving Stakeholder and Labor Satisfaction and Loyalty

With the support of artificial intelligence, excess supply is reduced in construction management (Jacobsen and Teizer, 2022). Nguyen et al. proposed an artificial intelligence-based system that measures factors such as motivation, stress, and fatigue that determine the productivity of construction workers (Nguyen, 2022). Various detection devices are used to monitor the facilities in construction, and these devices monitor the performance of the system and send notifications to employers, preventing the loss of time and money in the project process. Bangaru et al. used various artificial intelligence techniques to describe activities in the scaffolding process in construction (Bangaru, 2021). Models using machine learning can classify actions such as bending, walking, and lifting. With this classification, uncertain actions can be classified according to whether they are safe or productive (Jacobsen and Teizer, 2022).

Creating New Career and Learning Opportunities

Re-qualification of workers is possible with the adoption of new technologies in the construction industry. As an example, with the development

of BIM technologies, new roles such as BIM project managers, directors, coordinators, and designers have emerged (Uhm, 2017).

Supported Management Process

There is a propensity for many errors in the management of construction processes and the issuance of contracts. The technology that will enable these processes to be regulated, accelerated and maintained more accurately than traditional methods is AI technology. Automation of contract management is provided with AI (Muhammad et al., 2019). Martínez-Rojas et al. stated that with appropriate data processing, decision-making processes in construction projects are facilitated and improved, thereby helping project management processes (Martínez-Rojas et al., 2016). With the optimization of the use of artificial intelligence, the strategy, operation, and planning stages of the projects can be formulated. Resources are better allocated, staffing can be arranged, facility locations are automatically determined, and these adjustments are made within reasonable timing (Pan and Zhang, 2021). Machine learning techniques can provide quality control with automatic progress tracking (Moud et al., 2018).

4.4. Threat Analysis

This integration brings with it various threats. These are the threats brought by technology and the threats brought by unacceptable technology.

Technological Threats

The systems that come with digitalization in the world lead to some cyber threats that are common in the construction industry. These are malware, social engineering, and phishing (Boyes, 2015). Although there are no specific implications for the construction industry in studies on cyber security, the rate of exposure of the construction industry to cybercrime has increased due to the widespread use of virtual systems and increased trust (Race, 2016). Artificial intelligence technologies can create various dangers when not included in construction site management properly. For example, how will a robot that breaks down at the construction site decide where it will fall and what kind of damage it will cause to a group of workers? (Abioye et al., 2021).

Not adopting the Technology

Some industries that value personal experience and expertise will not accept AI-powered technologies. For example, it is understandable to reject the use of machine learning methods in jobs such as chemical plants, manufacturing plants, and nuclear power plants (Hatami et al., 2021).

4. Findings and Conclusion

With the acceptance and spread of artificial intelligence technologies

in the construction industry, the initial investment costs, which are seen as a problem, will decrease. With the use of artificial intelligence, project implementers will prefer the use of new technologies in increasing the performance and efficiency of projects and will increase the chances of success of the projects (Kumar et al., 2022).

The results of the SWOT analysis of the use of artificial intelligence in the manufacturing industry revealed both strengths and challenges.

One of the key strengths of AI in manufacturing is its ability to increase efficiency and productivity. By automating certain tasks and processes, AI can help reduce the time and resources required to complete a task, resulting in greater output and cost savings. Another strength of artificial intelligence in production is reducing management and contract risks. Artificial intelligence helps plan the course of construction projects with the cost estimates it provides. In addition, it saves time and money thanks to the many long processes it facilitates. Reduce health and safety risks by contributing to occupational safety at construction sites. On the other hand, waste management processes that the construction industry is insufficient in can be solved with AI-based technology. As another strength of this application, damage detection can be added to construction projects. In addition, making calculations by computer increases the reliability of the processes.

However, the adoption of artificial intelligence in production also brings some challenges. The initial investment cost of this integration is high. In addition, there is not enough data and knowledge in the construction industry.

Considering the opportunities created by the use of artificial intelligence, it can be stated that the use of materials can be facilitated and managed first. In this way, new technologies can be developed, and the industry can be brought together with newer services. This integration provides several benefits for all stakeholders and simplifies the entire construction process management.

However, there are two threats to this integration, one being technology oriented. These are the threats brought by digitalization and the threats that occur due to the non-adoption of technology.

Overall, the use of AI in the manufacturing industry has the potential to deliver significant benefits in terms of efficiency, productivity, and data-driven decision-making. However, it is important for companies to carefully consider the costs and potential challenges associated with adopting AI and address any concerns or issues that may arise.

This study is a resource that includes the existing literature for future

studies as the construction industry transitions to smart technologies. As a result, although it is stated that it has difficulty in accepting innovations, the production industry will accept digital transformation over time. It is important for industries that adopt traditional methods, such as the construction industry, to seize the day so that they can continue to survive. For this reason, a SWOT analysis has been made on the use of artificial intelligence, which has just been included in the project management processes, and the application of machine learning technique, one of its sub-titles. An innovative perspective is essential for the industry to develop and adapt to new technologies. This paper presents a look at the integration of AI and project management, an integration that will enable the construction industry to keep up with the digital transformation that is taking place in all other industries.

References

- Abdelgawad, M. and Fayek, A. R. (2012). Comprehensive hybrid framework for risk analysis in the construction industry using combined failure mode and effect analysis, fault trees, event trees, and fuzzy logic, *Journal of Construction Engineering and Management*, Vol. 138 No. 5, pp. 642-651, 2012.
- Abioye, S. O., Oyedele, L. O., Akanbi, L., Ajayi, A., Davila Delgado, J. M., Bilal, M., Akinade, O. O., & Ahmed, A. (2021). Artificial intelligence in the construction industry: A review of present status, opportunities and future challenges. *Journal of Building Engineering*, 44(October), 103299.
- Afzal, F., Yunfei, S., Nazir, M. and Bhatti, S. M. A. (2021). A review of artificial intelligence-based risk assessment methods for capturing complexity-risk interdependencies: Cost overrun in construction projects. *International Journal of Managing Projects in Business*, 14(2), 300–328.
- Alheeti, K. M. A. & Aldaiyat, R. M. (2021). A new labour safety in construction management based on artificial intelligence. *Periodicals of Engineering and Natural Sciences*, 9(4), 685–691.
- Ali, T. H., Akhund, M. A., Memon, N. A., Memon, A. H., Imad, H. U. and Khahro, S. H. (2019). Application of Artificial Intelligence in Construction Waste Management. *Proceedings of 2019 8th International Conference on Industrial Technology and Management, ICITM 2019*, 50–55.
- Al-Zubaidi, E. D. A., Yas, A. H. and Abbas, H. F. (2019). Guess the time of implementation of residential construction projects using neural networks ANN. *Periodicals of Engineering and Natural Sciences*, 7 (3): 1218–1227.
- Asadi, A., Alsubaey, M. and Makatsoris, C. (2015). A machine learning approach for predicting delays in construction logistics, *International Journal of Advanced Logistics*, Vol. 4 No. 2, pp. 115-130.
- Bangaru, S. S. Wang, C., Busam, S. A. and Aghazadeh, F. (2021). ANN- based automated scaffold builder activity recognition through wearable EMG and IMU sensors. *Automation in Construction*. 126 (Jun).
- Bingöl, K., Akan, A. E., Örmecioglu H. T., and Er, A. (2020). Artificial intelligence applications in earthquake resistant architectural design: Determination of irregular structural systems with deep learning and Image AI method. *Journal of the Faculty of Engineering and Architecture of Gazi University*, 35(4), 2197–2209.
- Boyes, H. (2015). *Cybersecurity and cyber-resilient supply chains*, Technol. Innovation Manage. Rev. 5 (4) 28.
- Caetano, I., Santos, L. and Leitão, A. (2020). Computational design in architecture: Defining parametric, generative, and algorithmic design. *Frontiers of Architectural Research*, 9(2), 287–300.
- Chien, C.D.-P.S., Huh, W., Jang, Y., Morrison, Y. (2020). Artificial intelligence in manufacturing and logistics systems: algorithms, applications, and case

- studies, *Publication Cover Int. J. Prod. Res.* 58 (9) 2730–2731.
- Choi, S. J., Choi, S. W., Kim, J. H. and Lee, E. B. (2021). Ai and text-mining applications for analyzing contractor's risk in invitation to bid (ITB) and contracts for engineering procurement and construction (EPC) projects. *Energies*, 14(15), 2021.
- Chou, J. S., Cheng, M. Y., Wu, Y. W. and Pham A., D. (2014). Optimizing parameters of support vector machine using fast messy genetic algorithm for disjunctive classification. *Expert Systems with Applications*, 41(8), 3955–3964, 2014.
- Chui, M. and Francisco, S. (2017). *Artificial Intelligence the Next Digital frontier?* McKinsey and Company Global Institute, 2017.
- Chung, F. and Ashuri, B. (2022). Applicability of Artificial Intelligence (AI) Methods to Construction Manufacturing: A Literature Review. *Construction Research Congress 2022: Project Management and Delivery, Controls, and Design and Materials - Selected Papers from Construction Research Congress 2022*, 3–C, 964–973.
- Chung, F. and Ashuri, B. Applicability of Artificial Intelligence (AI) Methods to Construction Manufacturing: A Literature Review. *Construction Research Congress 2022: Project Management and Delivery, Controls, and Design and Materials - Selected Papers from Construction Research Congress 2022*, 3–C, 964–973.
- Clavero, J. (2019). Applications for Artificial Intelligence in Construction Management. <https://esub.com/construction-project-management-software-blog/applications-artificial-intelligence-construction-management/>
- Elmousalami, H. H. (2020). Artificial Intelligence and Parametric Construction Cost Estimate Modeling: State-of-the-Art Review. *Journal of Construction Engineering and Management*, 146(1), 2020.
- Gab-Allah, A. A., Ibrahim, A. H. and Hagra, O. A. (2015). Predicting the construction duration of building projects using artificial neural networks. *International Journal of Applied Management Science*. 7 (2): 123–141.
- Gondia, A. Siam, A., El-Dakhkhni, W. and Nassar, A. H. (2020). Machine Learning Algorithms for Construction Projects Delay Risk Prediction. *Journal of Construction Engineering and Management*, 146(1), 1–16.
- Hatami, M., Franz, B., Paneru, S. & Flood, I. (2021). *Using Deep Learning Artificial Intelligence to Improve Foresight Method in the Optimization of Planning and Scheduling of Construction Processes*. 811–818, 2021.
- Jacobsen, E. L. and Teizer, J. (2022). Deep Learning in Construction: Review of Applications and Potential Avenues. *Journal of Computing in Civil Engineering*, 36(2), 1–12.
- Karan, E., Asgari, S. & Mohammadpour, A. (2020). Applying Artificial Intelligence within the AEC Industry: Collecting and Interpreting Data. *Con-*

struction Research Congress 2020: Computer Applications - Selected Papers from the Construction Research Congress 2020, 007(1994), 792–801, 2020.

- Karki, S and Hadikusumo, B. (2021). Machine learning for the identification of competent project managers for construction projects in Nepal. *Construction Innovation*.
- Kaya, M., Keleş, A. and Oral, E. (2014). Construction crew productivity prediction by using data mining methods, *Procedia - Social and Behavioral Sciences*, vol. 141, p. e12491253, 2014.
- Khallaf, R. and Khallaf, M. (2021). Classification and analysis of deep learning applications in construction: A systematic literature review. *Automation in Construction*, 129(May), 103760.
- Kim, J. J., Kim, A. R. and Lee, S. W. (2020). Artificial Neural Network-Based Automated Crack Detection and Analysis for the Inspection of Concrete Structures. *Applied Sciences*, Multidisciplinary Digital Publishing Institute, 10(22), 8105.
- Kumar, V., Pandey, A., and Singh, R. (2022). Can Artificial Intelligence be a Critical Success Factor of Construction Projects? Project practitioners' perspectives. *Technology Innovation Management Review*, 11(11–12), 17–32.
- Leiber, T. (2017). Computational Social Science and Big Data: A Quick SWOT Analysis. In *Berechenbarkeit der Welt? Philosophie und Wissenschaft im Zeitalter von Big Data [Computability of the World? Philosophy and Science in the Age of Big Data]*, edited by Joerg Wernecke, Wolfgang Pietsch, and Maximilian Ott, 287–301. Berlin: Springer.
- Leiber, T., Stensaker, B. and Harvey, L. C. (2018). Bridging theory and practice of impact evaluation of quality management in higher education institutions: a SWOT analysis. *European Journal of Higher Education*, 8(3), 351–365.
- Lin, K. L. and Fang, J. L. (2013). Applications of computer vision on tile alignment inspection. *Automation in Construction*, 35, 562–567.
- Lin, Z., Chen, A. & Hsieh, S. (2021). *Temporal image analytics for abnormal construction activity identification*, *Automation in Construction*. 124, 103572.
- Liu, N., Kang, B. G. and Zheng, Y. (2018). Current trend in planning and scheduling of construction project using artificial intelligence. *IET Conference Publications*, 2018(CP754), 1–6.
- Martínez-Rojas, M., Marín, N. and Vila, M. A. (2016). The Role of Information Technologies to Address Data Handling in Construction Project Management. *Journal of Computing in Civil Engineering*, 30(4), 1–20.
- Mohammadpour, A., Karan, E., Asadi, S. & Rothrock, L. (2015). Measuring end-user satisfaction in the design of building projects using eye-tracking technology. *International Workshop on Computing in Civil Engineering*, Seattle, WA, 564-571.

- Moud, H. I., Shojaei, A., Flood, I., Zhang, X. and Hatami, M. (2018). Qualitative and Quantitative Risk Analysis of Unmanned Aerial Vehicle Flights over Construction Job Sites, *International Journal on Advances in Intelligent Systems*, vol 12 no 3 & 4.
- Muhammad, K. Saoula, O., Issa, M., Ahmed, U. (2019). Contract management and performance characteristics: an empirical and managerial implication for Indonesia, *Management Science Letters*, 9 (8) 1289–1298.
- Nguyen, P., Fayek A. R. and Hamzeh, F. (2022). A Sensor-Based Empirical Framework to Measure Construction Labor Productivity. *Construction Research Congress 2022: Project Management and Delivery, Controls, and Design and Materials - Selected Papers from Construction Research Congress 2022*, 3–C, 964–973.
- Nikas, A., Poulymenakou, A. & Kriaris, P. (2007). Investigating antecedents and drivers affecting the adoption of collaboration technologies in the construction industry, *Automation in Construction*. 16 (5) 632–641.
- Oyedele, L. O. Tham, K. W. (2007). Clients “assessment of architects” performance in building delivery process: Evidence from Nigeria, *Building and Environment*. 42 (5) 2090–2099.
- Pan, Y and Zhang, L. (2021). Roles of artificial intelligence in construction engineering and management: A critical review and future trends. *Automation in Construction*, 122(November 2020), 103517.
- Pehlivan, S and Öztimir, A. E. (2018). Integrated risk of progress-based costs and schedule delays in construction projects, *Engineering Management Journal*, Vol. 30 No. 2, pp. 108-116.
- Race, S. (2016). *Construction Manager's BIM Handbook*, in: *Cyber Security*, John Wiley & Sons Ltd, Chichester (West Sussex), 107–112.
- Rafiei, M. and Adeli, H. (2016). A novel machine learning model for estimation of sale prices of real estate units, *Journal of Construction Engineering and Management*, Vol. 142 No. 2, p. e04015066.
- Songand, M. and Chen, X. (2021). Construction of Enterprise Business Management Analysis Framework in the Development of Artificial Intelligence. *Proceedings - 2021 International Conference on Computer Information Science and Artificial Intelligence, CISAI 2021*, 689–692.
- Sridarran, P., Keraminiyage, K. and Herszon, L. (2017). Improving the cost estimates of complex projects in the project-based industries, *Built Environment Project and Asset Management*, Vol. 7 No. 2, pp. 173-184, 2017.
- Uhm, M., Lee, G. Jeon, B. (2017). An analysis of BIM jobs and competencies based on the use of terms in the industry, *Automation in Construction*. 81, 67–98.
- Winge, S., Albrechtsen, E., Mostue, B. A. (2019). Causal factors and connections in construction accidents, *Safety Science*. 112, 130–141.

- Yao, X., Zhou, J., Zhang, J., Bo'er, C.R. (2017). From Intelligent Manufacturing to Smart Manufacturing for Industry 4.0 Driven by Next Generation Artificial Intelligence and Further on, *5th International Conference on Enterprise Systems*, Beijing, (ES).
- Young, D., Panthi, K., Noor, O. (2021). Challenges involved in adopting BIM on the construction jobsite, *EPiC Series in Built Environment*, 2, 302–310.
- Yurtcu, Ş., Özocak, A. (2016). Prediction of compression index of fine-grained soils using statistical and artificial intelligence methods, *Journal of the Faculty of Engineering and Architecture of Gazi University*, 31 (3), 597-608.
- Zhu, H., Hwang, B. G. Ngo, J. and Tan, J. P. S. (2022). Applications of Smart Technologies in Construction Project Management. *Journal of Construction Engineering and Management*, 148(4), 1–12, 2022.

“

Chapter 18

ELECTRICAL CIRCUIT THEOREMS AND SIMULINK ANALYSIS

Hilmi Zenk¹

Faruk GÜNER²

”

1 Doç.Dr. Hilmi Zenk, <https://orcid.org/0000-0002-1653-8580>, Dep.of Electrical and Elec. Eng., Giresun University, 28200 Giresun, Turkey.

2 Doç.Dr.Faruk Güner, <https://orcid.org/0000-0002-3438-0553>, Department of Mechanical Engineering, Giresun University, 28200 Giresun, Turkey.

1. Introduction

In this section, the basic circuit theorems, which are widely used in the analysis and solution of electrical circuits, are examined theoretically and in Matlab/Simulink environment. These theorems are respectively; Superposition, Thevenin, Norton and Maximum Power Transfer Theory [1-9]. Detailed analysis of electrical circuit theorems is also very important when designing an effective control system. These control systems can be proportional (P), proportional-integrative (PI), proportional-integrative-derivative (PID) or fuzzy logic based [10-13].

2. Superposition Theorem

It is a theory used in solving linear electrical circuits with more than one electrical source (current or voltage). These resources can be dependent or independent. The difference of the superposition theorem from other theorems is that the effects of the sources on the circuit are examined one by one. This feature in the superposition theorem provides an advantage in the calculation of current and voltages in the circuit without the need for long mathematical operations such as matrix and determinant, according to the analysis with the perimeter and node methods [14].

The superposition theorem is the mathematical sum of the effects of all sources in a circuit on any circuit element. Therefore, while examining the effect of a source on the circuit, other sources should be silenced. Silencing the sources in the circuit means that the current sources are deactivated and their ends are open circuit, the voltage sources are deactivated and their ends are short-circuited. If the welds have internal resistance, they should stay in place. Similarly, during the analysis, the dependent sources also remain in their places in the circuit. After the effect of one resource is calculated, the process is repeated for the other resource. The number of repetitions depends on the number of resources in the circuit. The individually calculated effects of all independent sources are summed up taking into account polarity. In this respect, the name of this theory is also known as the Theory of Sociality.

In summary;

- 1- Current/voltage sources in the circuit are determined and independent sources are determined and numbered.
- 2- Other independent sources are muted so that only one independent source remains on the circuit at a time.

3- According to the source to be left alone, the current or voltage value to be obtained in the circuit is calculated.

4- These current or voltage values, which are calculated one by one for all independent sources, are added considering the current direction / voltage polarity. In this respect, the name of this theory is also known as the Theory of Sociality [1-9].

Example 1: Calculate the current flowing through the resistor R_2 in the circuit in Figure-1 with the help of the Superposition Theorem.

Solution: Two separate circuits are drawn to understand the effect of current and voltage sources in the given circuit. The influence of these two sources on the current flowing through the individual resistor R_2 is I_2' and I_2'' , respectively.

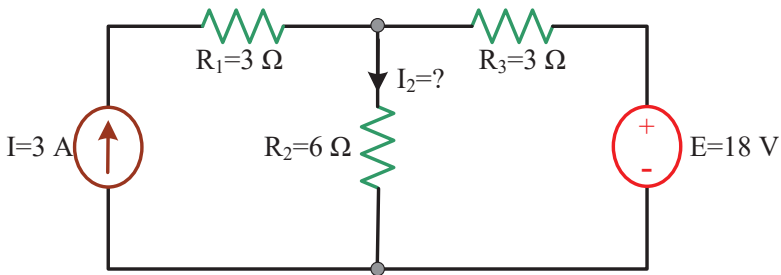

Figure-1

When only I current source is active in the circuit; If the other source in the circuit, the E voltage source, is muted as shown in Figure-2, that is, if it is disconnected and its ends are short-circuited, the effect of the current source I on the current flowing through the R_2 resistor I_2' is calculated.

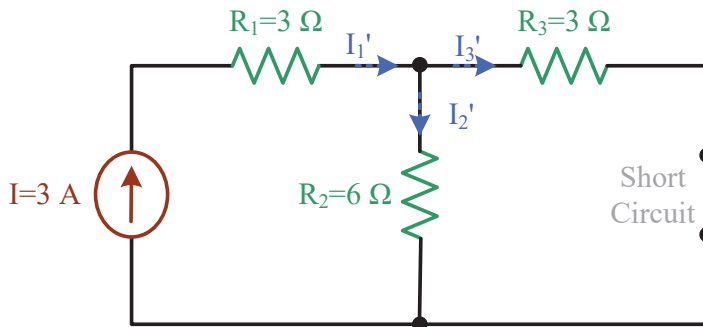

Figure-2

$$I_1' = I = 3 \text{ A}$$

$$I_2' = I_1' \frac{R_3}{(R_2 + R_3)} = 3 \frac{3}{(6+3)} = 1 \text{ A}$$

When only E voltage source is active in the circuit; If the I current source, which is the other source in the circuit, is silenced as shown in Figure-3, that is, if it is deactivated and its ends are open-circuited, the effect of the E current source on the current passing through the R₂ resistor I₂' is calculated.

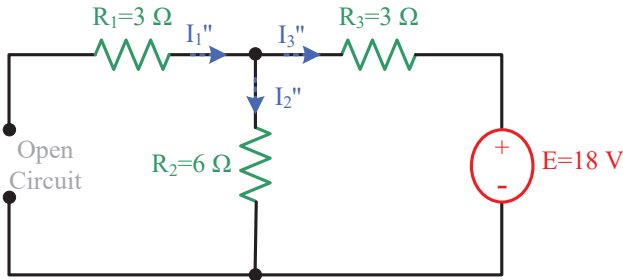

Figure-3

$$I_2'' = -I_3'' = E \left[\frac{1}{(R_2 + R_3)} \right] = 18 \left[\frac{1}{(3 + 6)} \right] = 2 \text{ A}$$

Result: It is summed up considering the directions of the I₂ currents calculated separately for both sources. The calculated I₂' and I₂'' currents are added together because they are in the same direction.

$$I_2 = I_2' + I_2'' = 1 + 2 = 3 \text{ A}$$

If the Simulink simulation of the circuit is made;

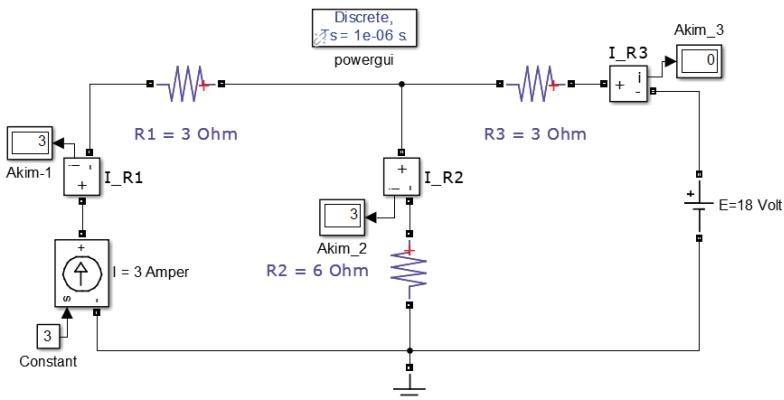

Figure-4

2.1 Superposition Theorem Power Calculation

Let us consider by examining the previous example of the Superposition Theorem Power Calculus. Actual power dissipated in resistor R_2 ;

$$P_2 = I_2^2 \cdot R_2 = 3^2 \cdot 6 = 54 \text{ W } (*)$$

The forces created by the I_2' and I_2'' currents calculated by the Superposition Theorem;

$$P_2' = (I_2')^2 \cdot R_2 = 1^2 \cdot 6 = 6 \text{ W}$$

$$P_2'' = (I_2'')^2 \cdot R_2 = 2^2 \cdot 6 = 24 \text{ W}$$

$$P_2 = P_2' + P_2'' = 6 + 24 = 30 \text{ W } (**)$$

is found. From here, it is seen that the real power (*) consumed in the R_2 resistor and the power (**) value created by the currents calculated with the Superposition Theorem are not the same. This is because the power formula is quadratic. The Superposition Theorem can only be used for first-order functions.

Example 2: Find the currents flowing through the resistors in the circuit given in Figure-5 with the Superposition theorem.

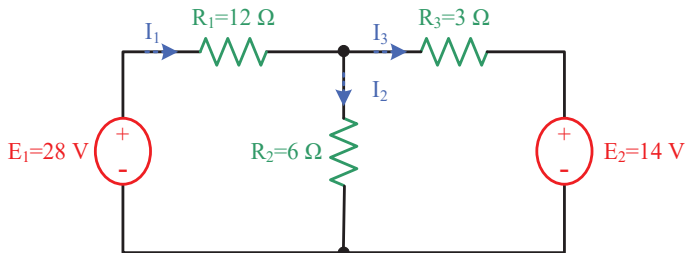

Figure-5

Solution: Two separate circuits are drawn to understand the effect of two voltage sources alone in the circuit. When only E_1 voltage source is active in the circuit; If the other source in the circuit, the E_2 voltage source, is silenced as shown in Figure-6, that is, if it is deactivated and its terminals are short-circuited,

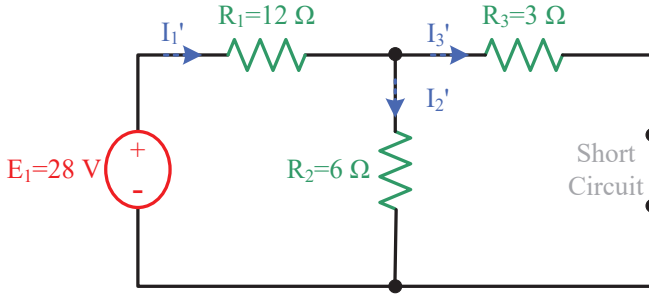

Figure-6

$$R_{23} = R_2 \parallel R_3 \quad \Rightarrow \quad R_{23} = \frac{R_2 \cdot R_3}{(R_2 + R_3)} = \frac{6 \cdot 3}{(6 + 3)} = 2 \Omega$$

$$R_{es'} = R_1 + R_{23} = (12 + 2) = 14 \Omega$$

$$I_1' = \frac{E_1}{R_{es'}} = \frac{28}{14} = 2 A$$

$$I_2' = I_1' \cdot \left(\frac{R_3}{R_2 + R_3}\right) = 2 \cdot \frac{3}{(6 + 3)} = 0,667 A$$

$$I_3' = I_1' \cdot \left(\frac{R_2}{R_2 + R_3}\right) = 2 \cdot \frac{6}{(6 + 3)} = 1,333 A$$

When only E_2 voltage source is active in the circuit; If the E_1 voltage source, which is the other source in the circuit, is silenced as shown in Figure-7, that is, if it is deactivated and its terminals are short-circuited,

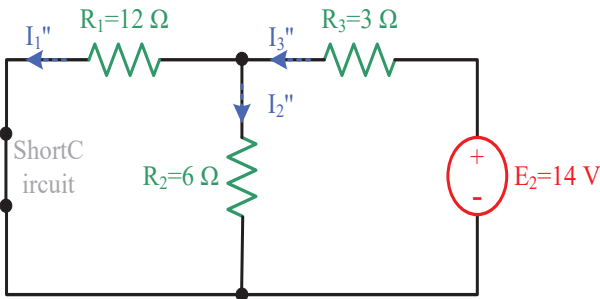

Figure-7

$$R_{12} = R_1 \parallel R_2 \quad \Rightarrow \quad R_{12} = \frac{R_1 \cdot R_2}{(R_1 + R_2)} = \frac{12 \cdot 6}{(12 + 6)} = 4 \Omega$$

$$R_{es''} = R_3 + R_{12} = (3 + 4) = 7 \Omega$$

$$I_3'' = \frac{E_2}{R_{e_s''}} = \frac{14}{7} = 2 \text{ A}$$

$$I_1'' = I_3'' \cdot \left(\frac{R_2}{R_1 + R_2} \right) = 2 \cdot \frac{6}{(12 + 6)} = 0,667 \text{ A}$$

$$I_2'' = I_3'' \cdot \left(\frac{R_1}{R_1 + R_2} \right) = 2 \cdot \frac{12}{(12 + 6)} = 1,333 \text{ A}$$

Result: If the directions of the currents calculated separately for each source are added together;

a) The direction of the current I_1 is the same as I_1' but opposite to I_1'' ;

$$I_1 = I_1' - I_1'' = 2 - 0,667 = 1,333 \text{ A}$$

b) the direction of the current I_2 is the same as I_2' and I_2'' ;

$$I_2 = I_2' + I_2'' = 0,667 + 1,333 = 2 \text{ A}$$

c) The direction of the current I_3 is the same as I_3' but opposite to I_3'' ;

$$I_3 = I_3' - I_3'' = 1,333 - 2 = -0,667 \text{ A}$$

is found.

d) Simulink simulation of the circuit;

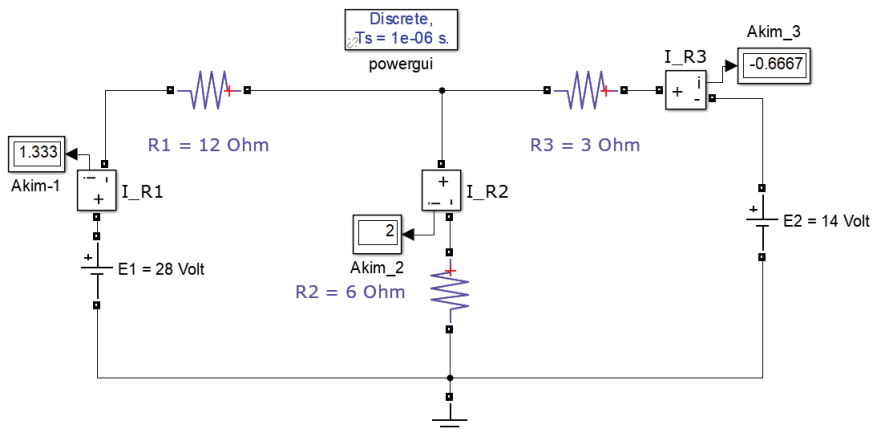

Figure-8

Example 3: Calculate the value of the current i_x defined in the circuit in Figure-9 with the help of the superposition Theorem.

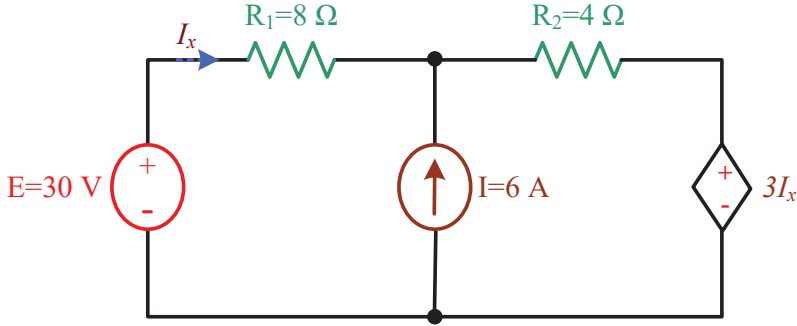

Figure-9

Solution: There are 2 independent and 1 dependent sources in the circuit. The effect of the 30 V voltage source on the circuit is calculated by making the 6 A current source open circuit. The dependent source remains in the circuit as it is. When only E voltage source is active in the circuit;

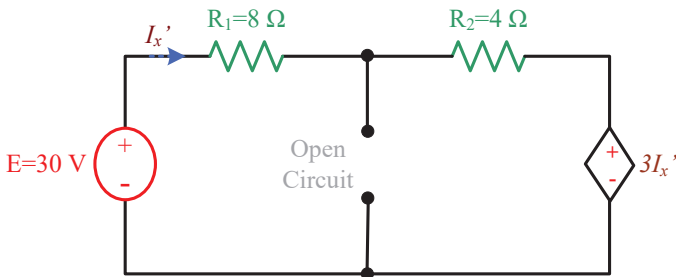

Figure-10

If Kirchhoff Voltage Law (KVL) is applied to the circuit:

$$-E + I_x' \cdot R_1 + I_x' \cdot R_2 + 3 \cdot I_x' = 0$$

$$-30 + I_x' \cdot 8 + I_x' \cdot 4 + 3 \cdot I_x' = 0$$

$$15 \cdot I_x' = 30$$

$$I_x' = 2 \text{ A}$$

When only I current source is active in the circuit;

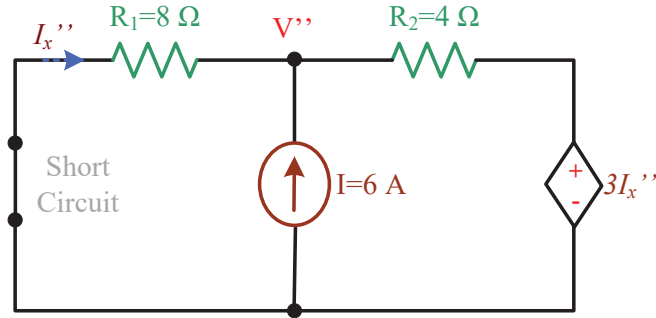

Figure-11

If Kirchoff Current Law (KCL) is applied to the node in the circuit;

$$I_x'' = -\left(\frac{V''}{R_1}\right)$$

$$-I_x'' - I + \left(\frac{V'' - 3I_x''}{R_2}\right) = 0$$

$$\left(\frac{V''}{R_1}\right) - 6 + \left(\frac{V'' + 3\left(\frac{V''}{R_1}\right)}{R_2}\right) = \left(\frac{V''}{8}\right) - 6 + \left(\frac{V'' + 3\left(\frac{V''}{8}\right)}{4}\right) = 0$$

$$3V'' + \left(\frac{6 \cdot V''}{8}\right) = 48$$

$$\left(\frac{15 \cdot V''}{4}\right) = 48$$

$$V'' = 12,8 \text{ V}$$

$$I_x'' = -\left(\frac{V''}{R_1}\right) \text{ ise } I_x'' = -\left(\frac{12,8}{8}\right) = -1,6 \text{ A}$$

Since the direction of the current I_x is the sum of I_x' and I_x'' ;

$$I_x = I_x' + I_x'' = 2 - 1,6 = 0,4 \text{ A}$$

is found.

d) Simulink simulation of the circuit;

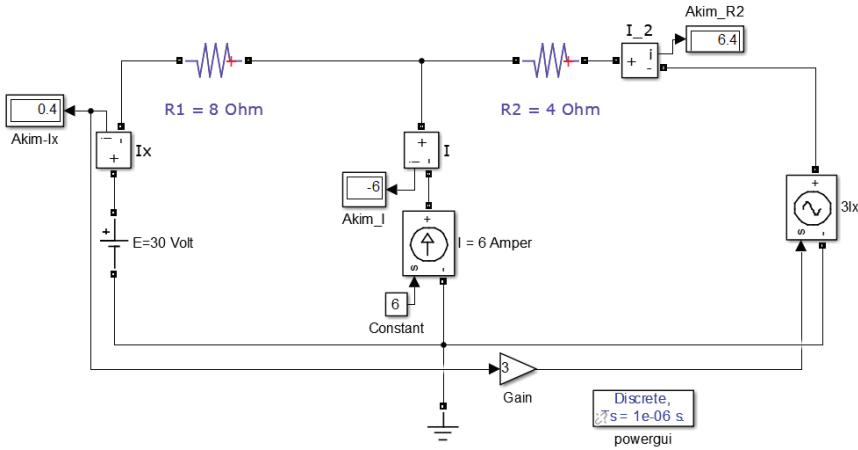

Figure-12

3. Thevenin Theorem

Thevenin's theorem; It is a method that facilitates linear circuit solutions fed by one or more voltage sources. In this method, the most complex electrical circuits are easily solved, as the current or voltage passing through any part of the circuit allows to find other parts of the circuit without calculating. Thevenin Equivalent is very widely used when generating many electrical theorems [15]. Thevenin's theorem makes a unique contribution when modeling batteries for electric vehicles [16-17]. Thevenin's theorem, a voltage source according to any two ends of an electrical circuit consisting of linear resistance and sources, and the series resistance to this source is called Thevenin equivalent circuit. Thevenin equivalent circuit is a real voltage source model as shown in Figure-13.

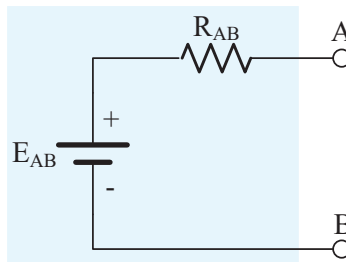

Figure-13 General Demonstration of Thevenin Equivalent Circuit

E_{AB} represents the ideal voltage source value (emf) and R_{AB} represents the internal resistance of the voltage source. The value and direction of the

voltage source depend on the elements in the original circuit at the beginning.

3.1 Analysis of Electrical Circuits by Converting to Thevenin Equivalent Circuit

When a resistor R_y is connected to an electrical circuit as in Figure-14 a), if the current I_y passing through this resistor is found using Thevenin's Theorem,

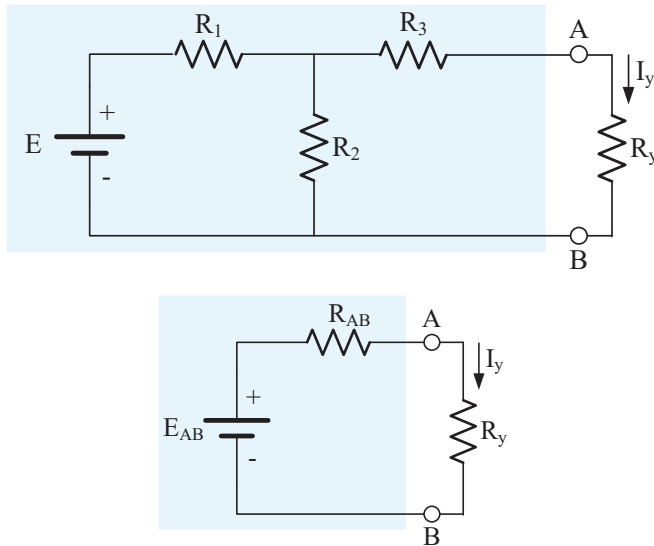

Figure-14 a) Original Circuit b) Thevenin Equivalent Circuit

Required steps to obtain Thevenin equivalent circuit

- The terminals connected to the resistor R_y in the circuit are marked as A and B.
- After this marking, the R_y resistor is deactivated.
- The place is made open circuit.
- Look at the original circuit inside the scanned area from the open ends of A-B.
- The circuit is calculated as it looks.
- After the Thevenin equivalent of the circuit in the shaded area is found, the previously removed R_y resistor is reconnected to the circuit.
- Circuits in both shaded areas are equivalent to each other.
and is defined as follows.

a) Finding the Thevenin equivalent voltage value (E_{AB})

When a resistor is connected to the terminals named A and B of any circuit as in Figure-15 a), the open circuit voltage E_{AB} must be calculated to calculate the current flowing through this resistor. This voltage is shown as V_{TH} in many sources.

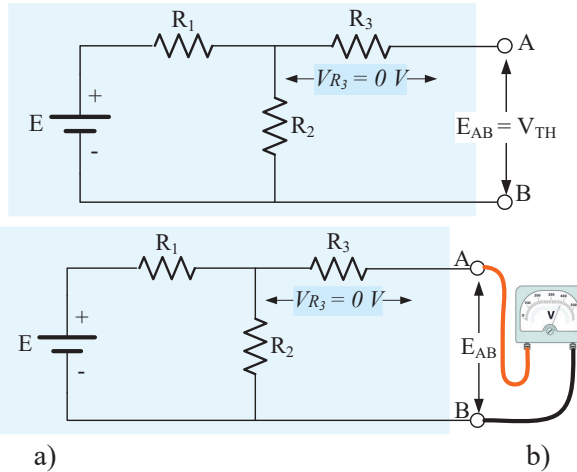

Figure-15 Finding E_{AB} a) Circuit Used in Theoretical Calculation b) Voltmeter Connection Required for Experimental Calculation

The E_{AB} voltage value becomes equal to the V_{R2} voltage falling to the ends of the R_2 resistor. Since A and B terminals are open circuit, no current will flow through the R_3 resistor, so there is no voltage drop on it. Accordingly, the E_{AB} voltage value;

$$V_{TH} = E_{AB} = V_{R2} = \left(\frac{E}{R_1 + R_2} \right) \cdot R_2$$

or

$$V_{TH} = E_{AB} = E - V_{R1} = E - \left(\frac{E}{R_1 + R_2} \right) \cdot R_1$$

found. The E_{AB} voltage value found by the theoretical calculation is the voltage value measured with the ideal Voltmeter connected between the A-B terminals given in Figure-15 b).

b) Finding the Thevenin equivalent resistance value (R_{AB})

Thevenin equivalent resistance value, also referred to as R_{TH} , can be calculated by disabling the sources in the circuit. For this, the voltage sources in the circuit are made short-circuited and the current sources are open-circuited. The R_{AB} value we will find by way of calculation is actually the equivalent resistance value that the ohmmeter connected between the A-B terminals will show. If the sources in the circuit have internal resistance, they should stay in place. The R_{AB} value found by the theoretical calculation method is the resistance value measured experimentally from the ohmmeter connected to the A-B terminals. As it is known, when measuring resistance in circuits, sources in the circuit are disabled. This rule is also used to find the Thevenin resistance.

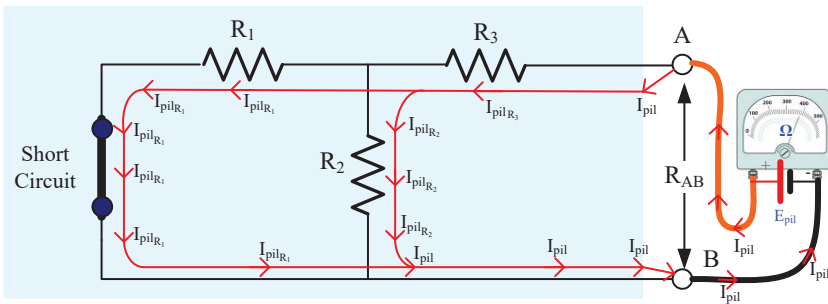

Figure-16

In the circuit given in Figure-16, it is the current supplied to the circuit by the battery in the I_{pil} ohmmeter and undertakes the task of generating emf. The currents and directions that occur in the resistors in the circuit while the R_{AB} is being found are shown in the figure. Accordingly, R_{AB} resistance value;

$$R_{AB} = R_{TH} = R_3 + (R_1 // R_2)$$

$$R_{AB} = R_{TH} = R_3 + \left(\frac{R_1 \cdot R_2}{(R_1 + R_2)} \right)$$

is found. Since the current that the measuring instrument gives to the circuit will also be equal to the R_3 current,

$$I_{pil} = \frac{E_{pil}}{R_{AB}} = I_{pilR_3}$$

is found. The currents passing through the resistors R_1 and R_2 are

$I_{pil_{R_1}} = I_{pil} \cdot \left(\frac{R_2}{(R_1 + R_2)} \right)$ $I_{pil_{R_2}} = I_{pil} \cdot \left(\frac{R_1}{(R_1 + R_2)} \right)$	or	$I_{pil_{R_1}} = I_{pil} - I_{pil_{R_2}}$ $I_{pil_{R_2}} = I_{pil} - I_{pil_{R_1}}$
---	----	---

can be said to be. After this analysis, it can be said that there is another way to find the resistance value of R_{AB} without resetting the sources in the circuit. Namely, I_{AB} current value is measured by connecting an ideal ammeter between the A-B ends of the circuit. According to this;

$$R_{AB} = R_{TH} = \frac{E_{AB}}{I_{AB}}$$

The R_{AB} value can be found.

c) Finding the Load Current (I_y)

After the Thevenin equivalent circuit is obtained, when the R_y resistor is connected to the A-B terminals, the load-connected Thevenin Equivalent Circuit given in Figure-17 a) is obtained.

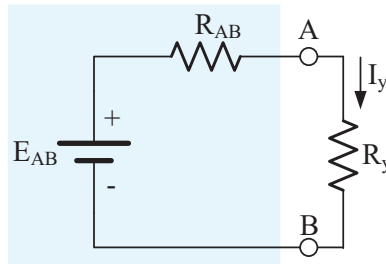

Figure-17 Load Connected Thevenin Equivalent Circuit
The current through resistor R_y here is,

$$I_y = \frac{E_{AB}}{R_{AB} + R_y}$$

is found.

Example 4: Calculate the current flowing through the resistor R_3 by applying Thevenin's Theorem to the circuit in Figure-18.

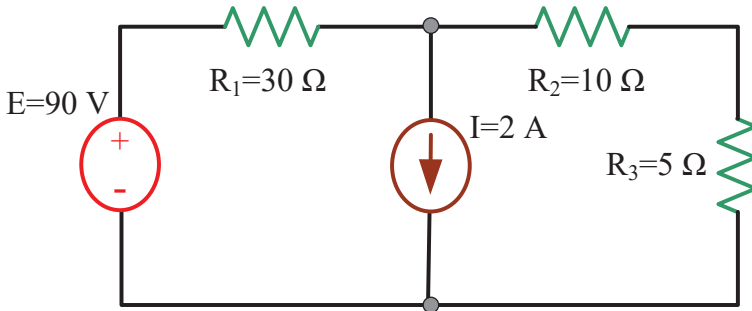
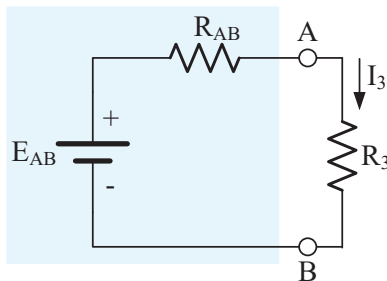
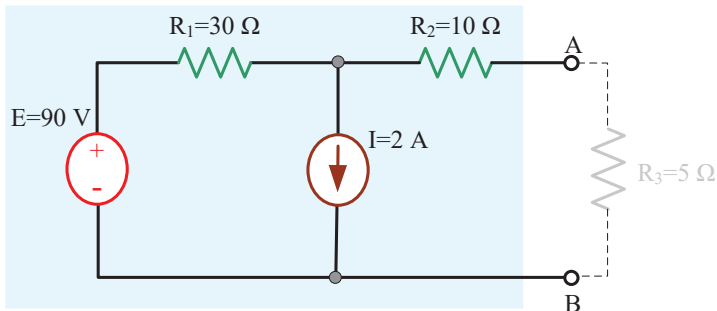

Figure-18

Solution: If the process steps are applied;

- 1 - The terminals connected to the resistor R_3 in the circuit are marked as A and B.
- 2 - With this marking, the R_3 resistor is deactivated as shown in Figure-17.
- 3- Equivalent of the circuit is calculated according to the A-B ends.
- 4- The removed R_3 resistor is connected to the ends of the Thevenin equivalent circuit to be calculated.



a)

b)

Figure-19 a) Removal of the R_3 resistor from the original circuit b) Thevenin Equivalent Circuit

a) Finding the Thevenin equivalent voltage value (E_{AB}): With the theoretical calculation, the value of the E_{AB} voltage source is the value that an ideal voltmeter connected to the A-B terminals of the circuit will show, as shown in Figure-20. Since the A-B ends of the circuit are open, no current flows through the resistor R_2 . Considering this point, V_{AB} voltage;

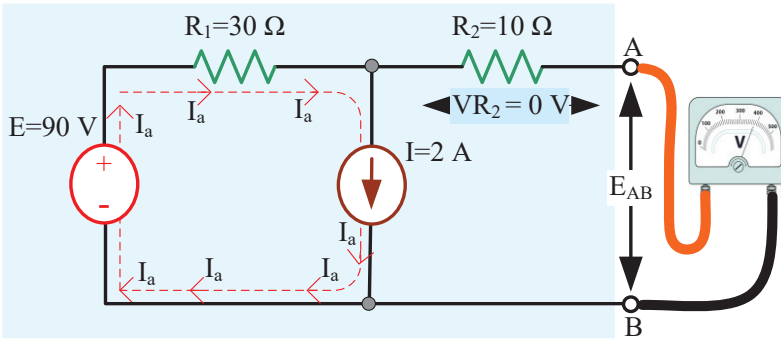

Figure-20

$$-E + VR_1 + E_{AB} = 0$$

$$E_{AB} = E - V \cdot R_1 = E - I_a \cdot R_1 = E - I \cdot R_1$$

$$E_{AB} = 90 - 2 \cdot 30 = 30 \text{ V}$$

is found.

b) Finding the Thevenin equivalent resistance value (R_{AB}): Voltage sources in the circuit are short circuited, and current sources are open circuited. The R_{AB} value we will find by way of calculation is actually the equivalent resistance value that the ohmmeter connected between the A-B terminals will show. When the current direction of the voltage source in the ohmmeter is followed, it is seen that the resistances of R_1 and R_2 are in series with each other as seen in Figure-21.

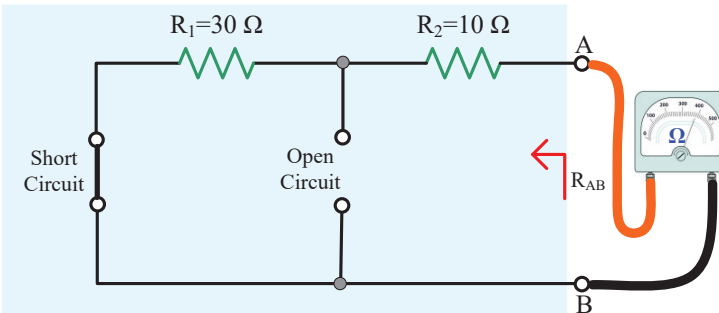

Figure-21

$$R_{AB} = R_{TH} = R_1 + R_2 = 30 + 10 = 40 \Omega$$

c) Finding Current I_3 : Thevenin equivalent circuit of the circuit is shown in the shaded part in Figure-22.

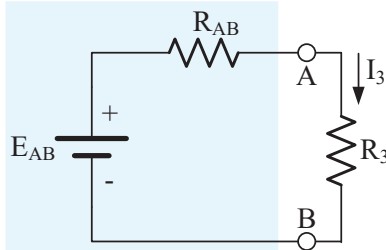

Figure-22 R_3 Connected Thevenin Equivalent Circuit

The I_3 current obtained when the R_3 resistor is connected to the Thevenin Equivalent Circuit,

$$I_3 = \frac{E_{AB}}{R_{AB} + R_3} = \frac{30}{40 + 5} = 0,66 \text{ A}$$

is found. The Matlab/Simulink simulation of the situation where the R_3 resistor is connected to the original circuit is shown in Figure-23 and the R_3 resistor connected to the Thevenin equivalent circuit is shown in Figure-24. It is seen that the currents through resistor R_3 are the same in both cases.

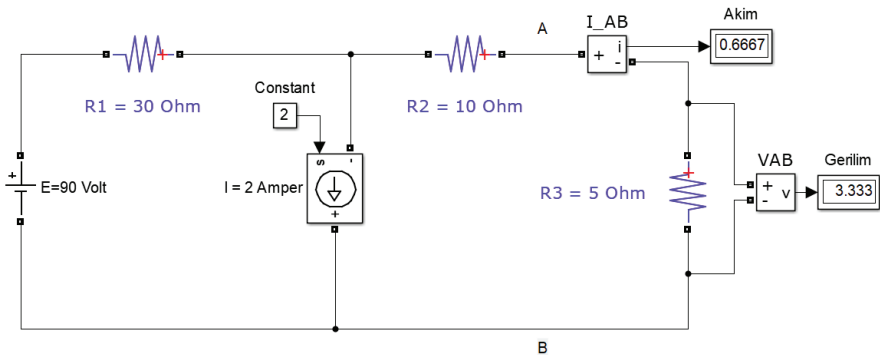

Figure-23 Load Connected Original Circuit

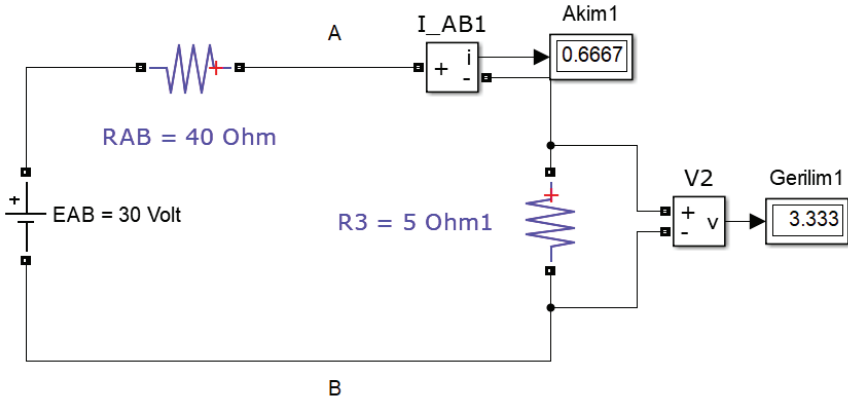

Figure-24 Load Connected Thevenin equivalent circuit

Example 5: Calculate the current flowing through the resistor R_2 by applying Thevenin's Theorem to the circuit in Figure-25.

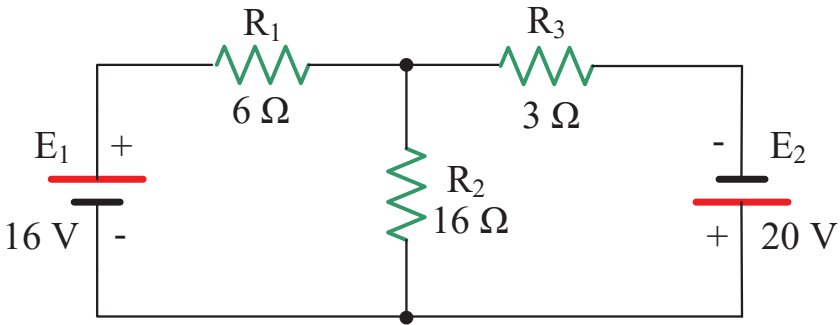

Figure-25

Solution: If the R_2 resistor is deactivated in the circuit in Figure-25 and in Figure-26, Thevenin equivalent circuit can be calculated by examining the circuit in the shaded area from A-B ends.

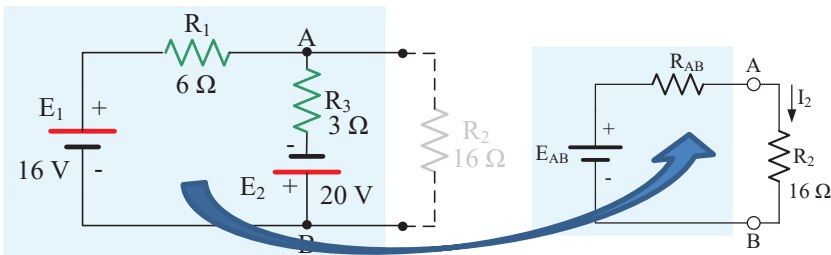

Figure-26

However, in order to find the Thevenin equivalent circuit, there is no need to show the original circuit in the shaded area, nor does it need to be redrawn in another way. The reason for using the shaded area so far is to facilitate the understanding of the subject. In the next circuits, the solution will be made without using the shaded area, as shown in Figure-27.

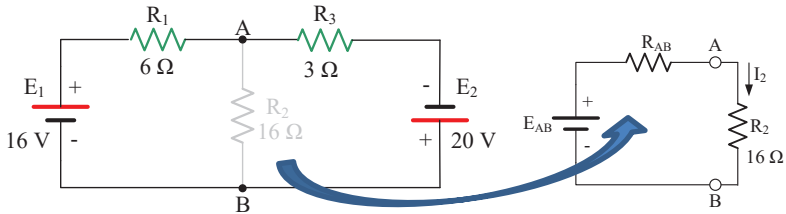

Figure-27

a) Calculation of E_{AB} Value: Thevenin voltage is calculated by connecting a Voltmeter as shown in Figure-28 instead of the R_2 resistor removed from the A-B ends of the original circuit given in Figure-25.

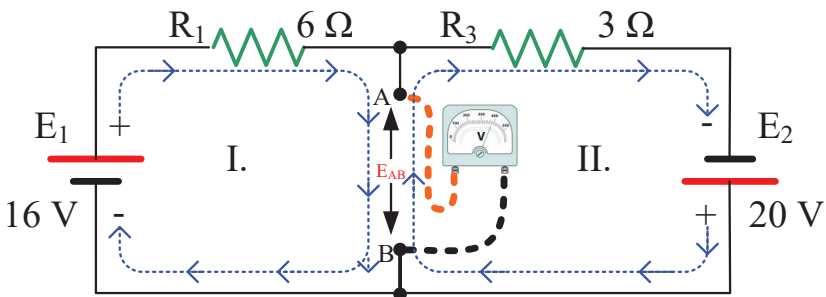

Figure-28.

Peripheral currents in the circuit shown in Figure-28 are equal to each other since the terminals A-B are open circuits.

I. Çevre Denklemi

$$-E_1 + VR_1 + E_{AB} = 0$$

$$E_{AB} = E_1 - I \cdot R_1 = 16 - I \cdot 6 (*)$$

II. Çevre Denklemi

$$-E_{AB} + VR_3 - E_2 = 0$$

$$E_{AB} = I \cdot R_3 - E_2 = I \cdot 3 - 20 (**)$$

If the two environmental equations (* and **) are solved together, the E_{AB} voltage is calculated.

$$16 - 6I = 3I - 20$$

$$9I = 16 + 20$$

$$I = 4 \text{ A}$$

is found. If the current I is substituted in the equation in one of the circles, the E_{AB} voltage is calculated.

$$E_{AB} = E_1 - I \cdot R_1 (*)$$

$$E_{AB} = 16 - 4 \cdot 6 = -8 \text{ V}$$

or

$$E_{AB} = E_2 - I \cdot R_3 (**)$$

$$E_{AB} = -20 - 4 \cdot 3 = -8 \text{ V}$$

is found.

b) Finding the Thevenin equivalent resistance value (R_{AB}): The voltage sources in the circuit are short-circuited. When the current direction provided by the voltage source in the ohmmeter is followed, it is seen that the resistances of R_1 and R_2 are parallel to each other as seen in Figure-29.

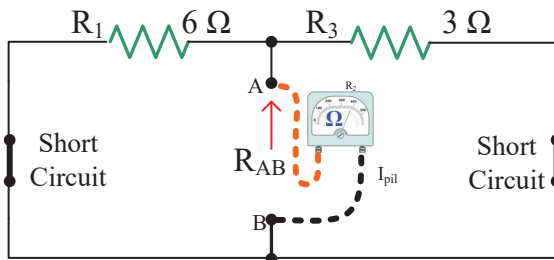
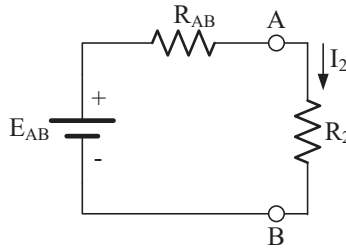

Figure-29.

$$R_{AB} = R_{TH} = \frac{R_1 \cdot R_2}{R_1 + R_2} = 2 \Omega$$

is found.

c) Finding Current I_3 : Thevenin equivalent circuit obtained after finding E_{AB} and R_{AB} in the circuit is shown in Figure-30.

Figure-30 Thevenin Equivalent Circuit Connected to R_3

The I_2 current obtained when the R_2 resistor is connected to the Thevenin Equivalent Circuit,

$$I_2 = \frac{E_{AB}}{R_{AB} + R_2} = \frac{-8}{2 + 16} = -0,444 \text{ A}$$

is found. The negative value of the current means that the current I_2 flows from B to A.

4. Norton's Theorem

Norton's theorem is a method for solving mixed electrical circuits with one or more sources and multiple circuits. The solution of Norton's theorem is similar to Thevenin's Theorem. In Thevenin's theorem, a voltage source and a series resistor are connected to form the Thevenin Equivalent Circuit, while in Norton's theorem, a current source and a resistor connected in parallel to it are created as a Norton Equivalent Circuit.

Norton's theorem is the transformation of an electrical circuit consisting of linear resistance and sources into a current source and a parallel resistance according to either end. This two-terminal circuit is called Norton Equivalent Circuit.

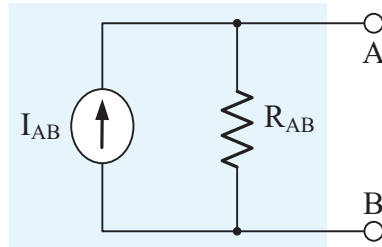

Figure-31. Norton Equivalent Circuit General Notation

The Norton equivalent circuit as shown is actually a real current source model. Here, I_{AB} represents the ideal current source value and R_{AB} represents the internal resistance of the current source. The value and direction of the current source and the value of the resistor depend on the elements in the original circuit.

4.1 Analysis of Electrical Circuits by Converting to Thevenin Equivalent Circuit

When a resistor R_y is connected to an electrical circuit as in Figure-32. a), if the current I_y passing through this resistor is found using Thevenin's Theorem,

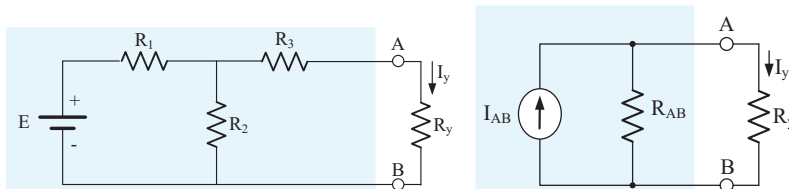

Figure-32. a) Original Circuit b) Norton Equivalent Circuit

Required steps to obtain Thevenin equivalent circuit

- The terminals connected to the resistor R_y in the circuit are marked A-B.
- The R_y resistor is disabled.
- Free A-B terminals are short-circuited.
- The current through this short circuit is the Norton equivalent circuit I_{AB} current.
- The I_{AB} current source is defined as the Short-circuit current between the two ends of the circuit.
- The circuit inside the shaded area has the Norton equivalent circuit.
- R_y load resistor is connected to terminals A-B of Norton equivalent circuit.

- Although the Norton equivalent circuit and the original circuit are not similar to each other, the current passing through the R_y resistor connected between the A-B terminals and the voltage falling on this resistor will both be the same. Accordingly, the circuits in the two shaded areas are equivalent to each other. Conversion of the Norton equivalent according to the A-B ends of the circuit elements except the R_y resistor in the circuit and finding the current I_y are given below.

a) Finding the I_{AB} Value: In order to calculate the value read from the ideal ammeter connected between the terminals A-B in the circuit in Figure-33, the following steps should be followed.

- A short circuit is made through the A-B ends of the circuit.
- I_{AB} short-circuit current passing through A-B terminals is calculated.
- This calculated current is the value of the I_{AB} current that the ideal ammeter connected between A-B terminals will show.
- I_{AB} current is also the current through resistor R_3 .

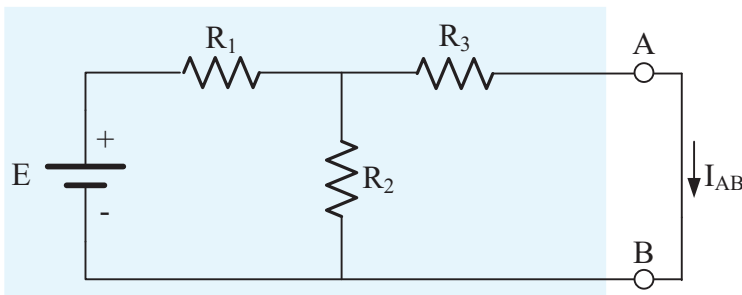

Figure-33

Accordingly, Norton current;

$$I_N = I_{AB} = I \cdot \left(\frac{R_2}{R_2 + R_3} \right)$$

is expressed as.

b) Finding the Resistance R_{AB} : The R_{AB} equivalent resistance value from the A-B ends of the circuit is calculated as in Thevenin's theorem. Voltage sources are disabled by making an Open Circuit, provided that they remain in place if they have internal resistances. The R_{AB} value calculated from the A-B ends of the circuit is actually the resistance value read from the ohmmeter connected to these ends.

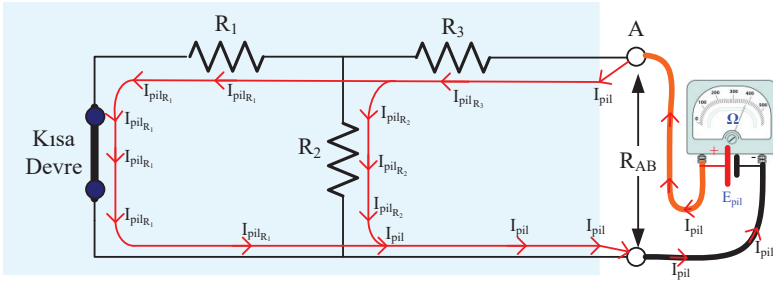

Figure-34 Finding the R_{AB} resistor

In the circuit given in Figure-34, I_{pil} is the current supplied to the circuit by the battery in the ohmmeter and undertaking the task of generating emf. The currents and directions that occur in the resistors in the circuit while the R_{AB} is being found are shown in the figure. Accordingly, the R_{AB} resistance value is;

$$R_{AB} = R_N = R_3 + (R_1 // R_2)$$

$$R_{AB} = R_N = R_3 + \left(\frac{R_1 \cdot R_2}{(R_1 + R_2)} \right)$$

is found.

c) Finding the load current (I_y): When the R_y resistor is connected to the A-B ends of the Norton equivalent circuit, a simple circuit seen in Figure-35 is obtained.

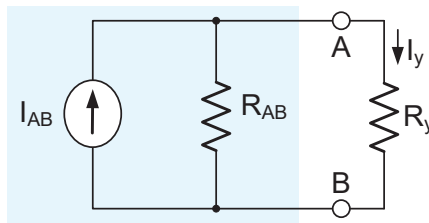

Figure-35 Connecting the Load to the Norton Equivalent Circuit

current through resistor R_y ;

$$I_y = I_{AB} \left(\frac{R_{AB}}{R_{AB} + R_y} \right)$$

is found with the expression.

The main difference of Norton's theorem from Thevenin's theorem is that it uses a current source instead of a voltage source. Norton's and Thevenin's theorems can be obtained directly or by conversion to each other. Since the direction of the current source in Norton equivalent determines the polarity of the voltage source in Thevenin equivalent in interconversions, attention should be paid to the current and voltage directions.

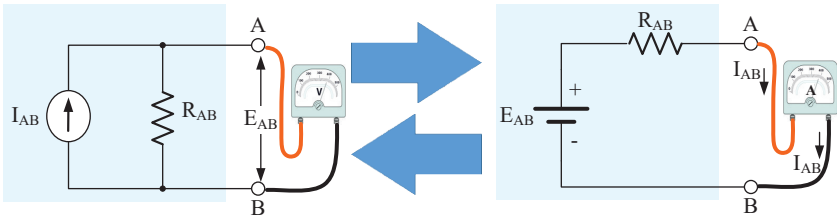

Figure-36 Conversion of Norton and Thevenin Equivalent Circuits

Example 6: Calculate the current flowing through the resistor R_2 by applying Norton's Theorem to the circuit in Figure-37.

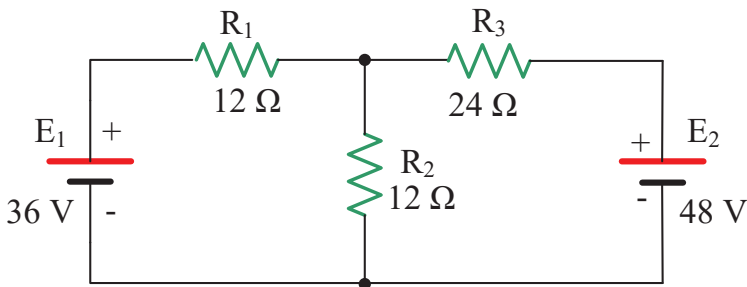

Figure-37

Solution: If the R_2 resistance is taken out of the circuit and redrawn in the circuit in the figure, if it is redrawn in Figure-38, the Norton equivalent circuit can be calculated by examining the circuit in the shaded area from the ends a-b.

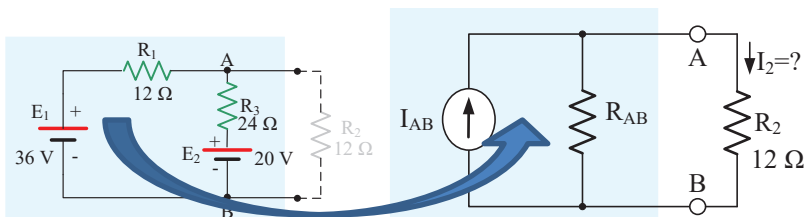

Figure-38

However, in order to find the Norton equivalent circuit, there is no need to show the original circuit in the shaded area, nor does it need to be redrawn in another way. The reason for using the shaded area so far is to facilitate the understanding of the subject. In the next circuits, the solution will be made without using the shaded area as shown in Figure-39.

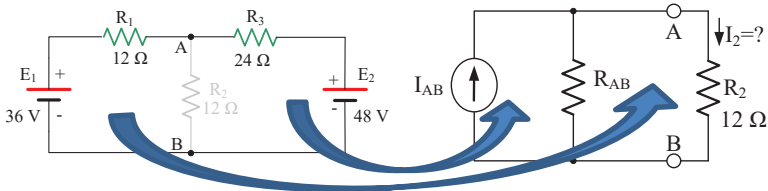

Figure-39

a) Calculation of I_{AB} Value: In Figure-37, A-B ends of the original circuit are short-circuited. The I_{AB} current is calculated. Norton current is calculated by connecting the Ammeter as shown in Figure-40 instead of the disconnected R_2 resistor.

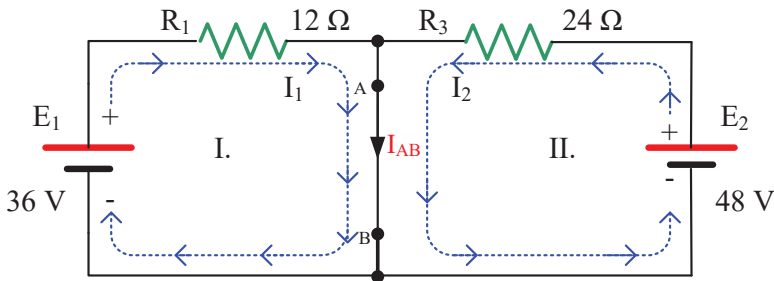

Figure-40

The currents passing through the circles shown in the circuit in Figure-40 are equal to each other since the ends A-B are open circuits.

Equation I

$$-E_1 + VR_1 = 0$$

$$0 = -36 + I_1 \cdot R_1 = -36 + 12 \cdot I_1 (*)$$

$$I_1 = 3 A$$

Equation II

$$-VR_3 + E_2 = 0$$

$$0 = 48 - I_2 \cdot R_3 = 48 - 24 \cdot I_2 (**)$$

$$I_2 = 2 A$$

For I_1 and I_2 currents, I_{AB} current is found if KCL (Kirchhoff Current Law) is applied to node A.

$$I_{AB} = I_1 + I_2 = 3 + 2 = 5 A$$

b) Finding the Norton equivalent resistance value (R_{AB}): The voltage sources in the circuit are short-circuited. When the current direction provided by the voltage source in the ohmmeter is followed, it is seen that the resistances of R_1 and R_3 are parallel to each other as seen in Figure-41.

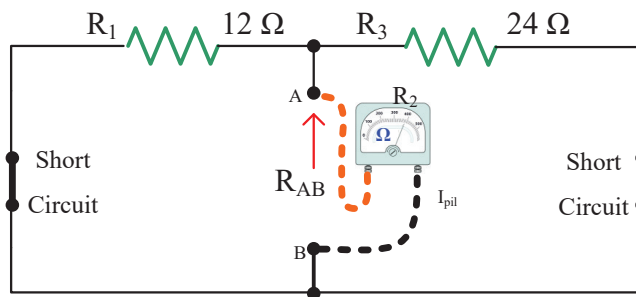

Figure-41

$$R_{AB} = R_N = \frac{R_1 \cdot R_3}{R_1 + R_3} = \frac{12 \cdot 24}{12 + 24} = 8 \Omega$$

is found.

c) Finding Current I_2 : The Norton equivalent circuit obtained after finding the I_{AB} and R_{AB} in the circuit is shown in Figure-42.

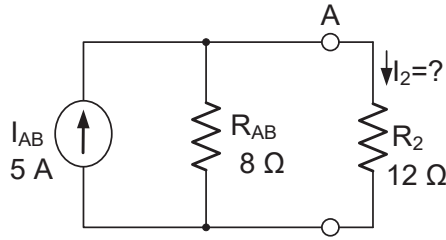

Figure-42 R_2 Connected Norton Equivalent Circuit

The I_2 current obtained when the R_2 resistor is connected to the Thevenin Equivalent Circuit,

$$I_2 = I_{AB} \frac{R_{AB}}{R_{AB} + R_2} = 5 \frac{8}{8 + 12} = 2 \text{ A}$$

is found. The negative value of the current means that the current I_2 flows from B to A.

Note: Since the I_{AB} and R_{AB} values in the Norton equivalent circuit are known, the Thevenin equivalent circuit can be obtained by transforming the current source into a voltage source as shown in Figure-43.

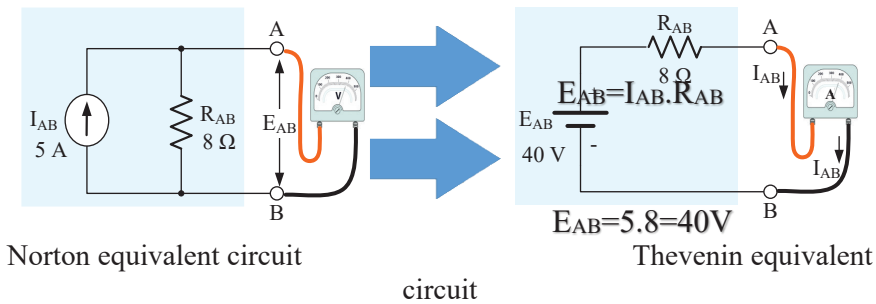

Figure-43 Conversion of Norton and Thevenin Equivalent Circuits

5. Maximum Power Transfer Theorem

The Maximum Power Transfer Theorem explains the conditions under which the maximum power that a load connected to a real voltage or current source can draw from the source depends on. It is very important to calculate the maximum value of the power that a system can give to the load. These systems to be calculated, such as photovoltaic [18-21] source or power electronics based switch selection [22], have an important place in the circuit design of various power converters [23-27].

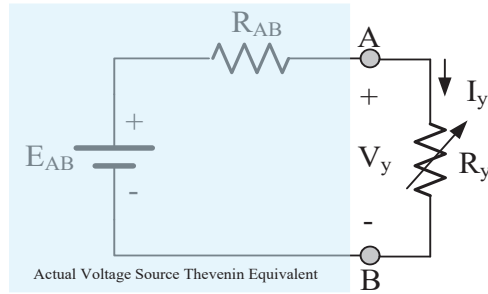

Figure-44

If an analysis is made to examine the condition for obtaining maximum power from the R_y load resistor connected to the ends of a real voltage source Thevenin equivalent circuit as in Figure-44; $R_y = R_{AB}$ must be equal. If this condition is met, the power drawn from the source, in other words, the power consumed in R_y will be at its maximum value. To prove this, I_y load current in the circuit in Figure-44,

$$I_y = \frac{E_{AB}}{R_{AB} + R_y}$$

The power drawn by the R_y charge from the source;

$$P_y = I_y^2 R_y = \left(\frac{E_{AB}}{R_{AB} + R_y} \right)^2 R_y = \frac{E_{AB}^2}{(R_{AB} + R_y)^2} R_y$$

It can be formulated as If the variation (derivative) of the power with respect to the load resistance is zero, the power is maximum.

$$\frac{\partial P_y}{\partial R_y} = 0$$

$$\frac{\partial P_y}{\partial R_y} = \frac{\partial}{\partial R_y} P_y = \frac{\partial}{\partial R_y} \left(\frac{E_{AB}^2}{(R_{AB} + R_y)^2} R_y \right) = 0$$

When the derivative of the expression is taken;

$$\frac{E_{AB}^2 (R_{AB} + R_y)^2 - 2E_{AB}^2 R_y (R_{AB} + R_y)}{(R_{AB} + R_y)^4} = 0$$

$$\frac{E_{AB}^2 (R_{AB} + R_y)^2 - 2E_{AB}^2 R_y (R_{AB} + R_y)}{(R_{AB} + R_y)^{4-3}} = 0$$

$$\frac{(R_{AB} + R_y) - 2R_y}{\frac{(R_{AB} + R_y)^3}{E_{AB}^2}} = 0$$

$$(R_{AB} + R_y) - 2R_y = 0 \Rightarrow R_{AB} = R_y$$

found. Thus, when the load resistance is equal to the Thevenin equivalent resistance, the derivative expression is zero. Therefore, the maximum power draw of the R_y load from the source depends on the condition $R_y = R_{AB}$.

The obtained result can be interpreted as follows:

1. In the Thevenin equivalent circuit, that is, a circuit consisting of an independent voltage source and a resistor in series with it can transfer maximum power to the load resistor, provided that the load resistance R_y value is equal to the series resistance value.
2. In the Norton equivalent circuit, that is, a circuit consisting of an independent current source and a resistor connected in parallel to it can transfer maximum power to the load resistor, provided that the load resistance R_y value is equal to the parallel resistance value.
3. Under maximum power conditions, half of the E_{AB} voltage value falls on the internal resistance of the source, ie R_{AB} , and the other half on the R_y load, in a circuit as in Figure 44. In this case, the welding efficiency is 50%.

Example 7: Find the values that R_y will take so that the load resistor R_y connected to the A-B terminals in the circuit in Figure-45 can draw maximum power from the source. Calculate the current flowing through the R_y resistor you found, applying Thevenin's theorem, the maximum power drawn from the source, and the efficiency of the circuit.

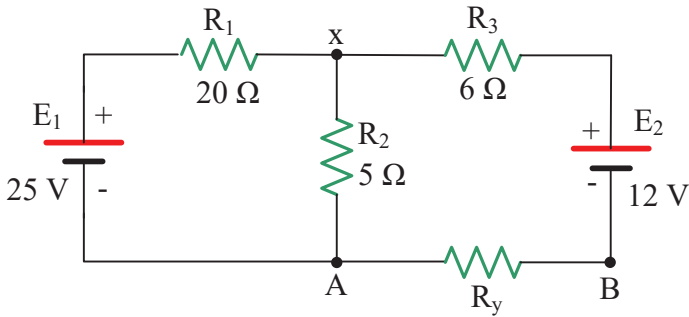

Figure-45

Solution: In the circuit in the figure, the Thevenin equivalent is as follows when viewed from the A-B ends.

a) Calculation of E_{AB} Value:

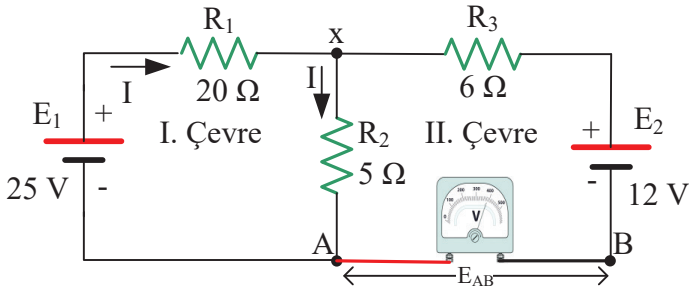

Figure-46

Eq-I.

$$-E_1 + VR_1 + VR_2 = 0$$

$$-E_1 + IR_1 + IR_2 = 0$$

$$-25 + I \cdot 20 + I \cdot 5 = 0$$

$$I = 1A$$

Eq-I.

$$-VR_2 - VR_3 + E_2 - E_{AB} = 0$$

$$-IR_2 - 0 - 12 - E_{AB} = 0$$

$$E_{AB} = 12 - 5 = 7V$$

b) Finding the Thevenin equivalent resistance value (R_{AB}): The voltage sources in the circuit are short-circuited. When the current direction provided by the voltage source in the ohmmeter is followed, it is seen that the resistances of R_1 and R_2 are parallel to each other as seen in Figure-47.

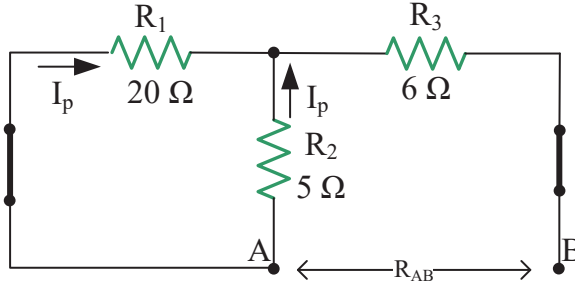

Şekil-47

$$R_{AB} = R_{AB} = [(R_1 // R_2) + R_3] = 20 + 10 = 18 \Omega$$

c) Finding Current I_3 : Thevenin equivalent circuit obtained after finding E_{AB} and R_{AB} in the circuit is shown in Figure-48.

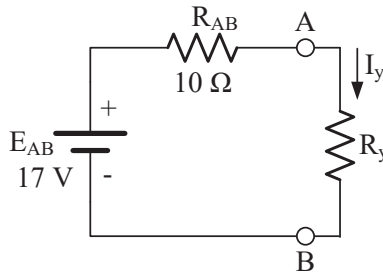
Figure-48 R_3 Connected Thevenin Equivalent Circuit

$R_y = R_{AB} = 10 \Omega$ so that the load R_y can draw maximum power from the source.

Circuit current;

$$I_y = \frac{E_{AB}}{R_{AB} + R_y} = \frac{17}{10 + 10} = 0,35 \text{ A}$$

Voltage equation at the load ends;

$$VR_y = I_y R_y = 0,35 \cdot 10 = 3,5 \text{ V}$$

The maximum power the load draws from the source;

$$P_y = I_y^2 R_y = VR_y \cdot I_y = 3,5 \cdot 0,35 = 1,225 \text{ W}$$

The power that the source gives to the circuit;

$$P_{\text{kaynak}} = E_{AB} \cdot I_y = 7 \cdot 0,35 = 2,45 \text{ W}$$

The efficiency of the circuit;

$$\eta = \frac{P_y}{P_{\text{kaynak}}} 100 = \frac{1,225}{2,45} 100 = \%50$$

found.

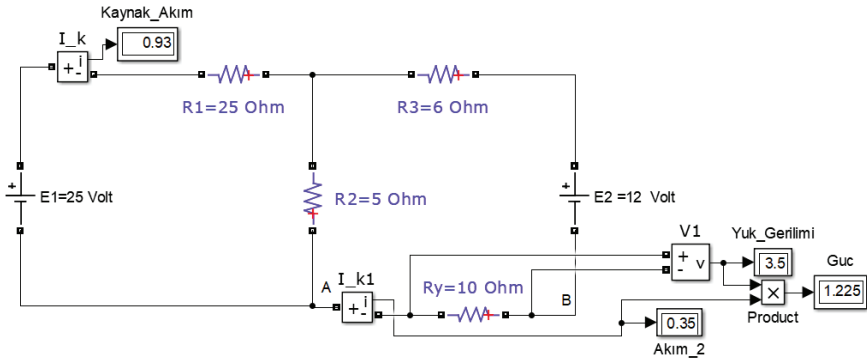

Şekil-49

The simulation of the circuit in Matlab / Simulink environment is shown in Figure-49.

REFERENCES

- [1] Charles, K. A., & Matthew, N. O. (2017). *Fundamentals of electric circuits*.
- [2] McGraw-hill Education. Boylestad, R. L. (2013). *Introductory circuit analysis*. Pearson Education.
- [3] Irwin, J. D., & Nelms, R. M. (2020). *Basic engineering circuit analysis*. John Wiley & Sons.
- [4] Nahvi, M., & Edminister, J. A. (2018). *Schaum's outline of Electric Circuits*. McGraw-Hill Education.
- [5] Nilsson, J. W., & Riedel, S. A. (2020). *Electric circuits*. Pearson.
- [6] Tokad, Y. (1981). *Devre analizi dersleri: kısım I*. Uludağ Üniversitesi.
- [7] Tokad, Y. (1987). *Devre analizi dersleri: kısım-II*. Çağlayan kitabevi.
- [8] Salam, M. A., & Rahman, Q. M. (2018). *Fundamentals of electrical circuit analysis* (pp. 1-463). New York: Springer.
- [9] Güller, İ. (2010). *Doğru Akım Devre Analizi ve Çözümlü Örnekler*. İstanbul: Birsen Yayınevi.
- [10] Zenk, H., & Akpınar, A. S. (2013, May). PI, PID and fuzzy logic controlled SSSC connected to a power transmission line, voltage control performance comparison. In *4th International Conference on Power Engineering, Energy and Electrical Drives* (pp. 1493-1497). IEEE.
- [11] Zenk, H., & Akpınar, A. S. (2012). Multi zone power systems load-frequency stability using fuzzy logic controllers. *Journal of Electrical and Control Engineering*, 2, 49-54.
- [12] Zenk, H., Şenol H. & Güner, F. (2019). Lunar Excursion Module Landing Control System Design with P, PI and PID Controllers. *Karadeniz Fen Bilimleri Dergisi*, 9(2), 390-405.
- [13] Zenk, H. (2019). Effective Control of the Developmental Current of a Serial DC Motor with a Fuzzy Tuned-PI Controller Zeta Converter. *Karadeniz Fen Bilimleri Dergisi*, 9(1), 196-211.
- [14] Özbey, Ş. (2016). *Elektrik devre analizi-I*. Seçkin.

- [15] Zenk, O., & Ertuğral, B. (2021). *Electric Vehicle Battery Charging System Design with Dual Flyback Type Converter*. International Journal of Engineering and Information Systems, 5(12), pp.12-20.
- [16] Zenk, H., & Güner, F. (2021). *Innovation Process of Electric Vehicles*. Research & Reviews in Engineering – I. Publisher: Gece Kitaplığı / Gece Publishing
- [17] Zenk, H., & Ertuğral, B. (2018). Comparison of the Electrical Performance of NiCd, NiMH and Li-Ion Batteries by Simulation. In *International Conference on Agriculture, Technology, Engineering and Sciences (ICATES 2018)* (Vol. 1, No. 1, pp. 352-363).
- [18] Zenk, H.(2020). *Comparison of Voltage Stability of Photovoltaic Power Source Dual Structure Flyback Converter with Fuzzy-Tuned PI and Fractional PID Type Controllers*. Karadeniz Fen Bilimleri Dergisi, 10(2), 443-465.
- [19] Zenk, H. (2019). *Comparison of the performance of photovoltaic power generation-consumption system with push-pull converter under the effect of five different types of controllers*. International Journal of Photoenergy, 2019.
- [20] Zenk, H. (2018). Low Cost Provides of the Energy Needs of Plateau Houses by Using Photovoltaic Systems. *Turkish Journal of Agriculture-Food Science and Technology*, 6(12), 1768-1774.
- [21] Zenk, H., & Akpınar, A. S. (2013). Solar Power Generation Potentials of The Houses in Turkey. In *International Conference on Environmental Science and Technology (ICOEST 2013)*.
- [22] Zenk, H. (2018). Comparison of Electrical Performances of Power Electronics Switches and an Effective Switch Selection Algorithm. *Acta Physica Polonica A*, 133(4), 897-901.
- [23] Zenk, H. (2019). Effective Control of the Developmental Current of a Serial DC Motor with a Fuzzy Tuned-PI Controller Zeta Converter. *Karadeniz Fen Bilimleri Dergisi*, 9(1), 196-211.
- [24] Zenk, H. (2016). In push-pull converter output voltage stability comparison with using fuzzy logic, PI and PID controllers. *International Journal of Engineering Research and Management*, 3(12), 1-6.
- [25] Zenk, H. (2020). Comparison of Voltage Stability of Photovoltaic Power Source Dual Structure Flyback Converter with Fuzzy-Tuned PI and Fractional PID Type Controllers. *Karadeniz Fen Bilimleri Dergisi*, 10(2), 443-465.

- [26] Zenk, O., & Ertuğral, B. (2022). Electric Vehicle Application of Fuzzy Logic Controlled Z Connected DC Converter Topology. *International Journal of Engineering and Information Systems (IJEAIS)*, 6(11), pp.31-40.
- [27] Zenk, H., & Akpınar, A. S. (2014). Dynamic Performance Comparison of Cúk Converter with DC Motor Driving and Using PI, PID, Fuzzy Logic Types Controllers. *Universal Journal of Electrical and Electronic Engineering*, 2(2), 90-96.

“

Chapter 19

ANALYSIS OF UNIFORM FRAMES UNDER HORIZONTAL LOADS

Duygu OZTURK¹

Kanat Burak BOZDOĞAN²

”

1 Asst. Prof., Ege University, ORCID: 0000-0001-7800-7438

2 Prof. Dr., Canakkale Onsekiz Mart University, ORCID: 0000-0001-7528-2418

1. INTRODUCTION

Frame systems are the most common type of bearing systems used in low and medium-rise buildings, and they show a good performance in earthquakes when they are built in accordance with regulations and standards. Calculation of the story displacements of the frames under lateral loads and the maximum drift ratios are extremely important in terms of determining their vulnerability in earthquakes. Approximate methods are needed to determine the storey displacements and the maximum interstorey drift ratios, especially in the pre-sizing stage. One of these methods is the Continuum Method. There are a number of studies in the literature on the Continuum Method. Murashev et al. (1968) proposed a practical approach for the static and dynamic analysis of multi-storey uniform buildings in their book [1]. Heidebrecht and Smith (1973) proposed an approximate method for the static analysis of tall buildings using the Continuum Method [2]. Bilyap (1979) introduced and developed the method in Turkey [3]. Ertutar (1995) proposed a relation for the static analysis of frames under lateral loads [4]. Miranda (1999) proposed an approach for the static analysis of buildings under different lateral loads [5]. Zalka (2000) proposed a method for the analysis of multi-storey buildings in his study called Global Analysis [6]. Tekeli et al. (2013) proposed a similar analytical method for the static analysis of frames [7]. Zalka (2019) developed the methods in his previous book [8].

2. CALCULATION of DISPLACEMENTS and DRIFT RATIOS of MULTI-STOREY FRAMES UNDER UNIFORM LATERAL LOADS

Figure 1 shows a frame system under a uniform horizontal load. As can be seen, the multi-storey multi-span frame system can be represented as an equivalent Timoshenko beam. In Figure 1, K_s is the equivalent shear stiffness and D is the global bending stiffness representing axial displacements.

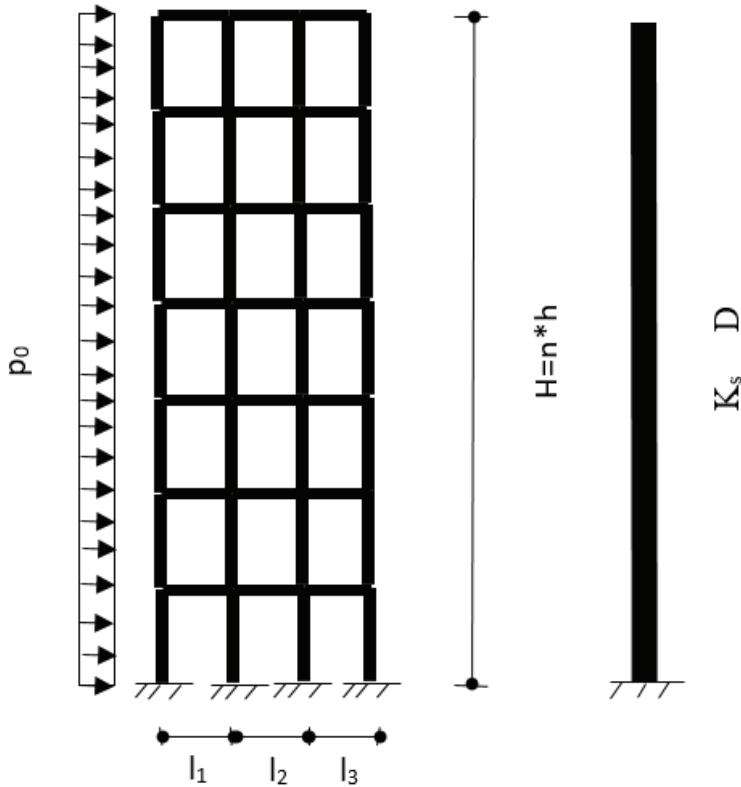

Figure 1 Equivalent model for frame

Assuming that the moment zero points in columns and beams of the floors are in the middle of columns and beams, the value of K_s can be calculated by the Equation (1) [1,2].

$$K_{si} = \frac{12}{h(\frac{1}{s} + \frac{1}{r})} \quad i = 2,3 \dots n \tag{1}$$

On the first floor, the moment zero point in the columns is at a distance of $\frac{2}{3} h$ from the floor. In this case, the K_s value for this floor can be calculated by the Equation (2) [9].

$$K_{s1} = \frac{8}{h_1(\frac{1}{s_1} + \frac{1}{5r_1})} \tag{2}$$

In Equation (1) and Equation (2), h is the story height, s is the ratio of the sum of the bending stiffness of the columns at that floor to the height of the floors, and r is the sum of the ratios of the bending stiffness to the span of the beams at that floor.

The shear stiffness can be taken as the average of the calculated shear stiffness for each floor.

Global bending stiffness is calculated by Equation (3).

$$D = E \sum_j^I A_j (x_j - \bar{x})^2 \quad (3)$$

Here E is the Modulus of Elasticity, A_j is the area of the column j , $x_j - \bar{x}$ shows the distance of the column j . from the center of gravity of all columns. Total story displacement is the sum of the displacements of shear and bending. This expression is shown in equation (4).

$$y = y_s + y_b \quad (4)$$

Here y_s is the shear displacement and y_b is the bending displacement.

The Equation (4) valid for displacements can also be written as in Equation (5) for drift ratio.

$$\frac{dy}{dx} = \frac{dy_s}{dx} + \frac{dy_b}{dx} \quad (5)$$

Equation (6) can be written for shear displacements under uniform load [4]

$$K_s \frac{d^2 y_s}{dx^2} = -p_0 \quad (6)$$

To make the Equation (6) dimensionless, if the transformation in Equation (7) is applied, the dimensionless differential Equation (8) is obtained.

$$\varepsilon = \frac{x}{H} \quad (7)$$

$$\frac{d^2 y_s}{d\varepsilon^2} = -\frac{p_0 H^2}{K_s} \quad (8)$$

The boundary conditions of the differential Equation (8), displacement at the base and the shear force at the top is zero, are shown by Equation (9) and Equation (10).

$$y_s(0) = 0 \quad (9)$$

$$\text{for } \varepsilon = 1 \quad \frac{K_s}{H} \frac{dy_s}{d\varepsilon} = 0 \quad (10)$$

The Equation (11) is obtained by solving the differential Equation (8) with the boundary conditions in Equation (9) and Equation (10).

$$y_s(\varepsilon) = \frac{p_0 H^2}{2K_s} [2\varepsilon - \varepsilon^2] \quad (11)$$

By using the Equation (11), the drift ratio value is found as follows.

$$\frac{dy_s}{d\varepsilon} = \frac{p_0 H^2}{K_s} [1 - \varepsilon] \quad (12)$$

Equation (13) is written to find the displacement caused by the axial forces in the frame under uniform load. [1,4,7]

$$D \frac{d^4 y_b}{dx^4} = p_0 \quad (13)$$

If the transformation in Equation (7) is applied in Equation (13), Equation (14) is obtained.

$$\frac{d^4 y_b}{d\varepsilon^4} = \frac{p_0 H^4}{D} \quad (14)$$

The boundary conditions of the differential Equation (14) are zero displacement and rotation at the base, and zero bending moment and shear force at the top. These conditions are shown by Equations (15), (16), (17) and (18).

$$y_b(0) = 0 \quad (15)$$

$$\text{for } \varepsilon = 0 \quad \frac{1}{H} \frac{dy_b}{d\varepsilon} = 0 \quad (16)$$

$$\text{for } \varepsilon = 1 \quad \frac{D}{H^2} \frac{d^2 y_b}{dx^2} = 0 \quad (17)$$

$$\text{for } \varepsilon = 1 \quad \frac{D}{H^3} \frac{d^3 y_b}{dx^3} = 0 \quad (18)$$

With the solution of the differential Equation (14) with given boundary conditions, the storey displacements are found by Equation (19).

$$y_b(\varepsilon) = \frac{p_0 H^4}{D} \left[\frac{\varepsilon^4}{24} - \frac{\varepsilon^3}{6} + \frac{\varepsilon^2}{4} \right] \quad (19)$$

By using the Equation (19), the Equation (20) and Equation (21) are obtained for the drift ratio and its derivative.

$$\frac{1}{H} \frac{dy_b}{d\varepsilon} = \frac{1}{H} \frac{p_0 H^4}{D} \left[\frac{\varepsilon^3}{6} - \frac{\varepsilon^2}{2} + \frac{\varepsilon}{2} \right] \quad (20)$$

$$\frac{d^2 y_b}{d\varepsilon^2} = \frac{p_0 H^4}{D} \left[\frac{\varepsilon^2}{2} - \varepsilon + \frac{1}{2} \right] \quad (21)$$

The dimensionless coefficient a is defined as the behavior coefficient for the frame system as follows.

$$a = \frac{1}{H} \sqrt{\frac{D}{K_s}} \quad (22)$$

The total story displacement is found as the sum of the displacements caused by shear and bending, as follows.

$$y = y_s + y_b = \frac{p_0 H^2}{2K_s} [2\varepsilon - \varepsilon^2] + \frac{p_0 H^4}{D} \left[\frac{\varepsilon^4}{24} - \frac{\varepsilon^3}{6} + \frac{\varepsilon^2}{4} \right] \quad (23)$$

By making use of the Equation (22), the Equation (23) can be written as follows.

$$y = \frac{p_0 H^4}{D} \left[a^2 \varepsilon - \frac{a^2 \varepsilon^2}{2} + \frac{\varepsilon^4}{24} - \frac{\varepsilon^3}{6} + \frac{\varepsilon^2}{4} \right] \quad (24)$$

By writing $\varepsilon=1$ at the top, the maximum displacement is found as follows.

$$y = \frac{p_0 H^4}{D} \left[a^2 - \frac{a^2}{2} + \frac{1}{24} - \frac{1}{6} + \frac{1}{4} \right] = k_1 \frac{p_0 H^4}{D} \quad (25)$$

In order to find the location of the maximum value, the derivative of the drift ratio is set to zero, and Equation (26) and Equation (27) are obtained.

$$\frac{d^2 y}{d\varepsilon^2} = \frac{d^2 y_s}{d\varepsilon^2} + \frac{d^2 y_b}{dx^2} = -\frac{p_0 H^2}{K_s} + \frac{p_0 H^4}{D} \left[\frac{\varepsilon^2}{2} - \varepsilon + \frac{1}{2} \right] = 0 \quad (26)$$

$$\frac{d^2 y}{d\varepsilon^2} = \frac{p_0 H^4}{D} \left[-a^2 + \frac{\varepsilon^2}{2} - \varepsilon + \frac{1}{2} \right] \quad (27)$$

For total drift ratio, the Equation (28) is written.

$$\frac{1}{H} \frac{dy}{d\varepsilon} = \frac{1}{H} \frac{dy_s}{d\varepsilon} + \frac{1}{H} \frac{dy_b}{d\varepsilon} = \frac{1}{H} \frac{p_0 H^2}{K_s} [1 - \varepsilon] + \frac{1}{H} \frac{p_0 H^4}{D} \left[\frac{\varepsilon^3}{6} - \frac{\varepsilon^2}{2} + \frac{\varepsilon}{2} \right] \quad (28)$$

By using the Equation (22) the Equation (28) is written as follows.

$$\frac{dy}{d\varepsilon} \frac{1}{H} = \frac{1}{H} \frac{p_0 H^4}{D} \left[a^2 - a^2 \varepsilon + \frac{\varepsilon^3}{6} - \frac{\varepsilon^2}{2} + \frac{\varepsilon}{2} \right] \quad (29)$$

In Equation (27) where ε is zero, the drift ratio becomes maximum. In this case, if this ε value is substituted in Equation (29), Equation (30) is obtained.

$$\frac{dy}{d\varepsilon} \frac{1}{H} = \frac{k_2 p_0 H^4}{H D} \quad (30)$$

For different values of a , coefficients of k_1 and k_2 are calculated using the Equation (25) and Equation (30) and are given in Table 1 and Table 2.

Table 1 The coefficient k_1 depending on the dimensionless parameter for uniform load

a	k_1
0	0.125
0.1	0.13
0.2	0.145
0.3	0.17
0.4	0.2050000
0.5	0.25
0.6	0.3050000
0.7	0.3700000
0.8	0.4450000
0.9	0.53
1	0.625
2	2.125
3	4.625
4	8.125
5	12.625
6	18.125
7	24.625
8	32.125
9	40.625
10	50.125
11	60.625
12	72.125
13	84.625
14	98.125
15	112.625

16	128.125
17	144.625
18	162.125
19	180.625
20	200.125
25	312.625
30	450.125

Table 2 The maximum drift ratio location and coefficient k_2 depending on the dimensionless parameter for uniform load

a	location	k_2
0	1	0.167
0.1	0.859	0.168
0.2	0.717	0.174
0.3	0.576	0.1921
0.4	0.434	0.2270
0.5	0.293	0.2845
0.6	0.152	0.3703
0.7	0.0101	0.49
>0.7	0	a^2

3. CALCULATION of DISPLACEMENTS and DRIFT RATIOS of MULTI-STOREY FRAMES UNDER TRIANGULAR LATERAL LOADS

The differential equation showing the shear displacements under triangular load is written as follows.

$$K_s \frac{d^2 y_s}{dx^2} = -\frac{p_0 x}{H} \quad (31)$$

In order to make the differential Equation (31) dimensionless, if the transformation in Equation (7) is applied, the differential Equation (32) is obtained.

$$\frac{d^2 y_s}{d\varepsilon^2} = -\frac{p_0 H^2}{K_s} \varepsilon \quad (32)$$

If the differential Equation (32) is solved with the boundary conditions in (9) and (10), the Equation (33) is obtained for the storey displacements function

$$y_s(\varepsilon) = \frac{p_0 H^2}{6K_s} [3\varepsilon - \varepsilon^3] \quad (33)$$

By using the Equation (33) the drift ratio value is found as follows.

$$\frac{1}{H} \frac{dy_s}{d\varepsilon} = \frac{1}{H} \frac{p_0 H^2}{2K_s} [1 - \varepsilon^2] \quad (34)$$

For the displacements caused by axial forces under the triangular load, the differential Equation (35) is written.

$$D \frac{d^4 y_b}{dx^4} = \frac{p_0 x}{H} \quad (35)$$

If the transformation in (7) is applied in Equation (35), differential Equation (36) is obtained.

$$\frac{d^4 y_b}{d\varepsilon^4} = \frac{p_0 H^4}{D} \varepsilon \quad (36)$$

In the differential Equation (36), if the boundary conditions given in (15), (16), (17) and (18) are applied, the Equation (37) is obtained for the story displacement

$$y_b(\varepsilon) = \frac{p_0 H^4}{D} \left[\frac{\varepsilon^5}{120} - \frac{\varepsilon^3}{12} + \frac{\varepsilon^2}{6} \right] \quad (37)$$

By using the Equation (37), the Equation (38) and Equation (39) are obtained for the drift ratio and its derivative.

$$\frac{1}{H} \frac{dy_b}{d\varepsilon} = \frac{1}{H} \frac{p_0 H^4}{D} \left[\frac{\varepsilon^4}{24} - \frac{\varepsilon^2}{4} + \frac{\varepsilon}{3} \right] \quad (38)$$

$$\frac{d^2 y_b}{d\varepsilon^2} = \frac{p_0 H^4}{D} \left[\frac{\varepsilon^3}{6} - \frac{\varepsilon}{2} + \frac{1}{3} \right] \quad (39)$$

In the case of a triangular load, the following equation can be written for the total story displacement.

$$y = y_s + y_b = \frac{p_0 H^2}{6K_s} [3\varepsilon - \varepsilon^3] + \frac{p_0 H^4}{D} \left[\frac{\varepsilon^5}{120} - \frac{\varepsilon^3}{12} + \frac{\varepsilon^2}{6} \right] \quad (40)$$

Using the Equation (22), the Equation (41) is written as follows.

$$y = \frac{p_0 H^4}{D} \left[a^2 \frac{\varepsilon}{2} - a^2 \frac{\varepsilon^3}{6} + \frac{\varepsilon^5}{120} - \frac{\varepsilon^3}{12} + \frac{\varepsilon^2}{6} \right] \quad (41)$$

By writing $\varepsilon=1$ at the top, the maximum displacement is found as follows.

$$y_{max} = \frac{p_0 H^4}{D} \left[a^2 \frac{1}{2} - a^2 \frac{1}{6} + \frac{1}{120} - \frac{1}{12} + \frac{1}{6} \right] = k_3 \frac{p_0 H^4}{D} \quad (42)$$

In order to find the location of the maximum value, the derivative of the drift ratio is set to zero and the Equation (43) is obtained.

$$\frac{d^2 y}{d\varepsilon^2} = \frac{d^2 y_s}{d\varepsilon^2} + \frac{d^2 y_b}{dx^2} = -\frac{p_0 H^2}{K_s} \varepsilon + \frac{p_0 H^4}{D} \left[\frac{\varepsilon^3}{6} - \frac{\varepsilon}{2} + \frac{1}{3} \right] = 0 \quad (43)$$

By using the Equation (22) the Equation (43) can be written as follows.

$$\frac{d^2 y}{d\varepsilon^2} = \frac{p_0 H^4}{D} \left[-a^2 \varepsilon + \frac{\varepsilon^3}{6} - \frac{\varepsilon}{2} + \frac{1}{3} \right] \quad (44)$$

For the total drift ratio, Equation (45) is written.

$$\frac{1}{H} \frac{dy}{d\varepsilon} = \frac{1}{H} \frac{dy_s}{d\varepsilon} + \frac{1}{H} \frac{dy_b}{d\varepsilon} = \frac{1}{H} \frac{p_0 H^2}{2K_s} [1 - \varepsilon^2] + \frac{1}{H} \frac{p_0 H^4}{D} \left[\frac{\varepsilon^4}{24} - \frac{\varepsilon^2}{4} + \frac{\varepsilon}{3} \right] \quad (45)$$

In Equation (45), where ε is zero the drift ratio becomes maximum. In this case, Equation 46 is written.

$$\frac{1}{H} \frac{dy}{d\varepsilon} = \frac{k_4 p_0 H^4}{H D} \quad (46)$$

For different values of a , coefficients of k_3 and k_4 are calculated using the Equation (42) and Equation (46) and are given in Table 3 and Table 4.

Table 3 The coefficient k_3 depending on the dimensionless parameter for the triangular load

a	k_3
0	0.0916667
0.1	0.095
0.2	0.105
0.3	0.1216667
0.4	0.1450000
0.5	0.175
0.6	0.2116667
0.7	0.255
0.8	0.3050000

0.9	0.3616667
1	0.425
2	1.4250000
3	3.0916667
4	5.425
5	8.425
6	12.0916667
7	16.4250000
8	21.4250000
9	27.0916667
10	33.4250000
11	40.4250000
12	48.0916667
13	56.4250000
14	65.425
15	75.0916667
16	85.425
17	96.425
18	108.09167
19	120.425
20	133.425
25	208.425
30	300.092

Table 4 The maximum drift ratio location and coefficient k_4 depending on the dimensionless parameter for the triangular load

a	location	k_4
0	1	0.125
0.1	0.865	0.1258627
0.2	0.745	0.1313121
0.3	0.639	0.1444922
0.4	0.546	0.1673248
0.5	0.467	0.2008651
0.6	0.4	0.2456
0.7	0.344	0.3016738
0.8	0.296	0.3690454
0.9	0.257	0.4475863
1	0.223	0.5371396
2	0.074	1.9625461
3	0.035	4.4986569
4	0.0202	8.0015605

5	0.0131	12.501531
6	0.0091	18.001235
7	0.0067	24.500984
8	0.0052	32.000786
9	0.00409	40.500631
10	0.0033	50.000523
11	0.0027	60.500438
12	0.0023	72.000373
13	0.0020	84.500318
14	0.0017	98.000274
15	0.0015	112.50024
16	0.0013	128.00021
17	0.0012	144.50019
18	0.0010	162.00017
19	0.00092	180.50015
20	0.00083	200.00014
25	0.00053	312.50006
30	0.00037	450.00005

4. NUMERICAL EXAMPLE

In the 7-storey plane frame given in Figure 2, the columns are 30 cm/60 cm and the beams are 25 cm/50 cm. The modulus of elasticity is $E=3 \cdot 10^7$ kN/m². The story displacements and maximum drift ratio of the given plane frame are calculated with the Continuum Method for the two cases given below, and the results are compared with the SAP2000 program..

- a) For $p=40$ kN/m uniform load
- b) For the case of $p=80$ kN/m triangular load

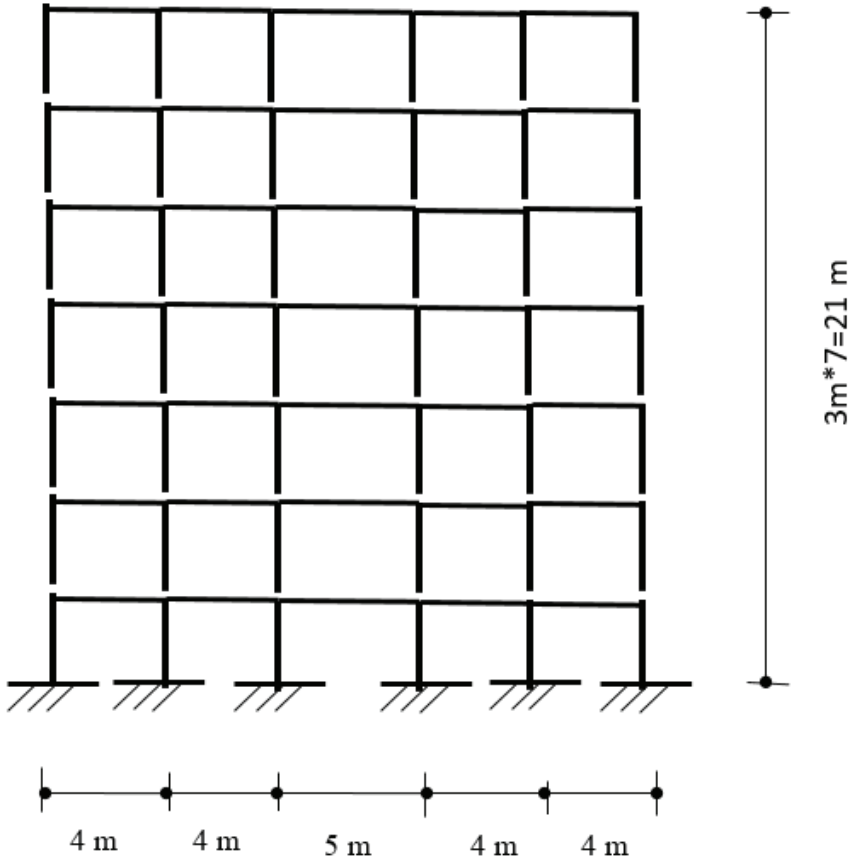

Figure 2 Seven story frame

SOLUTION

For the solution, firstly equivalent stiffness and dimensionless a values are calculated. Calculated values are given in Table 5.

Table 5 Equivalent stiffness and dimensionless a values

Story	K_s (kN)	D (kNm ²)	a
1	472275.6691	1714500000	-
2-7	251787.380	1714500000	-
	283285.707	1714500000	3.705

After the dimensionless value was found, k_1 and k_2 values are read from Table 1 and Table 2 for uniform load, and k_3 and k_4 values for triangular load. Then, storey displacements and maximum drift ratios are calculated by the Equation (24), Equation (30), Equation (41) and Equation (46). They are given in Table 6, Table 7, Table 8 and Table 9.

Table 6 Storey displacements for uniform load

Story	Method (m)	SAP 2000 (m)
1	0.0083	0.0046
2	0.0153	0.0113
3	0.0211	0.0172
4	0.0257	0.0221
5	0.0289	0.0256
6	0.0310	0.278
7	0.0317	0.288

Table 7 Maximum drift ratio for uniform load

Method	SAP2000
0.002966	0.00223

Table 8 Storey displacements for triangular load

Story	Method (m)	SAP 2000 (m)
1	0.0089	0.0051
2	0.0174	0.0133
3	0.0253	0.0216
4	0.0321	0.0292
5	0.0374	0.0354
6	0.0410	0.0400
7	0.0423	0.0429

Table 9 Maximum drift ratio for triangular load

Method	SAP2000
0.002894	0.002733

KAYNAKLAR

- [1] Murashev, V.I Baikov, V.N, & Sigalov, E.E. (1968). Design of *Reinforced Concrete Structures*". Mir Publishers.
- [2] Heidebrecht, A. C., & Smith, B. S. (1973). Approximate analysis of tall wall-frame structures. *Journal of the Structural Division*, 99(2), 199–221. <https://doi.org/10.1061/jsdeag.0003440>
- [3] Bilyap, S. (1979). *Betonarme Yüksek Yapılarda Perde Çerçeve Sistemlerinin Yatay Kuvvetlere Göre Hesabı*". Ege Üniversitesi Matbaası. İzmir.
- [4] Ertutar, Y. (1995). Betonarme yüksek yapılarda yatay yük etkisi". *Dokuz Eylül Üniversitesi Yayınları*.
- [5] Miranda, E. (1999). Approximate seismic lateral deformation demands in multistory buildings. *Journal of Structural Engineering (New York, N.Y.)*, 125(4), 417–425. [https://doi.org/10.1061/\(asce\)0733-9445\(1999\)125:4\(417\)](https://doi.org/10.1061/(asce)0733-9445(1999)125:4(417))
- [6] Tekeli, H., Demir, F., & Atımtay, E. (2013). ÇERÇEVELİ VE PERDELİ-ÇERÇEVELİ BETONARME BİNALARIN ÖTELENMESİ: ANALİTİK ÇÖZÜMLER. *Gazi Üniversitesi Mühendislik-Mimarlık Fakültesi Dergisi*, 23(1), 0-. Retrieved from <https://dergipark.org.tr/tr/pub/gazimmfd/issue/6675/88275>
- [7] Zalka, K. (2000). *Global Structural Analysis of Buildings*. CRC Press.
- [8] Zalka, K. (2020). *Structural analysis of multi-storey buildings*. CRC Press
- [9] Taranath, B. S. (2016). *Tall Building Design*. CRC Press.

“

Chapter 20

**ASSEMBLING OF COMPATIBILITY
CONDITION MATRIX VIA NULL
SPACE AND SINGULAR VALUE
DECOMPOSITION IN INTEGRATED
FORCE METHOD TO ANALYZE SPACE
TRUSS**

Hamit ÖZTÜRK^{1,2}

”

1 Dr.; Istanbul University – Cerrahpaşa, Department of Civil Engineering.
dr.ozturkhamit@gmail.com ORCID No: 0000-0002-9870-4430

2 Eastern Mediterranean University, Department of Civil Engineering

INTRODUCTION

It is essential for a building to be stable and in balance while it is being built. If not, the built edifice will collapse. According to Newton's Law, internal forces should equal the total of external forces plus imported loads to achieve this goal. Therefore, the equilibrium equation of the structure should be put together in order to design the structure and assess the member section, supports conditions, and other building qualities (S. N. Patnaik, D. A. Hapkins, and G. R. Halford, 2004), (West, 1993).

When the number of equations and the number of unknowns in a determinate structure are equal, merely the production of an equilibrium equation (EE) and a simple solution will be sufficient to calculate the structure's unknown forces. For indeterminate cases, however, it is not possible to solve the unknowns using simply the generation of the EE and requires the use of an additional equation set in order to retrieve the unknowns (S. N. Patnaik, D. A. Hapkins, and G. R. Halford, 2004), (SAOUMA, 1999).

The EE was written by Navier in an attempt to compute the reactions of a 4-legged table, although there were three equations and four unknowns in total. Navier then discovered that the structure is not determinate, and he was unable to find a solution. The primary consideration in solving this issue was the requirement for an additional equation to square the Navier's (3x4) rectangular equation matrix. Patnaik and his research team named this extra equation "compatibility condition (1x4) matrix" (S. N. Patnaik, D. A. Hapkins, and G. R. Halford, 2004), (E. Soyer, and A. Topcu, 2001).

The Integrated Force Method (IFM) was constructed by fusing the Navier's (3 x 4) rectangular EE matrix with the Patnaik's (1 x 4) compatibility condition (CC) matrix. After creating the EE matrix in this method (IFM), two algebraic techniques have been utilized to find the compatibility condition: 1) Null space method and 2) Singular Value Decomposition method.

Generally, utilization of IFM consists of following steps (Kassimali, 2011), (N. R. B. Krishnam Raju, and J. Nagabhushanam, 2000), (Patnaik, 1999) ;

- 1-Equilibrium equations (EE) should be assembled
- 2-Matrix of Compatibility condition (CC) should be created
- 3-Generated EE and CC matrix should be multiplied together to obtain [S] matrix
- 4-Internal forces are calculated by using [S] matrix

Writing EE and computing unknowns for large-scale structures and buildings will be highly difficult and time-consuming. As a result, using computer programs to solve the difficulties is inevitable. Space trusses are the structures under investigation in this project. The Force Method is used

to automatically generate the EE, which are then utilized to determine any unknown member forces.

METHODOLOGY

One type of construction that is frequently examined using equilibrium is the space truss. At least four members make up this form of construction (a space truss), and all of the joints are pins that are incapable of transmitting moments. In most cases, the stability of a space truss is achieved by joining four-face pieces.

Several presumptions are meant in order to assess the space truss in this study:

- Frictionless pin joints are used to attach the parts together.
- Only the nodes of the space truss were subject to all of the stresses and responses.
- The connecting line between each member's end nodes and its central axis are both parallel and straight.
- In truss, concentrated loads are encountered (not distributed load).

A space truss' nodes are made up of intersecting forces at which three moment equations are automatically met. As a result, each node only has to have three distinct force equilibrium equations. The condition that is necessary but insufficient to be determinative is expressed as follows:

$$b + r = 3j \quad (1)$$

Where, b, r and j are number of members, support's reactions and nodes, respectively.

If $b + r < 3j$, structure is unstable,

If $b + r = 3j$, structure is determinate and

If $b + r > 3j$, structure is indeterminate.

Creation of Equilibrium Equation(EE)

Three EE must be created for each node of the space truss, as was previously discussed. Six equilibrium equations are created to examine a space truss member with two nodes. A segment of the space truss depicted in Fig. 1 is utilized to demonstrate how the EE is put together, and member i-j is detached from the structure as indicated in Fig. 2.

Figure 1 shows that node i, is a support indicator where reaction R_i has been broken down into its three elements. The structure's node j serves as a joint indicator to show how the load P_j has been resolved to its parts. Asymmetrical force F_{ij} is thought to be a tension force that acts as a member force on nodes i and j. The forces are all pointing in the positive direction.

The separated member i-j and its terminal nodes' coordinates in the global coordinate system are shown in Figure 2. In the direction of X, Y,

and Z , respectively, the force F_{ij} is resolved to its parameters X_{ij} , Y_{ij} , and Z_{ij} at the end member i . The parameters are written as:

$$\begin{aligned} X_{ij} &= F_{ij} \left(\frac{X_j - X_i}{L_{ij}} \right) = F_{ij} l_{ij} \\ Y_{ij} &= F_{ij} \left(\frac{Y_j - Y_i}{L_{ij}} \right) = F_{ij} m_{ij} \\ Z_{ij} &= F_{ij} \left(\frac{Z_j - Z_i}{L_{ij}} \right) = F_{ij} n_{ij} \end{aligned} \quad (2)$$

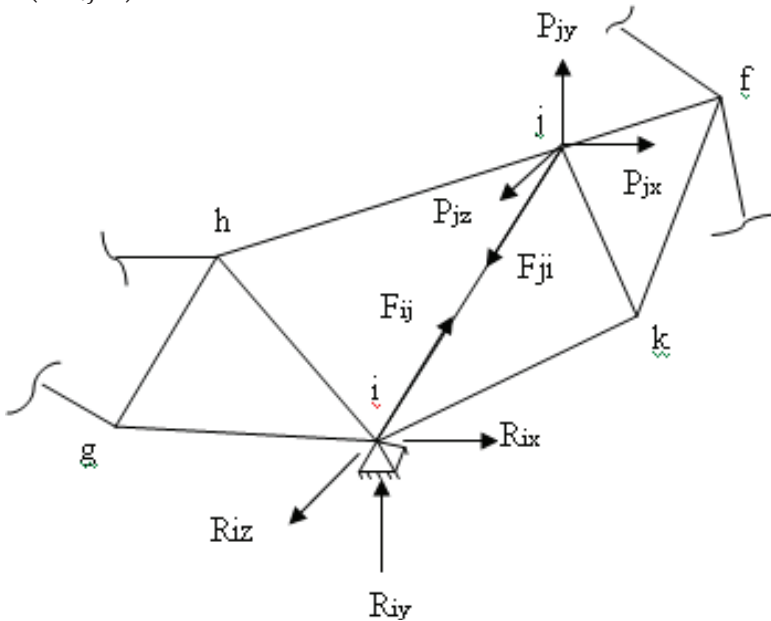

Figure 1. Separated member of Space Truss

In this terminology, the variables l_{ij} , m_{ij} , and n_{ij} are the direction cosines, which, respectively, denote the angles between the members i - j and the axes x , y , and z . Also, at the j node, the force F_{ji} is resolved to its elements in shown way;

$$\begin{aligned} X_{ji} &= F_{ji} \left(\frac{X_i - X_j}{L_{ij}} \right) = F_{ji} l_{ji} \\ Y_{ji} &= F_{ji} \left(\frac{Y_i - Y_j}{L_{ij}} \right) = F_{ji} m_{ji} \\ Z_{ji} &= F_{ji} \left(\frac{Z_i - Z_j}{L_{ij}} \right) = F_{ji} n_{ji} \end{aligned} \quad (3)$$

Where, l_{ji} , m_{ji} and n_{ji} are the cosines of member. Attention to the Eq. 2 and 3, it is observed that:

$l_{ji} = -l_{ij}$, $m_{ji} = -m_{ij}$ and $n_{ji} = -n_{ij}$. Since structure members are under tension then $f_{ij} = f_{ji}$. The length of member L_{ij} is obtained by formulation below:

$$L_{ij} = \sqrt{((X_j - X_i)^2 + (Y_j - Y_i)^2 + (Z_j - Z_i)^2)} \tag{4}$$

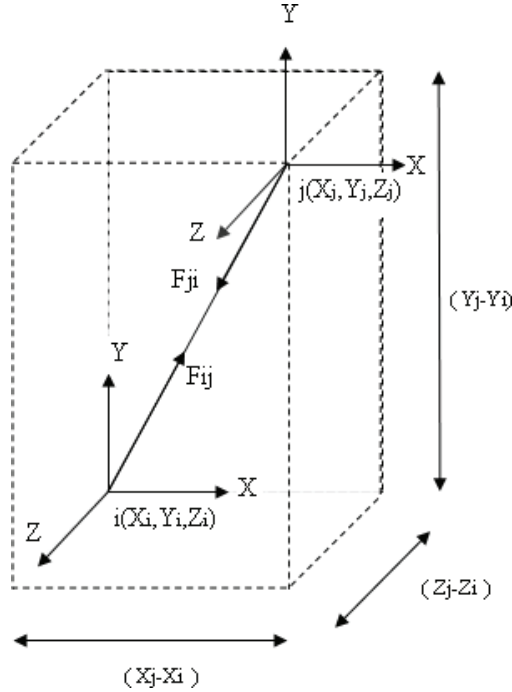

Figure 2. Member i-j of Truss

Now, according to truss structure in Fig.1, for member i-j EE can be written as follows:

$$\begin{aligned} X_{ig} + X_{ih} + X_{ij} + X_{ik} + R_{ix} &= 0 \\ Y_{ig} + Y_{ih} + Y_{ij} + Y_{ik} + R_{iy} &= 0 \\ Z_{ig} + Z_{ih} + Z_{ij} + Z_{ik} + R_{iz} &= 0 \\ X_{jh} + X_{ji} + X_{jk} + X_{jf} + P_{jx} &= 0 \\ Y_{jh} + Y_{ji} + Y_{jk} + Y_{jf} + P_{jy} &= 0 \\ Z_{jh} + Z_{ji} + Z_{jk} + Z_{jf} + P_{jz} &= 0 \end{aligned} \tag{5}$$

According to Eq.2-5, a general formulation for a space truss with n nodes can be generated as shown in Fig.3 and abbreviated as Eq.6.

$$[S] \begin{Bmatrix} \{F\} \\ \{R\} \end{Bmatrix} = \{P\} \tag{6}$$

In which, [S] is direction cosine matrix, {F} is forces vector of members, {R} is support reaction vector and {P} is load vector (exposed external loads).

deformations. Now, $[S]$ matrix is square and can be solved linearly. In the cases of not existing initial deformation, zero should be replaced in ΔR .

If displacements are required in the integrated force technique, where the main unknowns are the member forces, they can be computed by:

$$\{X\} = [J][G][F] \quad (9)$$

Where $\{X\}$ is nodal displacements and $[J]$ is transpose matrix of inversed $[S]$;

$$J = [[S]^{-1}]^T \quad (10)$$

In this study, to assemble compatibility condition two methods are used; 1) null space, 2) singular value decomposition.

Null space method[ns]:

To obtain CC in this method Eq.11 is used (S. N. Patnaik and K. T. Joseph, 1986).

$$[ns][G] = [C] \quad (11)$$

For this research, Mathematica software was used and finding null property of a matrix is built-in command in this software. Then, writing the command of 'nullspace[A]' is enough.

Singular value decomposition method:

To calculate CC in this method Eq.12 is used (S. N. Patnaik and K. T. Joseph, 1986), (Patnaik, 1999).

$$[M] = [I - [A]^T([A]^T)^{pinv}] \quad (12)$$

In which, Identity matrix $[I]$ has the same number of members as its columns and rows, $[A]^T$ is transpose of $[A]$ and $([A]^T)^{pinv}$ is the Moore-Penrose pseudo inverse of $[A]^T$ which is calculated by Eq.13.

$$([A]^T)^{pinv} = ([A][A]^T)^{-1}[A] \quad (13)$$

Obtained value for $[M]$ from Eq.12 is applied in Eq.13 and by usage of Eq. 15 – 17 CC will be calculated (Patnaik, 1999), (S. N. Patnaik and K. T. Joseph, 1986).

$$[M] = [M_u][M_\delta][M_v]^T \quad (14)$$

$[M_u]$ and $[M_v]$ are orthogonal matrix and number of rows and columns are equal to number of truss members.

$$[M_\delta] = \begin{pmatrix} 1 & 0 \\ 0 & 0 \end{pmatrix} \quad (15)$$

$$[M] = [M_u] \begin{bmatrix} [ns] \\ [0] \end{bmatrix} \quad (16)$$

$$[C] = [ns][G] \quad (17)$$

By coupling [A] with [C] and [G], matrix of [S] gets square and Eq.8 is used to obtain member forces.

COMPUTER PROGRAMMING CODES BY USING OF MATHEMATICA SOFTWARE

IFM by using of null space

In the integrated force technique, the CC is determined by using of the EE's null space property. The EE and CC that were found are then coupled together to produce the square matrix [S]. The unknowns are finally calculated using Eq.8 and this square matrix. Fig.4 illustrates the integrated force approach via null space.

IFM by using of singular value decomposition

Utilizing the singular value decomposition described in previous section is an additional technique for determining the CC in the IFM. Equation 12 is used to derive the EE and produce matrix $([A]^T)^{pinv}$. Equation 13 is then used to calculate matrix [M]. The matrix [M] is then subjected to singular value decomposition (SVD) to produce the matrices $[M_u]$, $[M_v]$, and $[M_\delta]$. Equations 15 and 16 can then be used to calculate the CC. Fig.5 depicts this integrated force technique procedure.

Data input phase

A simple illustration example is used in this section to introduce the programs: the indeterminate space truss shown in Fig.6. This section also provides examples of how to use these tools and how to enter structural data. The coordinates of the nodes and member connectivity for the space truss seen in Figure 6 are presented in Tables 1 and 2 respectively.

Table 1. Nodal data for space truss illustrated at Fig.6

Node Number	Coordinates			Applied Loads (kN)			Restraints		
	x	y	z	x	y	z	x	y	z
1	0	0	0	0	0	0	Fixed	Fixed	Fixed
2	0	3.5	0	0	0	0	Free	Free	Fixed
3	1	2	4	0	100	0	Free	Free	Free
4	5	3.5	0	0	0	0	Fixed	Fixed	Fixed

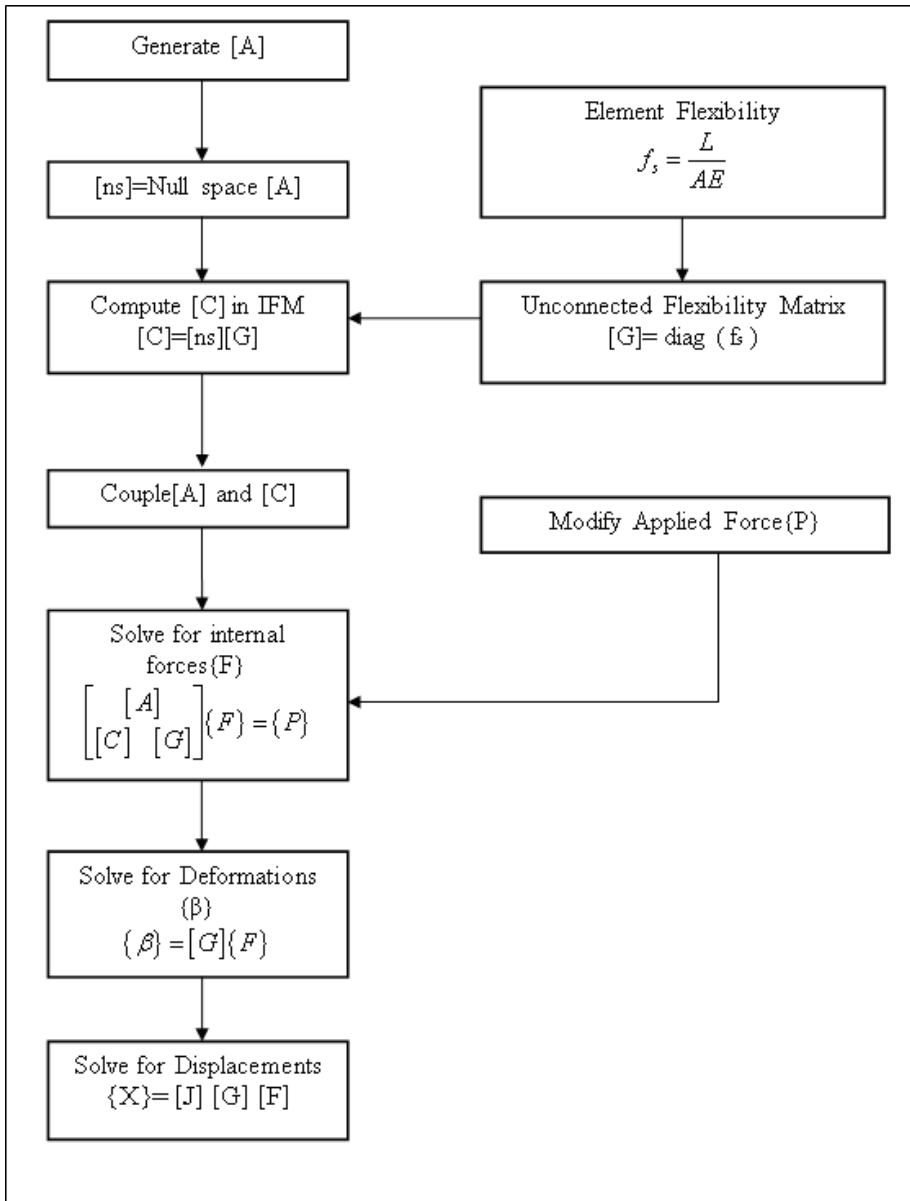

Figure 4. Algorithm of IFM via null space

Each member has an area of 0.0025 m² and an elastic modulus of $E=2 \cdot 10^8$ kN/m². Truss is subjected to just one external load, which enters at node 3.

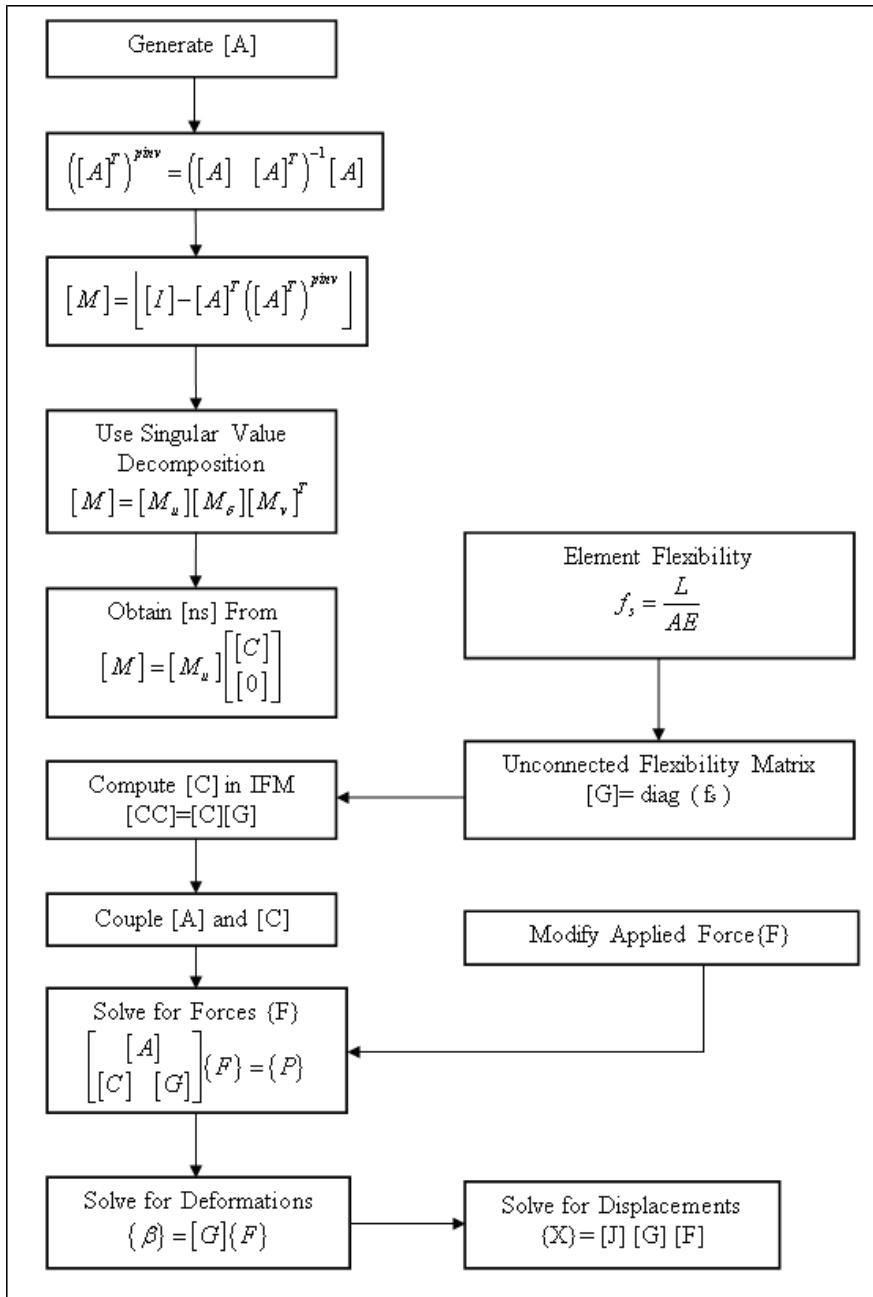

Figure 5. Algorithm for IFM via singular value decomposition

Nodes data input

The user must enter the nodes' number and coordinates in this section, which are depicted in Figure 7. The matrix dimension is $n \cdot 4$. Each

node's number is displayed in this matrix's first column. Coordinates for X, Y, and Z are displayed in the second, third, and fourth columns of this matrix.

Table 2. Elemental data of truss of Fig.6

Element Number	Connectivity	
	Start Node	End Node
1	1	2
2	2	3
3	1	3
4	3	4
5	2	3
6	1	4

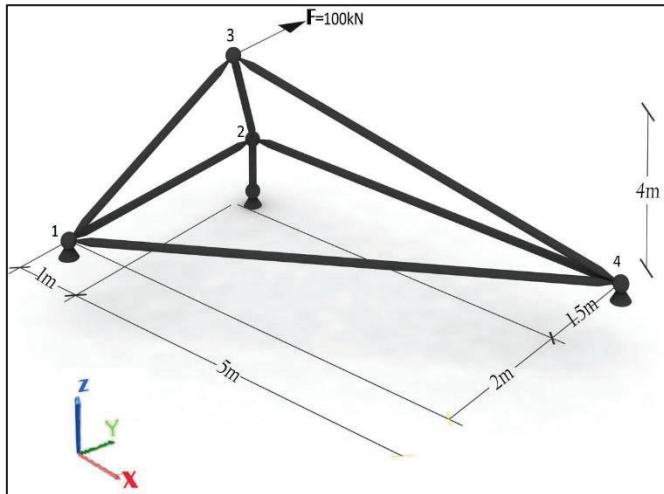

Figure 6. Space truss with six members and four nodes

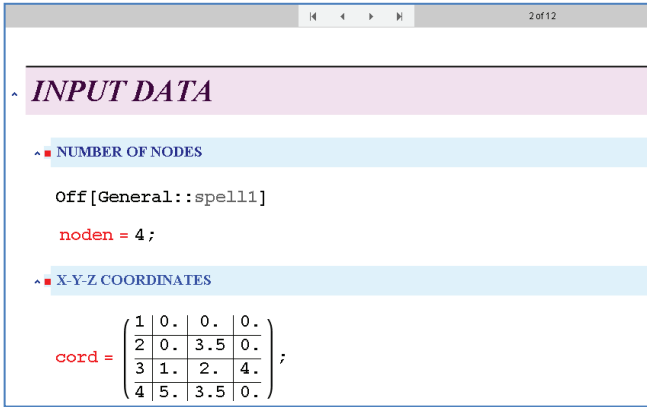

Figure 7. Nodes number and coordinates

Element data input

The user provides element information, such as the number of elements and connection, at this step of the process to indicate the geometry of the truss. The number of elements, starting nodes, and end nodes of each element are displayed in the first, second, and third columns of the $m \times 3$ matrix that makes up this component, where m is the same as the number of members (Fig.8).

Restraint data input

This section describes the joint freedom condition for the $n \times 4$ matrix. The number of joints is shown in the first column, and the conditions of the supports' freedom in the x, y, and z axes directions to be free or constrained in each node are shown in the second, third, and fourth columns. Then, to indicate the degree of freedom, condition 0 will be substituted at the related direction of axes to demonstrate that there is no restriction, and condition 1 will be entered at the supports and nodes where there is restraint in the related direction (Fig.9).

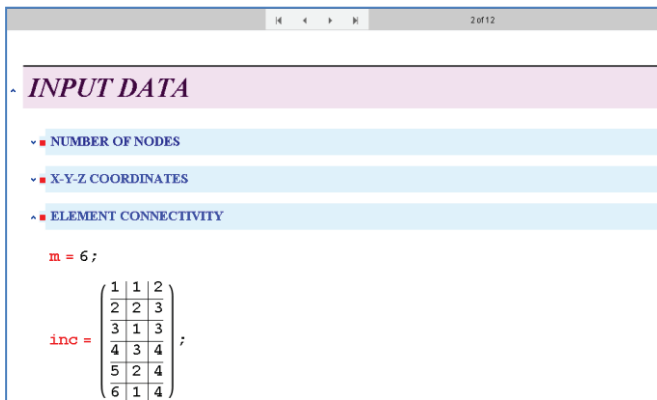

Figure 8. Element number and connectivity

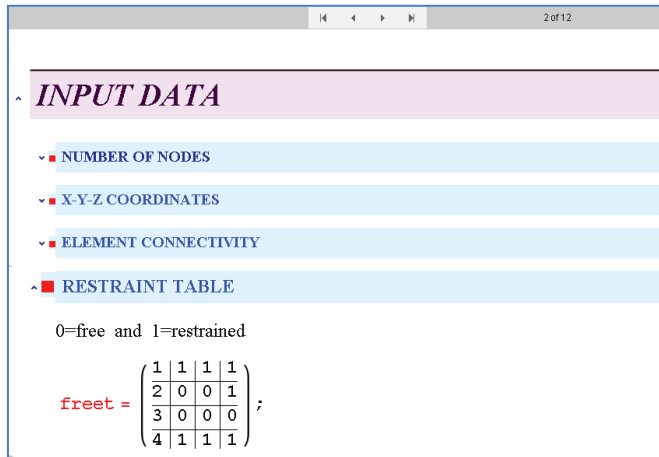

Figure 9. Freedom or restraint conditions of nodes

Loads data input

The user should define the point loads in this section (concentrated load). As seen in Fig.10, if a load is applied at a joint, the value of the load should be recorded in front of that node's number in the appropriate axes direction. If no load is applied, the value zero should be entered. (Fig10).

Materials properties of member

intended modulus elasticity in this study is $E=2 \times 10^8$ and has been entered in related place. The section area of each member is written in $\{A\}$. this programming package has flexibility and members area can be different from each other's Fig.11.

All needed information about truss were entered and now, the programming codes are ready to be run to analyze space truss indicated in Fig.6.

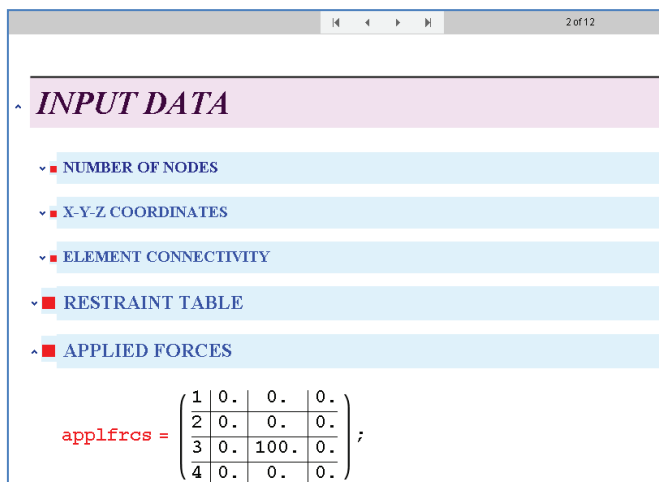

Figure 10. Applied loads at nodes

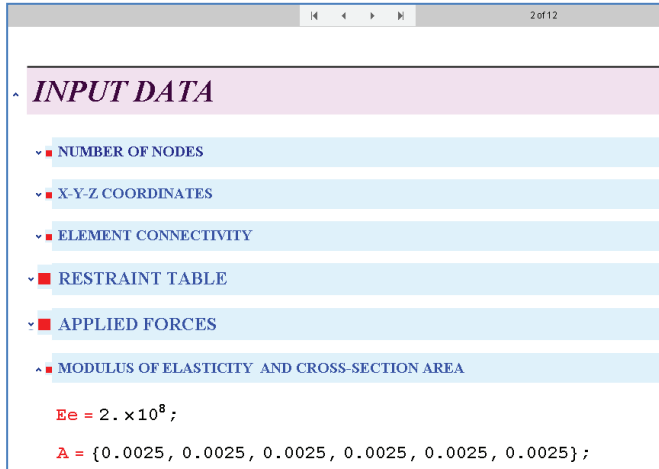

Figure 11. Section area and material properties of elements

RESULTS AND DISCUSSIONS

After running of programming codes, results for members' independent forces, deformations, displacements and support reactions are calculated as shown in Fig. 12-15. The accuracy and correctness of obtained results were tested by MASTAN2 program and results of members' forces, nodal displacements and support reactions have been reported (R. D. Ziemian, and W. McGuire, 2000). Also, several large-scale space trusses were analyzed by prepared programming codes and tested.

```
Pfinal = Pact
{{0.}, {0.}, {0.}, {100.}, {0.}, {0.}}

indFrcs = LinearSolve[ifm, Pfinal]
{{42.8571}, {-125.357}, {130.931}, {0.}, {28.5714}, {0.}}

Print["independent forces ", MatrixForm[indFrcs]]

independent forces  $\begin{pmatrix} 42.8571 \\ -125.357 \\ 130.931 \\ 0. \\ 28.5714 \\ 0. \end{pmatrix}$ 
```

Figure 12. Independent forces of elements (KN)

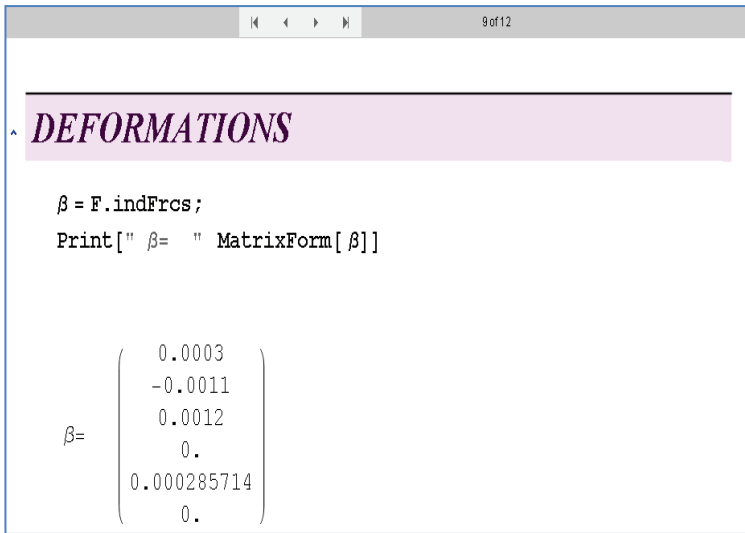

Figure 13. Deformation of elements

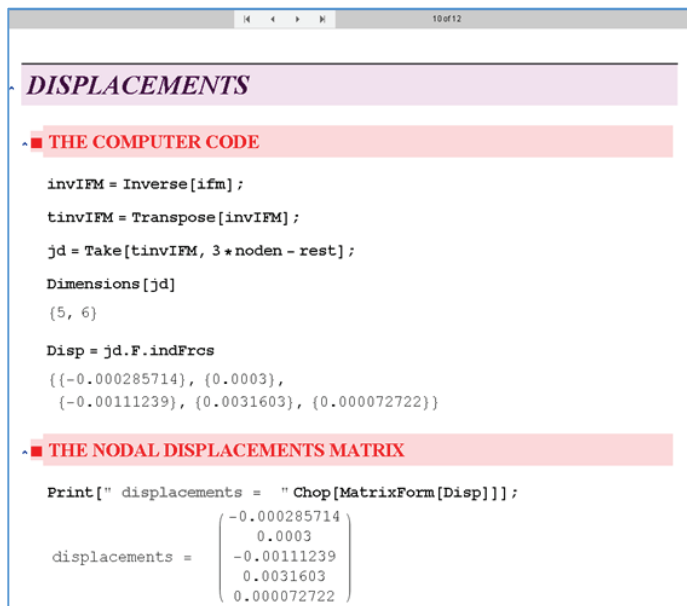

Figure 14. Displacements of nodes (m)

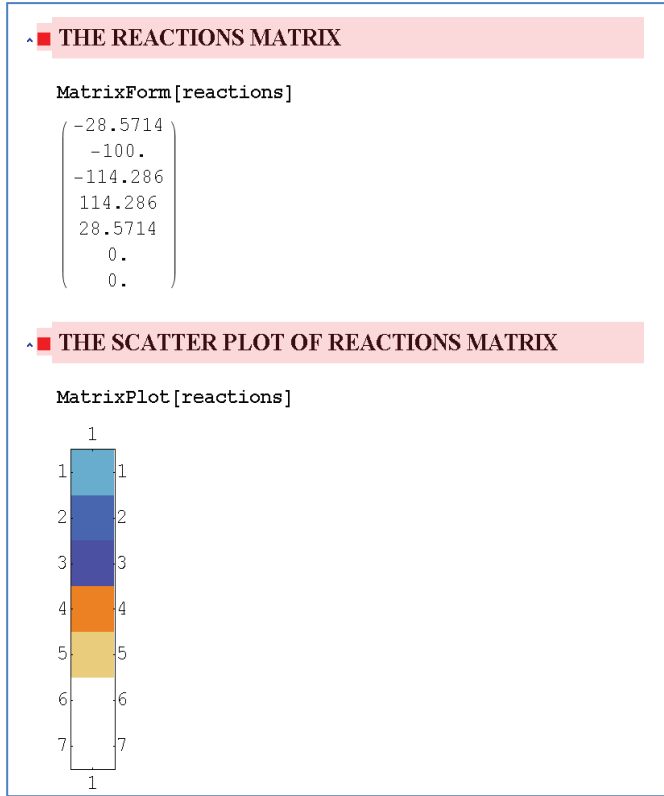

Figure 15. Supports reactions (KN)

Mastan Results for Space Truss

***** MASTAN2 v5.1.26 (August 22, 2022) *****

Time: 01:26:32 Date: 12/17/2022

Problem Title: not provided

 Results of Structural Analysis
 #####

General Information:
 Structure Analyzed as: Space Truss
 Analysis Type: First-Order Elastic

Analytical Results:

(i) Displacements at Step # 1, Applied Load Ratio = 1.0000

Deflections

Node	X-disp	Y-disp	Z-disp
1	0.0000e+00	0.0000e+00	0.0000e+00
2	-2.8571e-04	3.0000e-04	0.0000e+00
3	-1.1124e-03	3.1603e-03	7.2722e-05
4	0.0000e+00	0.0000e+00	0.0000e+00

(ii) Element Results at Step # 1, Applied Load Ratio = 1.0000

Internal End Forces (Note: Refers to local coordinates)

Element	Node	Fx	Fy	Fz
1	1	-4.2857e+01	0.0000e+00	0.0000e+00
1	2	4.2857e+01	0.0000e+00	0.0000e+00
2	2	1.2536e+02	0.0000e+00	0.0000e+00
2	3	-1.2536e+02	0.0000e+00	0.0000e+00
3	1	-1.3093e+02	0.0000e+00	0.0000e+00
3	3	1.3093e+02	0.0000e+00	0.0000e+00
4	3	1.5987e-14	0.0000e+00	0.0000e+00
4	4	-1.5987e-14	0.0000e+00	0.0000e+00
5	2	-2.8571e+01	0.0000e+00	0.0000e+00
5	4	2.8571e+01	0.0000e+00	0.0000e+00
6	1	0.0000e+00	0.0000e+00	0.0000e+00
6	4	0.0000e+00	0.0000e+00	0.0000e+00

Internal End Moments (Note: Refers to local coordinates)

Element	Node	Tx	My	Mz	BiMoment
1	1	0.0000e+00	0.0000e+00	0.0000e+00	0.0000e+00
1	2	0.0000e+00	0.0000e+00	0.0000e+00	0.0000e+00
2	2	0.0000e+00	0.0000e+00	0.0000e+00	0.0000e+00
2	3	0.0000e+00	0.0000e+00	0.0000e+00	0.0000e+00
3	1	0.0000e+00	0.0000e+00	0.0000e+00	0.0000e+00
3	3	0.0000e+00	0.0000e+00	0.0000e+00	0.0000e+00
4	3	0.0000e+00	0.0000e+00	0.0000e+00	0.0000e+00
4	4	0.0000e+00	0.0000e+00	0.0000e+00	0.0000e+00
5	2	0.0000e+00	0.0000e+00	0.0000e+00	0.0000e+00
5	4	0.0000e+00	0.0000e+00	0.0000e+00	0.0000e+00
6	1	0.0000e+00	0.0000e+00	0.0000e+00	0.0000e+00
6	4	0.0000e+00	0.0000e+00	0.0000e+00	0.0000e+00

(iii) Reactions at Step # 1, Applied Load Ratio = 1.0000

Forces

Node	Rx	Ry	Rz
1	-2.8571e+01	-1.0000e+02	-1.1429e+02
2	FREE	FREE	1.1429e+02
4	2.8571e+01	-2.3322e-15	5.9233e-15

#####

End of Results of Structural Analysis

#####

CONCLUSION

This study's primary goal is to demonstrate the use of the integrated force method in space truss analysis through the creation of equilibrium equation. As a result, a computer program is created to automatically produce the equilibrium equations as described. The written programs can also be used for practical and educational purposes.

The usage of written computer coding is to:

- Write and generation of equilibrium equation
- Calculate of flexibility and compatibility condition matrix
- Gather [S] matrix by coupling EE and CC
- Analyse the indeterminate space truss

These computer algorithms shorten and speed up the analytical process, which is a very laborious and time-consuming process for space truss designs.

ACKNOWLEDGMENT

This study is dedicated to the late Assoc. Prof. Dr. Erdiñç Soyer, who had supervised and contributed to this research.

REFERENCES

- E. Soyer, and A. Topcu. (2001). Sparse self-stress matrices for the finite element force method. *International Journal for Numerical Methods in Engineering*, 50(9), 2175-2194.
- Farajzadeh, H. (2012). *Investigation of Space Truss Using the Integrated Force Method*. Gazimagusa: Eastern Mediterranean University.
- Kassimali, A. (2011). *Matrix Analysis of structures*. USA: Cengage Learning.
- N. R. B. Krishnam Raju, and J. Nagabhushanam. (2000). Nonlinear structural analysis using integrated force method. *Sadhana*, 25(4), 353-365.
- Patnaik, S. N. (1999). *Compatibility Condition in Structural Mechanics*. NASA/TM-209175.
- R. D. Ziemian, and W. McGuire. (2000). *Matrix Structural Analysis 2 (MASTAN 2)*. John Willey & Sons.
- S. N. Patnaik and K. T. Joseph. (1986). Generation of compatibility matrix in the integrated force method. *Comp. Meth. Appl. Mech. Eng.*, 55(3), 239-257.
- S. N. Patnaik, and D. A. Hopkins. (1998). Recent advance in the method of forces: Integrated force method of structural analysis. *Advances Engrg. Software*, 29(3), 463-474.
- S. N. Patnaik, D. A. Hapkins, and G. R. Halford. (2004). *Integrated Force Method solution to indeterminate structural mechanics problem*. NASA/TP-207430.
- S. N. Patnaik, D. A. Hapkins, and G. R. Halford. (2004). *Integrated Force Method solution to indeterminate structural mechanics problem*. NASA/TP-207430.
- S.Khosravi. (2005). *Usage of equilibrium Equation in Truss Analysis*. Gazimagusa: Eastern Mediterranean University.
- S.Pellegrino. (1993). Structural Computations with Singular Value Decomposition of the Equilibrium Matrix. *Int. J. Solid Structures*, 30(21), 3025-3035.
- SAOUMA, V. E. (1999). *Matrix Structural Analysis with an Introduction to Finite Elements*. Boulder: University of Colorado.
- Sedaghati, R. (2005). Benchmark Case Studies in Structural Design Optimization Using Integrated Force Method. *International Journal of Solids and Structures*, 42, 5848-5871.
- Wang, C. K. (1983). *Indeterminate Structural Analysis. Civil Engineering Series*. McGraw-Hill.
- West, H. H. (1993). *Fundamental of structural Analysis*. John Wiley & Sons.

“

Chapter 21

AUTONOMOUS CAGE MODEL

Fatih İLKBAHAR¹

Ali Emre TERZİ²

”

¹ Düzce Üniversitesi, İşletme Fakültesi, Yönetim Bilişim Sistemleri Bölümü, Düzce, Türkiye, fatihilkbahar@duzce.edu.tr, ORCID: 0000-0002-7964-3433

² Düzce Üniversitesi, İşletme Fakültesi, Yönetim Bilişim Sistemleri Bölümü, Düzce, Türkiye, m.kahyalar@tirsankardan.com.tr, ORCID: 0000-0001-6826-5310

Many types of pets are bred in our country. It is the cage birds that are highly preferred among the animal species bred. The habit of raising cage birds existed in the Ottoman and Seljuk periods. In the old days, the sounds emanating from the bird cages hanging on the walls of the houses were very pleasing to the people passing by on the streets. This beautiful heritage from our culture is being tried to be continued today and many domestic cage bird species are found at home in our country. Some of those; are pigeons, parrotidae, finch, and nightingales. There are many genera of these species. One of them is the budgerigar, which is scattered all over the world as a pet cage bird among the parrots. The budgerigar got its name from its ability to talk to people, as it is used to living in a cage as a couple and not in constant communication with each other. Budgerigars are one of the most widely grown domestic cage birds in our country, as they have various pleasant colors, are easy to care for, and can imitate sounds. Although budgerigars vary according to their species, they have an average length of 18 cm and a weight of 42-48 grams. Male budgies are more prone to speech, while female budgies are more difficult to learn to speak. For budgerigars to continue their lives healthily, they need to get the protein, energy, minerals, and amino acids they need from outside. They usually feed on plant seeds. There are ready-made feeds consisting of mixed plant seeds containing bird sand, vitamins, and minerals. In addition, some feeds contain additional nutritional supplements, as they will need more phosphorus and calcium during the molting and spawning period. We give these feeds to our birds in feeders that comply with cage standards and cage bird species. Along with technology, new feeder forms have also emerged. The design of the manger is in some mechanical types, with those that hang inside or outside the cage. The design of feeders is increasingly being used in ways that are easier to fill and contain more feed (Petek, 2004, p.131).

As a result of the development of technology, sustainable products have become used in almost every part of our lives. Sustainable products are important products that will ease our workload in our daily lives. These developed designs ease our responsibilities or make our work easier while performing our daily routines. Products developed by examining environmental, economic, and social areas are more advantageous for future generations. Today, technology has become an indispensable place for people to connect with their environment. Technology has caused significant changes in people's lifestyles. For example, even the stone oven used to make bread or the fire you will use to heat a meal is a product of technology (Günay, 2017, p.163).

When the development stage of technological products is examined, we see that some designs or products are considered very primitive compared to today. Today, in modern technology, we have become able to

control even inanimate objects without getting up or intervening. Thanks to smart systems, we have automated our groping controls and achieved high savings rates in the most beneficial way for humanity. Smart homes built using smart devices have become the focus of attention today. There are many smart home appliances in these houses and they make the homeowners' job easier by working on their own. These can be exemplified as smart heating, cooling, lighting, cleaning, and security systems. In addition to these, smart pet feeding systems are also made (Gökrem and Bozuklu, 2016, p.49).

While carrying out today's technological studies, it is important that it can support different platforms suitable for multiple purposes and usage areas. Care is taken to ensure that the work carried out is sustainable. Open-source code physical programming cards are generally preferred for the studies to be developed. Arduino board is frequently preferred in smart systems due to its easy programmability and low cost (Lwin et al., 2019, p.904).

There are still products and projects produced for the consumption of dry food only. In the study, it works with time and amount adjusted. Therefore, the suitability of these projects is limited to domestic animals such as cats, dogs, and rabbits, which are fed a certain amount of meals at certain times a day. There is no automatic feeding system project for cage birds yet. The diet of cage birds is different from that of cats and dogs. Cage birds eat when they are hungry. They do not have a regular feeding interval, they also produce forage shells while eating. For this reason, mechanical feeders with evacuation systems have been made, but these will not provide feeding after a while if pet-caged birds are left alone at home for a long time. In this article, I will talk about the Arduino Uno-based automatic budgie feeding system that I have developed for situations where we need to leave our budgies or other pet-caged birds alone at home for a long time. This project is based on Arduino Uno and works successfully wherever there is city electricity as it gets its power from the city electricity via the adapter. The system consists of a bait tank fixed on the cage and an externally mounted manger that can evacuate the bait shells. In similar projects working with dry food, the filling process was done via SMS or a timer system. These methods will not be successful in cage bird feeders. In the feeding method by sending an SMS, the person cannot detect whether the feed has decreased. In these conditions, if our pet has consumed less feed, if we fill it without seeing it, we will cause the feeder to overflow, or if we have a pet that consumes too much feed, if the feed runs out, it will cause them to starve until the next filling. We also encounter the same problems in the feeding method using a timer, which is another method (Clavero et al., 2015, p.234).

Another feature that distinguishes this study from others is that it does not fill the feed at a certain time interval, but when the feed in the feeder falls below a certain level. To achieve this, I used an ultrasonic distance-sensing sensor in the project. In this way, we will be able to keep the feed level in balance without any supervision. locking) the effect was investigated.

One of the automatic pet-feeding systems made today is the timed pet-feeding vending machine with an LCD control panel. It is based on the principle of feeding the pet at the time entered by setting the time with the keypad from the LCD screen panel on this vending machine. The disadvantage of this device is that it can only feed one pet and the size of the device is not suitable for use with caged birds. This device has been developed for cats and dogs (Koley et al., 2021, p.1).

There are also mechanical feed vending machines that work with the gravity principle without the need for any electronic control. These vending machines push the feeds placed in the feed tank out of the opening at the bottom with a heaping movement, and when the outer chamber is full, it gets stuck and the pushing process stops. These systems are also used in cage birds, but their disadvantage is that they do not have a sufficiently large chamber (Juhan et al., 2020 p.15).

In another system, there are multiple bait eyes on the circular body as a working principle. These feed eyes are opened at certain hour intervals, allowing the pet to be fed. The disadvantages of this device are that it does not feed outside of certain hours, the volume of the feed chamber is low, it can feed a single pet and it is not suitable for domestic cage birds. This product is also designed for domestic cats and dogs only (Juhan et al., 2020 p.18).

There are feed vending machines where we can adjust both the time and the portion amount. These vending machines can be controlled by the buttons on them. In this system, which can also be controlled with remote control, there is an option for the number of feedings 1-5 times a day and the number of meals between 1-12 portions. The disadvantages of this device are that it is expensive, not suitable for cage birds, cannot be controlled with mobile applications, and is difficult to control with the control system (Juhan et al., 2020 p.17).

The most advanced feed vending machines today are feed vending machines with wi-fi control. We can control these devices from anywhere via smartphones. There is also a spare battery and a camera on these devices. Thanks to this camera, we can check our pet or see if there is food in the feed hopper. The disadvantages of this device are that it needs a fixed internet line because it works with a battery, the battery will run out in

long-term use, it poses a fire risk if it is left on the charger, it is not suitable for cage birds and its cost is high (Juhan et al., 2020 p.21).

In the article produced from a project, there is a GSM-controlled pet-feeding vending machine. In this vending system, the feed in the feed tank is poured into the feeder by gravity when the solenoid valve is opened. For this to happen, you need to perform the feeding process by sending an SMS to the system via the GSM shield card installed in the system. The disadvantages of this vending machine are that it is costly, not suitable for domestic cage birds, it cannot be controlled whether there is feed in the feeder and the feed tank is small (Clavero, 2015, p.233).

2. MATERIAL AND METHOD

This research was carried out because there is no automatic feeding machine for domestic cage birds and there is a need for it. Considering the deficiencies found in previous studies for different pet species, a design was made to eliminate these deficiencies and facilitate the use of the system. In this study, feed control was performed using an ultrasonic distance sensor. The ultrasonic distance sensor is located on the mechanical feeder tank, which is mounted from the outside of the cage. This way, we can control the feed amount in the feed by entering certain parameters. To supplement feed, there is a feed supplement system positioned on the cage. This system consists of 4 parts: the feed tank, the movable tank cover, the filling chamber, and the booster hose.

Arduino Uno R3 microcontroller board was used to measure the amount of feed in the feed chamber and to move the feed tank cover to start feeding. HCSR04 ultrasonic distance sensor was preferred for feed amount control. A cover system connected to the SG90 servo motor is designed to open and close the feed tank. To process the signals received from the sensor and actuate the feed tank cover, a parameter has been determined for the ultrasonic sensor. In this way, when the feed goes below a certain distance, the cover at the outlet of the feed tank will open and allow free feed flow. After the feeder fill level exceeds the parameter, the lid closes again and cuts off the feed flow.

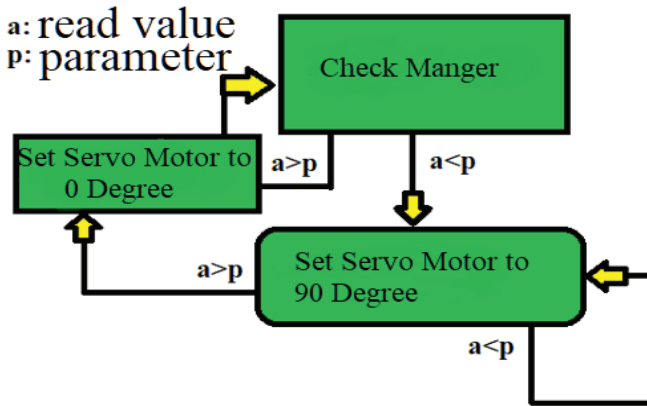

Figure 1 Flowchart of the Study

The control cards required to control the physical hardware are microcontrollers. The open-source and low-cost Arduino Uno R3, which contains the requirements for operation, meets the needs of reading ultrasonic sensor data and moving the servo (Figure 2).

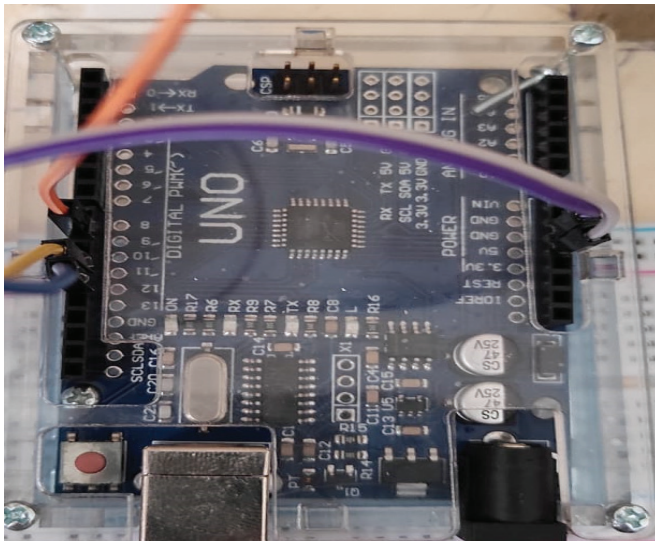

Figure 2. Arduino Uno R3

2.1 HC-SR04 Ultrasonic Distance Sensor

The HC-SR04 ultrasonic distance sensor, which is used to control the feed amount in the feed, can measure between 2 cm and 4 meters. This sensor, which is suitable for measuring ranges, works in a structure suitable for vertical measurement with its 15-degree viewing angle (Figure 3).



Figure 3. Hc-SR04 Ultrasonic Distance Sensor

2.2SG90 Servo Motor

The SG90 servo motor we use to help open the lid of the feed tank for feed supplementation is a mini servo motor that can carry a maximum load of 1.6 kg. It has been observed that the SG90 servo motor works successfully since there are no high load values in the study (Figure 4).



Figure 4. SG90 Servo Motor

2.3 Feed Tank Cover

There were no pauses or jams during the experiment. The feed tank cover works successfully and fluently. Its design is presented in Figure 5.



Figure 5. Feed Tank Drain Cover

2.4 Reinforcement System

There was no disruption in the additional feed installation that provides feed flow from the feed-filling system to the feeder. As shown in Figure 6, there were no pauses or obstructions during the test. A wide hose system is used to provide comfortable feed flow. In addition, a funnel system is positioned under the feed tank to prevent feed loss during the reinforcement process from the feed tank. The installation, which is inclined in a way that the flow can be provided comfortably as a structure, has successfully performed its function.

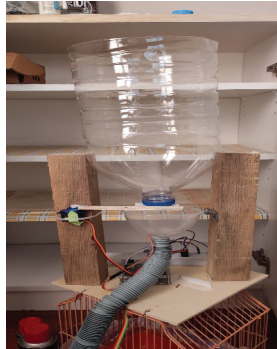

Figure 6. Reinforcement System

The ultrasonic distance sensor works quickly and fluently from the first opening and reading. As shown in Figure 7, it makes continuous and successful measurements. In this way, the servo works instantly when the feed decreases by giving a signal to the microcontroller. This was revealed by observing the movements of the servo in the decrease in the manger during the experiment (Louis Leo,2016).

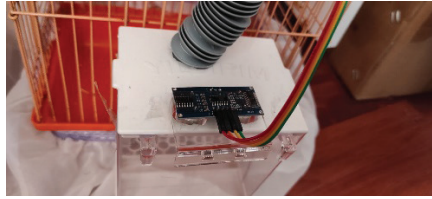

Figure 7. Ultrasonic Distance Sensor on Feeder

3. EXPERIMENT AND FINDINGS

The results of the experiments are presented in Table 1. As shown in Table 1, a deviation of 0.6 seconds was observed in the filling time. There is a 5% difference between the filling quantities. The system worked successfully in the experiment. Due to the heterogeneous structure of the feed mixture, there are small time and amount differences between the fillings due to the weight difference between the feeds, but as a result, the filling process is balanced and successful.

Table 1. Findings for the prototype

Experiment Id	Fill Time	Occupancy Rate
1	8,4 sec	%82
2	8,7 sec	%80
3	9 sec	%85
4	8.5 sec	%85

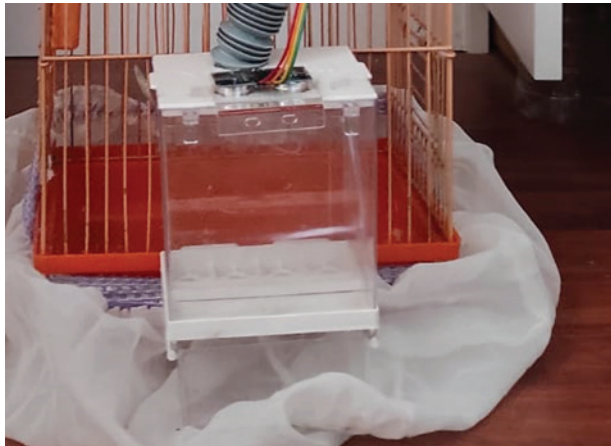

Figure 8. Manger

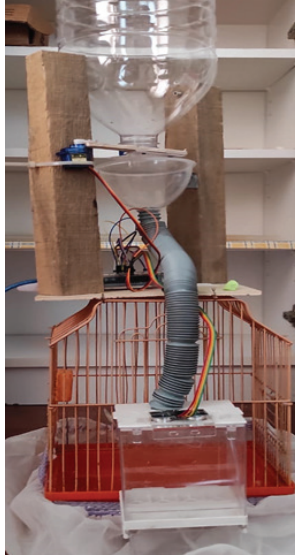

Figure 9. The appearance of the Prototype

8. RESULT

There are automatic feeding systems suitable for many types of pets. It is presented in this study as a first for the automatic feeding systems that do not have any derivatives for domestic cage birds and it has been observed that it works with a great success rate. Thanks to the proposed system, it is thought that it will be beneficial for people who are eager to keep pet cage birds and cannot spare time for their pets in the future. It is thought that there will be a decrease in the number of pets that can not be fed due to the forgetfulness or irresponsibility of some pet owners. It is expected that pets will have a better time with humans. They will be able to devote the time that people spare for the care of their animals to loving their animals a little more. Unfortunately, it is known that pets die due to reasons such as loneliness and hunger, which we often read about in the news. Therefore, it causes psychological diseases and traumas for pet owners who die. It is thought that the proposed study will contribute to the reduction of similar problems. It has been observed that in situations such as pandemics, it has been observed that people, especially children, as result of communicating with animals, increase many features in human beings, and turn into behaviors by experiencing many concepts such as pity, friendship, sharing, and responsibility.

Description

This study is an output of the Artificial Intelligence and Applications course. For his contributions, Dr. Fatih İLKBAHAR Thank you.

REFERENCES

- Koley, S., Srimani, S., Nandy, D., Pal, P., Biswas, S., & Sarkar, I. (2021, February). Smart Pet Feeder. In *Journal of Physics: Conference Series* (Vol. 1797, No. 1, p. 012018). IOP Publishing.
- Azan, M. A. H. B. M., Juhan, N. H. B. M., Zamri, N. B. M., & Daud, D. M. E. B. (2020). Smart Pet Feeder.
- Beltran, A. A., Clavero, A. R., De Vera, J. M. B., Lopez, P. A. P., Mueca, C. A., IX, N. A. P., & Roxas, A. Z. D. (2015). Arduino-based food and water dispenser for pets with GSM technology control. *International Journal of Scientific Engineering and Technology*, 4(4), 231-234.
- Petek, M. (2004). Kafes kuşları. *Uludag University, Journal of Faculty of Veterinary Medicine*, 23, 1-2.
- Çetingül, I. S., Gültepe, E. E., Uyarlar, C., Iqbal, A., & Bayram, I. Afetzedede Kanatlı Hayvanların Beslenmesi.
- GÜNAY, D. (2017). What is Technology? A Philosophical Approach. *Journal of Higher Education and Science*, 7(1), 163-166.
- Gökrem, L., & Bozuklu, M. (2016). Nesnelerin interneti: Yapılan çalışmalar ve ülkemizdeki mevcut durum. *Gaziosmanpaşa Bilimsel Araştırma Dergisi*, (13), 47-68.
- Irawan, Yuda, Refni Wahyuni, and Hendry Fonda. "Folding Clothes Tool Using Arduino Uno Microcontroller And Gear Servo." *Journal of Robotics and Control (JRC) 2.3* (2021): 170-174.
- Kadhim, Riadh Adnan, A. K. K. A. Raheem, and Sabah Abdul Hassan Gitaffa. "Implementing of liquid tank level control using Arduino-LabView interfacing with ultrasonic sensor." *Kufa Journal of Engineering* 8.2 (2017): 29-41.
- Arízaga, Juan Antonio, et al. "Automatic control for laboratory sterilization process based on arduino hardware." *CONIELECOMP 2012, 22nd International Conference on Electrical Communications and Computers*. IEEE, 2012.
- VanHuy, Tran, et al. "Simple robotic hand in motion using arduino controlled servos." *International Journal of Science and Research (IJSR)* 6.3 (2017): 972-975.
- Rathy, G. A., Aravind Balaji, and Tamil Nadu. "Arduino based 6dof robot using labview." *International Journal of Advance Research, Ideas and Innovations in Technology* 4.1 (2018): 354-358.
- Beltran, Angelo A., et al. "Arduino-based food and water dispenser for pets with GSM technology control." *International Journal of Scientific Engineering and Technology* 4.4 (2015): 231-234.
- Nu, Yin Yin, and Win Win Maw San San Lwin. "Automatic Plant Watering Sys-

tem using Arduino UNO for University Park.” (2019).

Keskin, Muharrem, and D. Saribaş. “Contanier Level Measurement Methods and Testing an Ultrasonic Level Sensor.” International Advanced Resarches&Engineering Congress, Osmaniye. 2017.

Sunitha, S. “Distance measurement using ultrasonic sensor and NodeMCU.” International Research Journal of Engineering and Technology 4.6 (2017): 1794-1797.

Latha, N. Anju, B. Rama Murthy, and K. Bharat Kumar. “Distance sensing with ultrasonic sensor and Arduino.” International Journal of Advance Research, Ideas and Innovations in Technology 2.5 (2016): 1-5.

Gabriel, Mutinda Mutava, and Kamweru Paul Kuria. “Arduino Uno, Ultrasonic Sensor HC-SR04 Motion Detector with Display of Distance in the LCD.” International Journal of Engineering Research And, V9 5 (2020).

Mehta, Shreyes, and Shashank Tiwari. “Radar system using Arduino and ultrasonic sensor.” International Journal of Novel Research and Development 3.4 (2018): 14-20.

Asfiansyah, Zul, Rozeff Pramana, and Deny Nusyirwan. “Water Level Control System Of Tilapia Ponds Using Arduino-Based Ultrasonic Distance Sensor.”

Oral, Okan, and M. Çakır. “Nesnelerin interneti kavramı ve örnek bir prototipin oluşturulması.” Mehmet Akif Ersoy Üniversitesi Fen Bilimleri Enstitüsü Dergisi 1 (2017): 172-177.

Arun Francis, G., et al. “Object Detection Using Ultrasonic Sensor.” Int J Inno Technol Explor Eng (IJITEE) 8.5 (2020): 207-209.

Priyati, A., et al. “The Design of Automatic Sprinkler based on Arduino Uno Microcontroller.” IOP Conference Series: Earth and Environmental Science. Vol. 355. No. 1. IOP Publishing, 2019.

Sihombing, P., et al. “Automated hydroponics nutrition plants systems using arduino uno microcontroller based on android.” Journal of Physics: Conference Series. Vol. 978. No. 1. IOP Publishing, 2018.

Louis, Leo. “working principle of Arduino and using it.” International Journal of Control, Automation, Communication and Systems (IJACS) 1.2 (2016): 21-29.

“

Chapter 22

**SLUDGE DISINTEGRATION
METHODS TO ENHANCE ANAEROBIC
DIGESTION: AN UP TO DATE REVIEW**

F. Olcay TOPAÇ¹

”

¹ Prof.Dr. F. Olcay Topaç, Bursa Uludag University, Department of Environmental Engineering, ORCID: 0000-0002-6364-4087, olcaytopac@uludag.edu.tr

Introduction

Due to environmental concerns caused by changes in the amount and quality of wastewater discharges, the treatment of municipal wastewater with appropriate methods has been one of the most important environmental priorities in recent years. The treatment method, which is the most widely used and one of the most effective processes in the treatment of waste effluents, is undoubtedly the activated sludge process. This biological process is categorized within the suspended growth processes. In this method, the microorganisms that provide the treatment are kept suspended in the liquid by mixing the wastewater. The process is called as the activated sludge process because there is an active mass of microorganisms in the wastewater that can stabilize organic matter under aerobic conditions. The wastewater from the aeration pond passes to a clarifier, where more than 99% of suspended solids can be removed and a clear effluent can be obtained. At this stage, suspended solids that are separated from the wastewater and still contain active microorganisms are called “waste activated sludge”.

The increment in the number of wastewater treatment facilities, the increasingly stringent regulations regarding wastewater discharges and the developing technologies to achieve higher efficiency in wastewater treatment cause an increase in the amount of sludge produced all over the world (Hanum et al., 2019). Since the activated sludge process is the most common way of waste effluent treatment, it is of great importance to properly manage the large volumes of waste activated sludge and to minimize the associated environmental risks. Waste activated sludge, which consists of different proportions of cellular biomass, mineral matters and persistent organic compounds, also contains various organic and inorganic pollutants as well as pathogenic organisms, which makes waste activated sludge management a challenging task for environmental professionals (Ennouri et al., 2016; Feki et al., 2020). Therefore, there is an increasing interest in reducing the volume of waste activated sludge and stabilizing it in a way that does not harm environmental ecosystems and human health. In addition, the sludge treatment unit is the most costly part of the wastewater treatment plants and constitutes approximately 60% of the total operating costs. Therefore, increasing amounts of waste activated sludge formation also significantly magnifies the cost of wastewater treatment plants and creates economic concerns.

Anaerobic digestion process is one of the most common, fruitful and attractive treatment techniques for excess sludge produced from biological wastewater treatment facilities. In this method, which is performed in the lack of oxygen, the excess sludge is biodegraded and transformed into an energy-rich gas called biogas. Since the methane content of the resulting

biogas is between 55 and 70%, it has the potential to be used for electricity generation (Robson et al., 2016; Ward et al., 2008). Therefore, this method is considered as an environmentally promising method that not only eliminates the need for aeration and associated costs, but also enables the production of biogas as a clean, renewable, and reliable source of energy in wastewater treatment facilities (Iglesias et al., 2021; Zhang et al., 2016).

Besides all these advantages, an apparent problem attributed to the anaerobic sludge digestion process is the weak biochemical methane potential and slow fermentation process. The handicaps such as long hydraulic retention times (usually more than 20 days) and solids reduction reaching only a maximum of 50% made it necessary to work on improving the performance of this conventional sludge treatment technique.

The anaerobic digestion process consists of four consecutive steps (hydrolysis, acidogenesis, acetogenesis and methanogenesis) and the digestion efficiency depends on the interaction between the microbial consortium that can perform these four steps (Verma 2002). Figure 1 indicates a simplified course of the four anaerobic digestion steps. Since the degradation rate of the waste sludge consisting of biomass is very slow, the hydrolysis is accepted as the time limiting step in anaerobic digestion of the excess sludge (Meegoda et al., 2018)

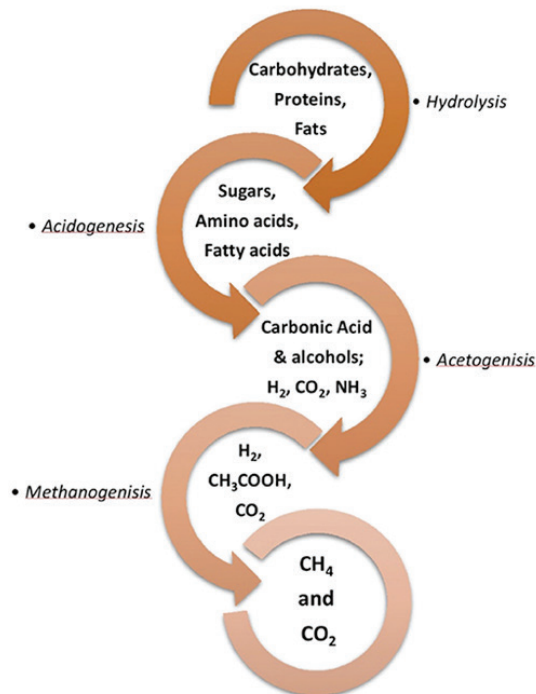

Figure 1. Four consecutive steps in anaerobic digestion (Prajapati et al., 2018).

In the process of hydrolysis, hydrolytic microorganisms can degrade the insoluble complex organic matter like carbohydrates, proteins and lipids into soluble components by the help of secreted extracellular enzymes (Janesch et al., 2021). Hydrolysis plays an essential role in the kinetics of anaerobic digestion, since hydrolysis products can only pass across the cell membranes of microorganisms responsible for acidogenesis after enzymatic cleavage. Therefore, great attention has been paid to the methods applied to accelerate hydrolysis in anaerobic digesters. Pre-treatment methods, which are called sludge disintegration methods, are generally used to lower the molecular weight of sludge contents, to destroy the cell walls of microorganisms, to release intracellular substances and, as a result, to accelerate anaerobic digestion (Ahn and Chang, 2021; He et al., 2021).

Recently, many sludge disintegration methods with different approaches are used that increase the performance of anaerobic digesters by accelerating hydrolysis. In this chapter, the effectiveness of chemical, physical/mechanical and biological sludge disintegration methods as well as combined (hybrid) processes are evaluated, their principles are explained and relevant up to date studies are discussed.

Sludge Disintegration

In order to improve anaerobic digestion and increase process performance, many pretreatment/disintegration methods consisting of chemical, physical/mechanical and biological techniques alongside their combinations are used (Figure 2). With the application of sludge disintegration methods, the accessibility to the floc structure of the sludge increases, the composition of the compounds in sludge is simplified and becomes suitable for microbial degradation, which increases the biogas production. During the disintegration carried out, the floc structure of the substrate deteriorates and the particle size decreases. As a result, particles with increased surface area support enzymatic activities and promote the dissolution of organic particulate matter by increasing hydrolysis. In addition, resistant cell walls are disrupted due to pretreatment, increasing the release and subsequent solubility of intracellular compounds, making these compounds available to a consortium of microorganisms. (Volschan Junior et al., 2021). Disintegration processes applied to the sludge also affect the dewatering properties of the sludge. The applied processes demolish the EPS matrix in the sludge and cause the bound water to be released, which positively affects the dewaterability of the sludge (Wei et al., 2018).

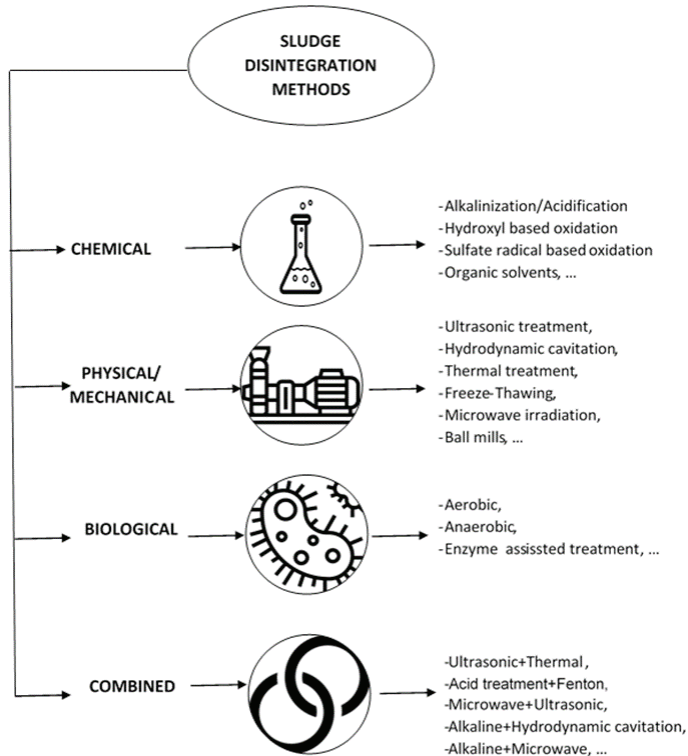

Figure 2. The available sludge disintegration methods

The application of sludge disintegration processes changes the structure of the sludge, improves its solubility and bioavailability, and thus increases the rate of degradation of the organic matter in the sludge. With this increase in hydrolysis, hydraulic retention time is reduced, and the biogas efficiency of the system increases. In addition, the limitation of the reactor volume requirement provides an economic advantage. Moreover, with the increase of anaerobic digestion performance, the solid matter content in the digested sludge decreases as well as the sludge disposal costs (Mitraka et al., 2022). In recent years, a great deal of studies have reported various disintegration methods with a wide range of principles and consequences. Considering the benefits they provide, sludge disintegration methods still receive high scientific interest in the academical society.

Chemical Disintegration Methods

Chemical disintegration processes are recognized as efficient and cost-effective processes that increase the solubility of organic substances by destroying membranes and cell walls. Among these chemical-based methods, the most commonly used ones are alkali treatment and acidification.

The pH value that rises with the addition of alkaline substances to the sludge causes some alterations in the sludge constituents and surface characteristics as well as in the net charge of EPS matrix. As a result of the excessively high pH values in the excess sludge, the cells in the activated sludge lose their viability and cannot maintain the appropriate turgor pressure, resulting in cell deterioration. Furthermore, added alkaline substances can interact with cell walls in various ways (such as saponification of lipids), which leads to membrane dissolution. In addition, deprotonation of functional acidic groups such as carboxylic groups in EPS under alkaline conditions causes electrostatic repulsions between negatively charged EPS, which probably leads to increased disintegration (Gonzales et al., 2018).

A great deal of researches have been carried out examining the effects of alkaline disintegration on sludge characteristics and evaluating the achievement of the system. Dahou et al. (2022) conducted an experimental trial investigating the influence of NaOH on biogas production. The results achieved after a digestion period of 60 days indicated that with the addition of approximately 2.5% NaOH, the biogas production increased by 42.6% in comparison to raw sludge. It was also found that methanogenic activity was inhibited at higher NaOH concentrations and the digestion process was suppressed. In a similar study, batch experiments were conducted using NaOH to disintegrate the excess sludge prior to anaerobic digestion. The results of the study showed that the optimum dose of NaOH was 0.1 mol/L. The organic degradation rate was 8.3% and the biogas yield was 0.65 L/g volatile suspended solids (VSS) in the sludge treated by NaOH under optimized conditions, while these values for the control were found as 30.3% and 0.64 L/g, respectively (Li et al., 2012). In another study, alkaline pretreatment was applied at different pH values (pH 10, 11 and 12 for 1 hour) to reduce the production of sludge in a laboratory scale anaerobic-anoxic-oxic system. Based on the results of the 99-day study, alkaline pretreatments at pH 10 and 11 were able to produce varying degrees of reduction in excess sludge production. On the other hand, the alkaline treatment carried out at pH 12 caused the system to discontinue due to the sludge bulking problem (Zhang et al, 2018).

In case of acidic disintegration applications, the pH value of the sludge is adjusted to 1 - 5.5 levels with the addition of acid, and the most commonly used chemical reagents are HCl, H₂SO₄, H₃PO₄ and HNO₂. Throughout the acidification process, polymers are broken down into oligomers and monomers, similar to the alkaline process, thus facilitating hydrolysis and increasing the rate of hydrolysis (Neumann et al., 2016). In a study conducted by Szypulska et al. (2021), free nitrous oxide was applied to the waste activated sludge (0.0 to 352.7 mgHNO₂-N/L) for 6

days. The results of BMP tests indicated that acid concentrations below 3.7 mgHNO₂-N/L did not lead to an increment in the methane potential. After this level, the methane potential increased due to the increase in acid concentration, but it was determined that acid concentrations above 6.4 mgHNO₂-N/L no longer increased the biomethane potential. Nava-Valente et al. (2022) studied the use of acetic acid for acidic degradation of sewage sludge and agro-industrial waste mix. Their results showed that the acidic disintegration conditions that significantly enhanced the biogas yield were a 4% acetic acid dose and a reaction time of 90 minutes ($Y_{bio}=609\pm 11.7$ to 1857.2 ± 7.5 Lbio/gVSrem). Although many existing studies have shown that acidic pretreatment remarkably enhances the solubility of sludge organic constituents and biogas yield, it is concluded that alkaline pretreatment is generally a more effective method for sludge disintegration (de Sousa et al., 2021, Maspolim et al., 2015).

Besides alkaline and acid pretreatments, oxidation techniques such as ozone pretreatment, Fenton oxidation, sulfate oxidation, etc are also often used for sludge disintegration purposes because of their tremendous effectiveness. Chiavola et al., (2019) studied the effects of ozonation pretreatment on anaerobic digestion of sludge and evaluated the increase in methane production for different specific ozone dosages. According to their results, the dose range of O₃ that increases methane production is between 0.0035 and 0.15 g O₃/g TS. In another similar study, it was emphasized that ozone pretreatment accelerated the mechanism of methanogenesis and it was found that the maximum daily amount of biogas, which was 2.08 L biogas kg⁻¹ VS.d⁻¹ for untreated sludge, reached to 6.26 L biogas kg⁻¹ VSd⁻¹ for ozone-treated sludge (Hodaei et al., 2021). In another study where Fenton's reagent was used for sludge disintegration, the most suitable process conditions were determined as 0.08 g Fe²⁺/g d.m and the Fe²⁺:H₂O₂ ratio of 1:5. Under these optimum conditions, the SCOD value in the sludge increased 7 times compared to the initial level. According to the results of fermentation study, the biogas yield in the pre-treated sludge increased by 35% compared to the untreated sludge (Zawieja and Brzeska, 2019).

Some recent studies have shown that sulfate-based oxidation is also an effective method for sludge disintegration. It is demonstrated that with the oxidative effect of sulfate radicals, cell membrane/wall, intracellular genetic materials and protein content are degraded thus causing inactivation of microorganism (Xiao et al., 2019). According to a study by Sari-Erkan (2019) the disintegration degree (DD) values in terms of soluble COD of the disintegrated sludge with the addition of peroxy mono sulfate and peroxydisulfate were found to be 9.40% and 6.03%, respectively, under optimum conditions. Sun et al. (2012) evaluated the disintegration effect of sulfate radical (SO₄⁻) pretreatment on the anaerobic digestion performance

of waste sludge and concluded that persulfate / $K_2S_2O_8$ application could be an influential approach to increase methane yield. It was determined that the cumulative amount of biogas produced was increased by 44.9% with the effect of sulfate radicals.

Advantages such as the effectiveness of chemical disintegration methods and the ease of operation they offer make these methods preferred especially for the disintegration of sludge containing recalcitrant organic compounds. However, the disadvantages associated with equipment corrosion, the generation of inhibitory byproducts, and the elevated costs of purchasing chemicals make these methods not as preferable as physical disintegration methods (Mitraka et al., 2022).

Physical/Mechanical Disintegration Methods

Physical/Mechanical disintegration of waste sludge refers to processes that reduce the particle size of solid particles by performing a physical force to the sludge. The organic compounds in the sludge are transformed into smaller and easily soluble fractions by the effect of the applied force. Thus, thanks to the increased surface area of the organic substances in the sludge, the possibility of contact between these sludge constituents and the microorganisms in the anaerobic reactor and thus the biodegradability of the sludge increases and the anaerobic digestion process improves (Shrestra et al., 2020). The effects of physical/mechanical degradation of waste activated sludge on the success of the anaerobic digestion process has been a long-standing research topic in the field of environmental technology. Heat treatment, ultrasonic cavitation, hydrodynamic cavitation, microwave treatment, grinding technology and high pressure technology, electrokinetic treatment are some of the main physical/mechanical disintegration techniques. With the application of mechanical forces to the waste activated sludge, the flocs are destroyed, the intracellular organic substances are liberated by the disintegration of the bacterial cells, and finally the amount of biogas obtained at the end of the anaerobic process increases (Tyagi and Lo, 2011).

Ultrasonic pretreatment is another practical and promising practice for waste sludge disintegration. This mechanical method allows the sludge to be disintegrate with the effect of cavitation phenomenon and is widely used as a sludge pretreatment method. The spreading of acoustic waves that have frequencies lying between about 20 and 40 kHz in the waste sludge causes pressure variations and as a result microbubbles are formed. These microbubbles grow in successive cycles, when they reach a critical size they collapse violently, creating shock waves (Figure 3). This intense energy released into the sludge causes high temperature and pressure conditions (5000K, 500 bar), and under the influence of

these conditions, the sludge structure is deteriorated and the cell walls are broken. In addition, reactive radicals formed by the cavitation effect also contribute to sludge disintegration (Mitraka et al., 2022). In the study by Roebuck et al. (2019), it was concluded that the biogas yield obtained from the sludge pretreated by ultrasonic irradiation increased significantly. While the biogas production of treated waste activated sludge and lagoon sludge increased by 5-12%, the increase in biogas production of biofilm type sludge was greater (15-20%). The study results showed that different types of sludge respond differently to the same sonication energy levels with respect to biogas yield. In another study, it was found that the total biogas production increased by 13-19.7% with the ultrasonic pretreatment applied to the waste activated sludge prior to anaerobic digestion. It was also determined that the total solids and volatile solids contents decreased by 4.1-8.2% and 5.8-9.5%, respectively, which confirms the effectiveness of ultrasonic disintegration (Tytila, 2018).

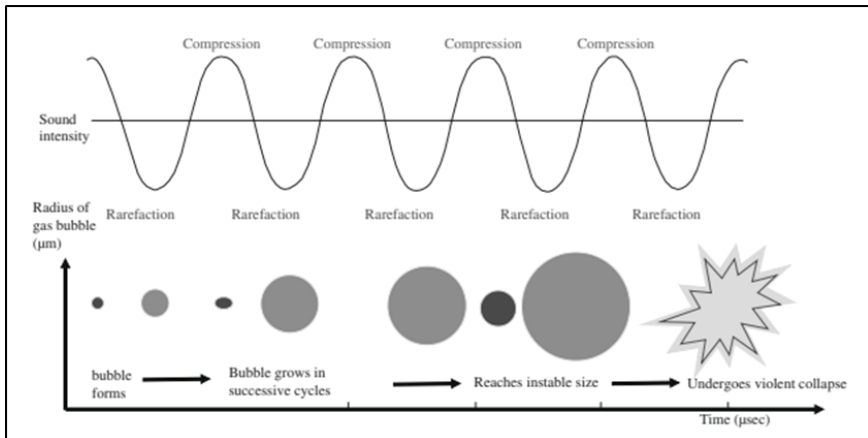

Figure 3. Formation and collapse press of a cavity (Le et al., 2015).

Cavitation can also be induced in waste sludge solution by exposing the liquid to velocity variations with the help of some specific narrowing structures, such as a venturi, orifice plate, or throttling valve. This phenomenon which is called as hydrodynamic cavitation, also attract academic and industrial interest in wastewater treatment fields. In the study conducted by Dindar et al. (2018), the efficiency of an orifice plate hydrodynamic cavitator for the mechanical disintegration of waste activated sludge was evaluated with soluble nitrogen and phosphorus parameters. The results showed that the sludge solubility was higher under the conditions where the cavitation number was 0.2 and the diameter of the orifice was 3 mm. It was determined that 47% and 50% of the TKN and TP in the sludge, respectively, were dissolved after 150 minutes of

cavitation time. In another study performed by Mancuso et al. (2022), it was determined that the dissolved COD content in sludges treated with hydrodynamic cavitation increased from 244 to 4.578 mg/L. In addition, it was understood from the dynamic light scattering analyzes and stereoscopic microscope examinations that the applied pretreatment method could lead to an apparent reduction in the size of the particles in the sludge.

Electrokinetic disintegration is another mechanical sludge pretreatment method that disrupts the floc structure of the sludge, breaks down the cell membrane and converts complex organic compounds into soluble forms by the effect of high voltage pulsed electric fields (20 kV to 30 kV). Peptidoglycans and phospholipids are polar molecules with negatively charged ligand groups. They are the construction bodies of cell walls and cell membranes (Seltmann and Holst, 2002) and are very sensitive to the electric field created by electrokinetic disintegration. A recent study investigated the effectiveness of the electrokinetic method in sludge disintegration using a laboratory scale pulsed electric field reactor. The tested disintegration practice enhanced the solubility of the sludge and increased the SCOD content 2.82 times in comparison with raw sludge. The electrokinetic pretreatment also improved the anaerobic digestion performance and increased the methane production 1.70 times (Selçuk-Kuşçu et al., 2022). In another similar study, it was determined that the SCOD value in the electrokinetically treated waste sludge increased by 220% compared to the raw sludge, and there was a corresponding increase in methane production (Lee and Ritmann, 2011).

Thermal disintegration is another efficient pretreatment method that has been broadly studied to improve the anaerobic digestion of sludge. Thermal disintegration methods, which are carried out in a wide temperature range between 60 and 270°C, consume more energy than mechanical methods. The methods performed at <100°C and >100°C are characterized as low-temperature thermal disintegration and high-temperature thermal disintegration processes, respectively. It has been emphasized in many studies that bacterial cells are effectively disintegrated and cellular components are released with the help of the heat applied to the waste sludge. In a research by Jeong et al. (2019), the success of thermal pretreatment as a sludge disintegration method was assessed at different temperature regimes ranging from 100 to 220°C. The obtained results show that the applied method increases sludge solubility and methane production. According to the BMP test results, the methane production in sludge pretreated by thermal method at 180°C is 313–348 L CH₄/kg VS. In another study, it was found that low temperature heat treatment (LT, 80°C) and high temperature heat treatment (HT, 170°C) increased the cumulative methane yield by 95% and 112%, respectively, compared to the control

(Zhang et al., 2019). With thermal pretreatment, the physicochemical properties of the sludge change, anaerobic digestion performance and subsequently biogas production increase significantly. However, there is still a need for studies to reduce the problems of thermal systems such as high capital cost, energy usage intensity, need for special reactors, formation of refractory compounds and ammonia toxicity by considering them holistically (Gahlot et al., 2022). Microwave-based pretreatment is an alternative technique to well-known thermal disintegration. This method distributes the energy in the form of heat and accomplishes microbial cell lysis and deterioration of sludge flocs. Lemmer et al. (2017) notified that the anaerobic digestion activity of sludge can be improved and the biogas yield can be increased by microwave pretreatment. As a result of the study, it was emphasized that lower energy pretreatments ($100\text{-}170\text{ kJ L}^{-1}$) performed at higher degree of microwave power (536 to 700W) are suitable for sludge disintegration. In another study examining the effectiveness of microwave pretreatment in sludge disintegration, it was specified that the sludge volume could be reduced by 60% with the effect of the applied process (Fang et al., 2017).

Biological Disintegration Methods

Biological disintegration methods (aerobic anaerobic, enzyme-added methods), which are accepted as environmentally friendly methods since no chemicals are used and do not create any toxic wastes, draw attention in the field of environmental technologies. Pre-aeration is a biological pretreatment method that accelerates hydrolysis, the rate-limiting stage of anaerobic digestion, by increasing the decomposition capacity of endogenous hydrolytic microbial communities (Bremond et al., 2018). This proceeding is also called “autohydrolysis” as the native hydrolysis potential of the sludge is used. Ahn et al. (2014) carried out a research to identify the effect of pre-aeration on the conversion of particulate matter in sludge into soluble forms and on digestibility of waste sludge. The outcomes of the study showed that the pre-aeration process applied before anaerobic digestion accelerated the growth of methanogens and positively affected the methane yield. While the cumulative methane yield of the raw sewage sludge was found to be $81.3\text{ mL CH}_4/\text{g VS}$, it was determined that this value increased by approximately 20% after 24 hours of pre-aeration. In a similar study conducted by Carvajal et al., (2013), the effects of autohydrolysis lasting 12 hours on sludge properties and anaerobic digestion performance were evaluated. It was determined that the pretreatment applied to the sludge increased the soluble COD content by 39%. In addition, up to 23% increase in methane production was noticed. Another application for pre-aeration is the infusion of a limited amount of air/oxygen into the reactor during anaerobic digestion process. In the method which is called as

micro-aeration, aerobic and anaerobic activities occurs in the same place. In a study examining the performance of the microaeration process and its effect on anaerobic digestion, a series of experiments were conducted to determine optimum microaeration levels and operating times. The study results pointed that the maximum methane yield was obtained at 0.35 air volume/min reactor volume conditions. The methane yield in the sludge with the micro-aeration process was 114% higher than that in the untreated raw sludge (Montalvo et al., 2016).

Another biological approach that accelerates the hydrolysis step in the anaerobic digestion process is to use a thermophilic/hyperthermophilic digester connected in series to a mesophilic one. The first anaerobic bioreactor in the two-stage system is the pretreatment stage and is designed to support the hydrolysis and acidogenesis stages of anaerobic digestion (Gonzales et al., 2018). Bolzonella et al. (2012) compared a two stage anaerobic digestion system (65°C + 55°C) with one-stage mesophilic (35°C) and one-stage thermophilic (55°C) digestion systems. The conclusions of the study showed that the COD removal in mesophilic, thermophilic and two-stage processes was 35%, 45% and 55%, respectively. The specific biogas (methane) generation was also apparently higher in the two-stage anaerobic digestion process. Another study showed that two-stage anaerobic digestion with suitable SRT in the thermophilic stage is highly effective in removing pathogens from sludge. *E. coli*, *Salmonella sp.* and *Shigella sp.* found in waste sludge were completely eliminated when the SRT of the thermophilic stage was greater than 2, 2 and 3d, respectively (Fu et al., 2014)

The use of enzymes that act as biocatalysts to increase anaerobic digestion performance is an alternative biological pretreatment method. With the addition of hydrolytic enzymes to the waste sludge as a pre-treatment process, the solubility of the sludge increases, the EPS structure deteriorates and the biogas production increases. Since waste activated sludge is primarily composed of proteins, carbohydrates and lipids, the main enzymes used in an enzyme assisted disintegration method are a proteases, carbohydrases and lipases (Meegoda et al, 2018). Chen et al, 2018 evaluate the protease, lysozyme and α -amylase additions to improve the biodegradability of excess sludge. It is indicated that lysozyme was more efficient in improving sludge hydrolysis and the dissolution of extracellular polymeric substances. The net increase in SCOD in the lysozyme containing reactor was 2.23 and 2.15 times greater than the increase in the protease and α -amylase containing reactors, respectively. In another study, the potential of the enzyme assisted disintegration method on the anaerobic digestibility of pulp and paper sludge was studied. The results of the BMP tests showed that the protease from *B. licheniformis*

gave the best results (26% increase) in terms of biogas efficiency (Bonilla et al., 2018). Wan et al. (2022) compared the effectiveness of using free and immobilized enzymes as a sludge disintegration method. The results showed that immobilized enzymes at a concentration of 1,000 mg/L provide a more effective disintegration than similar amounts of free enzymes.

Combined (Hybrid) Disintegration Methods

Although sludge disintegration methods are applied individually in most cases, the application of some different methods in combination has gained high popularity as it gives better results in terms of sludge hydrolysis and methane efficiency. It has been also reported that the limitations of individual disintegration methods such as high energy consumption, high capital, and high operating costs can be eliminated or decreased with hybrid applications created by combining two or more single processes (Atelge et al., 2020). For instance, according to a study conducted by Elalami et al. (2019), when the alkaline disintegration method was combined with thermal pretreatment, a synergistic effect occurred and the energy requirements of the system and the amount of alkaline reagent used were reduced.

In a research by Babu et al. (2021), the effects of different sludge disintegration methods (chemical, ultrasonication, thermal and combined methods) on the solubility of waste sludge were evaluated. The findings of the study indicated that the most efficient pretreatment method to hydrolyze the sludge is the combined method of alkaline and thermal applications under the conditions of pH 12 and 75°C. Soluble COD, total nitrogen, carbohydrates, and proteins in the sludge disintegrated by the combined method were found to be 5235, 430, 732 and 2688 mg/L, respectively. In another study, dewatered sludge was disintegrated using different concentrations of titania nanoparticles and sodium hydroxide. The results of the study revealed that generation of methane increased by 71.1% with alkaline+photocatalytic pretreatment applied as 0.5 g/L TiO₂ and 0.4% NaOH (Zeshan et al., 2021). Skorkowski et al. (2018) conducted a study to contrast the impacts of sludge disintegration methods of mechanical disintegration, ultrasonic disintegration and combined (hybrid) technique. According to the results obtained, the effectiveness of the hybrid process, which is specified as the increase of the degradation products per unit energy, was quite high compared to a single-stage process.

In another study, electrochemical treatment method (a pair of Fe-Fe electrode, electrolyte solution: Na₂SO₄) was used together with various chemicals (calcium hypochlorite, hydrogen peroxide, peroxymonosulfate and peroxydisulfate) and the performances of these hybrid methods in terms of sludge disintegration were compared. According to the results

of the study, the system in which electrochemical treatment was used together with hydrogen peroxide gave the best results with respect to disintegration of waste activated sludge. It was also determined that the ideal integrated method facilitating the dewatering properties of the sludge was electrochemical treatment + peroxydisulfate addition (Sari-Erkan and Onkal-Engin, 2020).

Conclusion

With the increase in the world population and the number of wastewater treatment facilities, the amount of released excess sludge is increasing day by day in all over the world. Managing these huge amounts of wastes is recognized as one of the most challenging issues in the area of environmental technology. Anaerobic digestion is the most widespread method used for sludge stabilization. The main benefit of anaerobic digestion is to stabilize the sludge into a harmless and easily dewaterable substance. In addition, with this method, methane-rich biogas, which can be used as an alternative energy source is released and the amount of sludge that needs to be disposed of is reduced. Therefore, great efforts are being made to improve the anaerobic digestion process, minimize sludge amounts and increase digested sludge quality.

In this review, various sludge disintegration methods applied to improve anaerobic digestion performance by increasing sludge hydrolysis were evaluated and current studies were discussed. Almost all of the sludge disintegration methods presented here demonstrate the ability to dissolve particulate matter and complex substances in waste sludge. The effects of these pretreatment methods applied under optimum conditions increase the biological degradation of the sludge, accelerate the hydrolysis phase in the anaerobic digestion process, boost the biogas production yield and decrease the amount of sludge that needs to be disposed of after anaerobic digestion. However, despite all these positive effects, each disintegration method has its own disadvantage such as high operating costs, high energy use, intense chemical use, and the potential to form some refractory or inhibitory intermediates. On the other hand, according to existing literature, combined systems can offer some advantages over individual disintegration systems. However, in order to maximize the positive effects of combined disintegration methods, it should be taken into account that choosing methods that can trigger synergistic effects and determining optimum operating conditions are of great importance.

REFERENCES

- Ahn, J. Y. & Chang, S. W. (2021). Effects of sludge concentration and disintegration/solubilization pretreatment methods on increasing anaerobic biodegradation efficiency and biogas production. *Sustainability*, 13(22), 12887. doi:10.3390/su132212887.
- Ahn, Y. M., Wi, J., Park, J. K., Higuchi, S. & Lee, N. H. (2014). Effects of pre-aeration on the anaerobic digestion of sewage sludge. *Environmental Engineering Research*, 19(1), 59-66. doi:10.4491/eer.2014.19.1.059.
- Atelge, M.R.,Atabani, A.E., Banu, J.R., Krisa, D., Kaya, M., Eskicioglu, C., Kumar, G., Lee, C., Yildiz, Y.S. & Unalan, S. (2020). A critical review of pretreatment technologies to enhance anaerobic digestion and energy recovery. *Fuel*, 270, 117494.
- Babu, R., Capannelli, G. & Comite, A. (2021). Effect of different pretreatments on sludge solubilization and estimation of bioenergy potential. *Processes*, 9, 1382. doi:10.3390/pr9081382.
- Bolzonella, D., Cavinato, C., Fatone, F., Pavan, P. & Cecchi, F. (2012). High rate mesophilic, thermophilic, and temperature phased anaerobic digestion of waste activated sludge: A pilot scale study. *Waste Manag.*, 32(6),1196-201. doi:10.1016/j.wasman.2012.01.006.
- Bonilla, S., Choolaei, Z., Meyer, T., Edwards, E. A., Yakunin, A.F. & Allen, D. G. (2018). Evaluating the effect of enzymatic pretreatment on the anaerobic digestibility of pulp and paper biosludge. *Biotechnology Reports*, 17, 77-85, doi:10.1016/j.btre.2017.12.009.
- Brémond, U., de Buyer, R., Steyer, J.-P., Bernet, N. & Carrere, H. (2018). Biological pretreatments of biomass for improving biogas production: An overview from lab scale to full-scale. *Renew. Sustain. Energy Rev.*, 90, 583–604. doi:10.1016/j.rser.2018.03.103.
- Carvajal, A., Peña, M. & Pérez-Elvira, S. (2013). Autohydrolysis pretreatment of secondary sludge for anaerobic digestion. *Biochem. Eng. J.*, 75, 21–31.
- Chen, J., Liu, S., Wang, Y., Huang, W. & Zhou, J. (2018). Effect of different hydrolytic enzymes pretreatment for improving the hydrolysis and biodegradability of waste activated sludge. *Water Sci Technol*, 2, 592-602. doi:10.2166/wst.2018.185.
- Chiavola, A., D'Amato, E. & Boni, M.R. (2019). Effects of low-dosage ozone pre-treatment on the anaerobic digestion of secondary and mixed sludge. *Environ. Sci. Pollut. Res. Int.*, 26, 35957–35967. doi: 10.1007/s11356-019-06684-9.
- Dahou, M. E. A., Hadj Kouider, M., Dehmani, S., Habchi, A. & Slimani, S. (2022). Experimental study of increase of biogas production from lagoon station's sludge by alkaline pretreatment. *Energy & Environment*, 0(0). doi:10.1177/0958305X221088569.

- de Sousa, T. A. T., do Monte, F. P., do Nascimento Silva, J. V., Lopes, W. S., Leite, V. D., van Lier, J. B. & de Sousa, J. T. (2021). Alkaline and acid solubilisation of waste activated sludge. *Water Sci Technol.*, 83(12), 2980–2996. doi:10.2166/wst.2021.179.
- Dindar, E., Topac-Sagban, F. O. & Etyam, C. (2018). Variations of dissolved nitrogen and phosphorus levels in disintegration of active sludge using hydrodynamic cavitation. *Journal of the Faculty of Engineering and Architecture of Gazi University*, 33(3), 1145–1153. doi:10.17341/gazimmfd.416416.
- Elalami, D., Carrere, H., Monlau, F., Abdelouahdi, K., Oukarroum, A. & Barakat, A. (2019). Pretreatment and co-digestion of wastewater sludge for biogas production: Recent research advances and trends. *Renew. Sustain. Energy Rev.*, 114, 109287.
- Ennouri, H., Miladi, B., Diaz, S.Z., Güelfo, L.A.F., Solera, R., Hamdi, M. & Bouallagui, H. (2016). Effect of thermal pretreatment on the biogas production and microbial communities balance during anaerobic digestion of urban and industrial waste activated sludge. *Bioresource Technology*, 214, 184–191. doi:10.1016/j.biortech.2016.04.076.
- Fang, G., Zhou, X., & Wei, W. (2017). Enhancing anaerobic biodegradability and dewaterability of sewage sludge by microwave irradiation. *International Journal of Agricultural and Biological Engineering*, 10(2), 224-232.
- Feki, E., Battimelli, A., Sayadi, S., Dhoub, A. & Khoufi, S. (2020). High-rate anaerobic digestion of waste activated sludge by integration of electro-fenton process. *Molecules*, 25(3), 626. doi:10.3390/molecules25030626.
- Fu, B., Wang, Y., Liu, H., Chen, Y., Jiang, Q. & Liu, H. (2014). Balancing energy production and pathogen removal during temperature phased anaerobic digestion of sewage sludge. *Fresenius Environ. Bull.*, 23, 1643–1649.
- Gahlot, P., Balasundaram, G., Vinay, K.T., Atabani, A.E., Suthar, S., Kazmi, A. A., Štěpanec, L., Juchelková, D. & Kumar, A. (2022). Principles and potential of thermal hydrolysis of sewage sludge to enhance anaerobic digestion. *Environmental Research*, 214, 2, 113856. doi:10.1016/j.envres.2022.113856.
- Gonzales, A., Hendriks, A., van Lier, J.B. & de Kreuk, M. (2018). Pre-treatments to enhance the biodegradability of waste activated sludge: Elucidating the rate limiting step. *Biotechnol. Adv.*, 36, 1434–1469. doi:10.1016/j.biotechadv.2018.06.001.
- Hanum, F., Yuan, L.C., Kamahara, H., Aziz, H. A., Atsuta, Y., Yamada, T. & Daimon, H. (2019). Treatment of sewage sludge using anaerobic digestion in Malaysia: Current state and challenges. *Front. Energy Res., Sec. Bioenergy and Biofuels*, 7, 19. doi:10.3389/fenrg.2019.00019
- He, H., Xin, X., Qiu, W., Li, D., Liu, Z. & Ma, J. (2021). Waste sludge disintegration, methanogenesis and final disposal via various pretreatments: Comparison of performance and effectiveness. *Environ Sci Ecotechnol.*, 8, 100132. doi: 10.1016/j.esec.2021.100132.

- Hodaei, M., Ghasemi, S., Khosravi, A. & Vossoughi, M. (2021). Effect of the ozonation pretreatment on biogas production from waste activated sludge of Tehran wastewater treatment plant. *Biomass and Bioenergy*, 152, 106198. doi:10.1016/j.biombioe.2021.106198.
- Iglesias, R., Muñoz, R., Polanco, M., Díaz, I., Susmozas, A., Moreno, A.D., Guirado, M., Carreras, N. & Ballesteros, M. (2021). Biogas from Anaerobic Digestion as an Energy Vector: Current Upgrading Development. *Energies*, 14(10), 2742. doi:10.3390/en14102742.
- Janesch, E., Pereira, J., Neubauer, P. & Junne, S. (2021). Phase separation in anaerobic digestion: A potential for easier process combination? *Frontiers in Chemical Engineering*, 3, 711971. doi:10.3389/fceng.2021.711971
- Jeong, S. Y., Chang, S. W., Ngo, H. H. Guo, W., Nghiem, L. D., Banu, J. R., Jeon, B. H. & Nguyen, D. D. (2019). Influence of thermal hydrolysis pretreatment on physicochemical properties and anaerobic biodegradability of waste activated sludge with different solids content. *Waste Management*, 85, 214-221, doi:10.1016/j.wasman.2018.12.026.
- Lee, I. S. & Rittmann, B. E. (2011). Effect of low solids retention time and focused pulsed pre-treatment on anaerobic digestion of waste activated sludge. *Bioresource Technol.*, 102, 2542-2548.
- Lemmer, B., Hodúr, C., & Beszédés, S. (2017). Continuously flow microwave pre-treatment for enhanced anaerobic biodegradability of dairy industry sludge. *International Journal of Environmental and Agriculture Research*, 3(6), 12–18. doi:10.25125/AGRICULTURE-JOURNAL-IJOEAR-JUN-2017-1.
- Li, H., Li, C., Liu, W. & Zou, S. (2012). Optimized alkaline pretreatment of sludge before anaerobic digestion. *Bioresource Technology*, 123, 189-194, doi:10.1016/j.biortech.2012.08.017.
- Mancuso, G., Langone, M., Di Maggio, R., Toscano, A. & Andreottola, G. (2022). Effect of hydrodynamic cavitation on flocs structure in sewage sludge to increase stabilization for efficient and safe reuse in agriculture. *Bioremediation Journal*, 26(1), 41-52. doi: 10.1080/10889868.2021.1900055.
- Maspolim, Y., Zhou, Y., Guo, C., Xiao, K. & Ng, W. J. (2015). The effect of PH on solubilization of organic matter and microbial community structures in sludge fermentation. *Bioresource Technology*, 190, 289–298. doi:10.1016/j.biortech.2015.04.087.
- Meegoda, J. N., Li, B., Patel, K., Wang, L.B. (2018). A review of the processes, parameters, and optimization of anaerobic digestion. *Int J Environ Res Public Health*, 15(10), 2224. doi: 10.3390/ijerph15102224.
- Mitraka, G. C., Kontogiannopoulos, K. N., Batsioulas, M., Baniyas, G. F. Zouboulis, A.I. & Kougiyas, P.G. (2022). A comprehensive review on pretreatment methods for enhanced biogas production from sewage sludge. *Energies*, 15, 6536. doi:10.3390/en15186536.

- Montalvo, S., Ojeda, F., Huiliñir, C., Guerrero, L., Borja, R. & Castillo, A. (2016). Performance evaluation of micro-aerobic hydrolysis of mixed sludge: Optimum aeration and effect on its biochemical methane potential. *Journal of Environmental Science and Health, Part A*, 51(14), 1269-1277. doi:10.1080/10934529.2016.1215195.
- Nava-Valente, N., Hernández-Aguilar, E., Alvarado-Lassman, A. & Méndez-Contreras, J. M. (2022). Effect of acid pretreatment on the anaerobic codigestion of sewage sludge, chicken litter, and sugarcane waste (SCW) for biogas production. *Bioenerg. Res.*, doi:10.1007/s12155-022-10533-y.
- Neumann, P., Pesante, S., Venegas, M. & Vidal, G. (2016). Developments in pre-treatment methods to improve anaerobic digestion of sewage sludge. *Rev. Environ. Sci. Bio/Technol.*, 15, 173–211. doi:10.1007/s11157-016-9396-8.
- Prajapati, K. K., Pareek, N. & Vivekanand V. (2018). Pretreatment and multi-feed anaerobic co-digestion of agro-industrial residual biomass for improved biomethanation and kinetic analysis. *Frontiers in Energy Research*, 6, 111, doi:10.3389/fenrg.2018.00111.
- Robson, J., Alessi, A., Bochiwal, C., O'Malley, C. & Chong, J. P. J. (2016). Biomethane as an energy source. In: Lee, S. (eds) *Consequences of Microbial Interactions with Hydrocarbons, Oils, and Lipids: Production of Fuels and Chemicals. Handbook of Hydrocarbon and Lipid Microbiology* Springer, Cham. https://doi.org/10.1007/978-3-319-31421-1_208-1.
- Roebuck, P., Kennedy, K. & Delatolla, R. (2019). Ultrasonic pretreatment for anaerobic digestion of suspended and attached growth sludges. *Water Quality Research Journal*, 54 (4), 265–277. doi:10.2166/wqrj.2019.039.
- Sari-Erkan, H. & Onkal-Engin, G. (2020). A comparative study of waste activated sludge disintegration by electrochemical pretreatment process combined with hydroxyl and sulfate radical based oxidants. *Journal of Environmental Chemical Engineering*, 8, 4, 103918, doi:10.1016/j.jece.2020.103918.
- Sari-Erkan, H. (2019). Waste activated sludge disintegration by hydroxyl and sulfate radical-based oxidation: A comparative study. *Environ. Sci.: Water Res. Technol.*, 5, 2027-2040. doi:10.1039/C9EW00663J.
- Selçuk-Kuşçu, Ö, Çömlekçi, S. & Çört, N. (2022). Disintegration of sewage sludge using pulsed electrical field technique: PEF optimization, simulation, and anaerobic digestion. *Environmental Technology*, 43,18, 2809-2824. doi: 10.1080/09593330.2021.1906324.
- Seltmann, G. & Holst, O. (2002). *The Bacterial Cell Wall*, Springer, Berlin/Heidelberg/Germany.
- Shrestha, B., Hernandez, R., Fortela, D.L.B., Sharp, W., Chistoserdov, A., Gang, D., Revellame, E., Holmes, W. & Zappi, M.E. (2020). A review of pre-treatment methods to enhance solids reduction during anaerobic digestion of municipal wastewater sludges and the resulting digester perfor-

- mance: Implications to future urban biorefineries. *Appl. Sci.*, 10(24), 9141. doi:10.3390/app10249141.
- Skórkowski, Ł., Zielewicz, E., Kawczyński, A. & Gil, B. (2018). Assessment of excess sludge ultrasonic, mechanical and hybrid pretreatment in relation to the energy parameters. *Water*, 10(5),551. doi:10.3390/w10050551.
- Sun, D. D., Liang, H. M., & Ma, C. (2012). Enhancement of sewage sludge anaerobic digestibility by sulfate radical pretreatment. *Advanced Materials Research*, 518–523, 3358–3362. doi:10.4028/www.scientific.net/amr.518-523.3358.
- Szypulska, D., Stanisław, M., Kamil, J., Mateusz, M.H., Bartosz, Z. & Grzegorz, C. (2021). Waste activated sludge disintegration with free nitrous acid – Comprehensive analysis of the process parameters. *Renewable Energy*, Elsevier, vol. 172(C), pages 112-120.
- Tyagi, V.K. & Lo, S.L. (2011). Application of physico-chemical pretreatment methods to enhance the sludge disintegration and subsequent anaerobic digestion: An up to date review. *Rev. Environ. Sci. Bio/Technol.*, 10, 215–242.
- Tyła, M. (2018). The effects of ultrasonic disintegration as a function of waste activated sludge characteristics and technical conditions of conducting the process-comprehensive analysis. *Int J Environ Res Public Health*, 15(10), 2311. doi:10.3390/ijerph15102311.
- Verma S. (2002). *Anaerobic Digestion of Biodegradable Organics in Municipal Solid Wastes*. Columbia University; New York, NY, USA
- Volschan Junior, I., de Almeida, R. & Cammarota, M.C. (2021). A review of sludge pretreatment methods and co-digestion to boost biogas production and energy self-sufficiency in wastewater treatment plants. *J. Water Process Eng.*, 40, 101857. doi:10.1016/j.jwpe.2020.101857.
- Wan, J., Zhang, L., Jia, B., Yang, B., Luo, Z., Yang, J., Boguta, P. & Su, X. (2022). Effects of enzymes on organic matter conversion in anaerobic fermentation of sludge to produce volatile fatty acids. *Bioresource Technology*, 366, 128227, doi:10.1016/j.biortech.2022.128227.
- Ward, A. J., Hobbs, P. J., Holliman, P. J. & Jones, D. L. (2008). Optimisation of the anaerobic digestion of agricultural resources. *Bioresource Technology*, 99, 7928-7940. doi:10.1016/j.biortech.2008.02.044.
- Wei, H., Gao, B., Ren, J., Li, A. & Yang, H. (2018). Coagulation/flocculation in dewatering of sludge: A review. *Water Research*, 143, 608–631. doi:10.1016/j.watres.2018.07.029.
- Xiao, R., Liu, K., Bai, L., Minakata, D., Seo, Y. Göktaş, R. K., Dionysiou, D. D., Tang, C. J., Wei, Z. & Spinney, R. (2019). Inactivation of pathogenic microorganisms by sulfate radical: Present and future. *Chemical Engineering Journal*, 371, 222-232, doi:10.1016/j.cej.2019.03.296.
- Zawieja, I. & Brzeska, K. (2019). Biogas production in the methane fermentation

of excess sludge oxidized with Fenton's reagent. ASEE19, E3S Web of Conferences 116, 00104. doi:10.1051/e3sconf/201911600104.

Zeshan, A. M., Badshah, M., Sabeeh, M. & Khan, S. J. (2021). Enhancing methane production from dewatered waste activated sludge through alkaline and photocatalytic pretreatment, *Bioresource Technology*, 325, 124677, doi:10.1016/j.biortech.2021.124677.

Zhang, Q., Hu, J. & Lee, D. J (2016). Biogas from anaerobic digestion processes: Research updates. *Renewable Energy*, 98, 108-119. doi:10.1016/j.renene.2016.02.029.

Zhang, W., Xiao, B., Li, Y., Liu, Y. and Guo, X. (2018). Effects of return sludge alkaline treatment on sludge reduction in laboratory-scale anaerobic-anoxic-oxic process. *J Biotechnol.*, 285,1-5. doi:10.1016/j.jbiotec.2018.08.018.

Zhang, Y., Xu, S., Cui, M. & Wong, J. W. C. (2019). Effects of different thermal pretreatments on the biodegradability and bioaccessibility of sewage sludge. *Waste Management*, 1(94), 68-76. doi: 10.1016/j.wasman.2019.05.047.

“

Chapter 23

RESONANCE IN ELECTRICAL CIRCUITS

Hilmi ZENK¹

”

¹ Doç. Dr., Mühendislik Fakültesi, Elektrik-Elektronik Mühendisliği Bölümü

A system under the action of a periodic force exhibits oscillations, and if the frequency of the action is equal to the natural frequency of the system, the amplitude of these oscillations tends to increase indefinitely. As a result, the system cannot maintain its integrity or state after a certain amplitude, and it disperses or breaks down. This situation is called resonance [1].

Resonant circuits are circuits obtained by connecting the coil and capacitor in series or parallel. In these circuits, a special situation arises when the inductive and capacitive reactances are equalized at a certain frequency of the AC voltage. This special case is when the circuit impedance is too small or too large. The frequency that causes this situation to occur is called the “resonant frequency” and its value depends on the size of the coil and capacitor in the circuit. The resonance frequency can be found by equating equations (1) and (2) [2].

Resonant circuits are used to control the operating frequencies of the transmitters and receivers of the radars and to tune the desired station frequencies in radio receivers [3].

The effect of inductive reactance in alternating current circuits can be eliminated by incorporating capacitive reactance into the circuit. The fact that the inductive and capacitive reactance values are equal creates a very special situation in the circuit. A circuit consisting of equal reactances behaves like a circuit consisting of only one resistor. This situation is called the resonance state of the circuit [4].

Expressions of inductive and capacitive reactance in alternating current circuits;

$$X_L = 2\pi fL \quad (1)$$

$$X_C = \frac{1}{2\pi fC} \quad (2)$$

is in the form.

1. Lossless Circuit

A lossless circuit is expressed by the case that the circuit consists of only one inductance and capacitance without a resistor element, as shown in Figure 1.

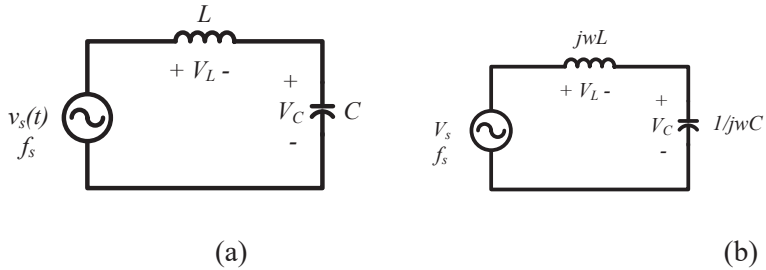

Figure 1. Lossless circuit (a) time-domain representation, (b) phasor-domain representation

The following relations can be written phasorically for the circuit under steady operating conditions.

$$V_s = IX_L - IX_C \quad (3)$$

In the above expression, the phase difference in the circuit is determined by the values of X_L and X_C . If the value of X_L is greater than X_C , the current I of the circuit will cause a phase difference 90° behind the voltage V_s , and if the value of X_L is less than the value of X_C , the current I of the circuit will cause a phase difference 90° ahead of the voltage V_s . The phasorial expressions for the inductive circuit where the X_L value is greater than the X_C value are as follows;

$$V_s = IX_L - IX_C \quad (4)$$

$$V_L = IX_L \quad (5)$$

$$V_C = IX_C \quad (6)$$

$$V_s = V_L - V_C \quad (7)$$

$$V_L = V_s - V_C \quad (8)$$

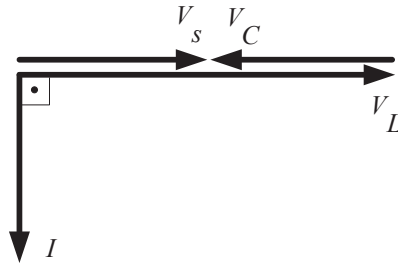

Figure 2. Phasor diagram of inductive lossless circuit

The phasorial expressions for the inductive circuit where the X_C value is greater than the X_L value are as follows;

$$V_s = IX_C - IX_L \quad (9)$$

$$V_s = V_C - V_L \quad (10)$$

$$-V_L = V_s - V_C \quad (11)$$

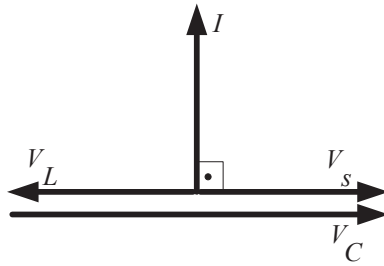

Figure 3. Phasor diagram of capacitive lossless circuit

If the circuit is inductive, as seen in Figure 4, the equilibrium point will be the intersection point indicated by a, while the equilibrium point will be the point indicated by b when our circuit is capacitive [5-10].

If $X_C = X_L$, the lines of these expressions do not intersect for the finite values of V and I in the circuit. This situation determines the series resonance condition. In series resonance, V and I values reach infinite magnitudes.

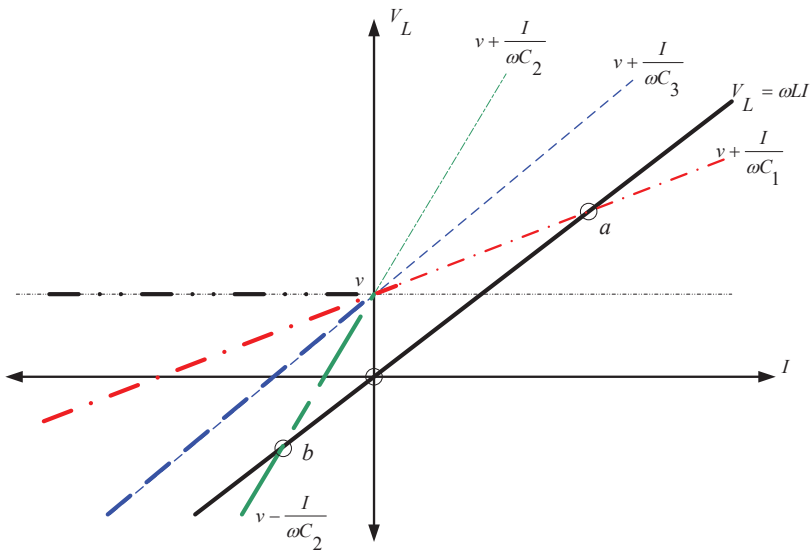

Figure 4. L,C circuit analysis

2. Lossy Circuit

In the case that there are resistors as well as capacitive and inductive elements in the circuit in addition to the lossless circuit, the circuit is defined as a lossy circuit. Lossy circuits are divided into two groups as series resonant circuit and parallel resonant circuit.

2.1. Series Resonant Circuit

The case where inductive reactance equals capacitive reactance in a lossy circuit is called series resonance or voltage resonance. A series resonant circuit is shown in Figure 5. When a direct voltage is applied to this circuit, after a certain time constant, since the capacitor will show an open-circuit characteristic at direct voltage, no current flows through the circuit and the source voltage V_s becomes equal to the capacitor voltage V_C .

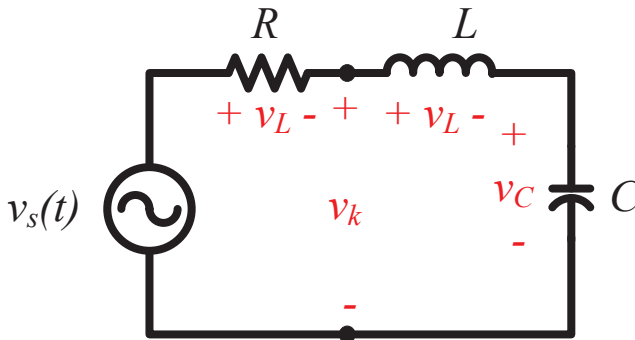

Figure 5. Time domain representation of a lossy circuit

Since alternating voltage is applied to the circuit, the current passing through the circuit; It varies according to the circuit elements, namely the resistance, the inductive reactance of the coil and the capacitive reactance of the capacitor. The vectorial sum of the resistances and reactances here gives the Z impedance of the circuit. Impedance; The total difficulty of pure resistance and reactance in an AC circuit.

In AC circuits using capacitors and coils, a phase difference occurs between current and voltage due to the voltage / current storage properties of these elements. Considering this point, the voltage drops in the series circuit are written as follows.

$$\vec{V}_s = \vec{V}_R + \vec{V}_C + \vec{V}_L \quad (12)$$

The reason for the vectorial summation of the voltage drops is the phase difference between the current and voltage occurring in the coil and the capacitor. So V_C and V_L are not in phase. Therefore, arithmetic addition is not possible. Since there is a phase difference between them, the total circuit voltage is found as a vector. Accordingly, the voltages are written as:

$$V_R = IR \quad (3.13)$$

$$V_L = IX_L \quad (3.14)$$

$$V_C = IX_C \quad (3.15)$$

The series RLC circuit has three types of operation: it is known as the resonant state ($X_L = X_C$), the over-resonant operating state ($X_L > X_C$), and the sub-resonant operating state ($X_C > X_L$).

2.1.1. Resonance State

When the reactances cancel each other's effect, the circuit shows the characteristics of a circuit consisting of only resistance. In case of resonance, the frequency of the voltage applied to the circuit is at a value that will provide the $X_C = X_L$ equation. When the reactances are equal, the voltage falling on the coil and the voltage falling on the capacitor are equal. However, since there is 180° phase difference between V_L and V_C voltages, they cancel each other out. In this case, the total resistance of the circuit is equal to R and the circuit voltage is equal to V_R and the circuit operates as a resistor. In these conditions, since the circuit impedance is minimum, the current passing through the circuit is at the maximum level. One of the important features of the series resonance circuit is that the current passing through the series circuit reaches the highest level. The frequency value that satisfies this equation is called the resonant frequency and is denoted by f_r . In the case of resonance, we can write the following expressions.

$$X_L = X_C \quad (16)$$

$$\frac{1}{\omega C} = \omega L \quad (17)$$

$$2\pi fL = \frac{1}{2\pi fC} \quad (18)$$

$$f_r = \frac{1}{2\pi\sqrt{LC}} \quad (19)$$

obtained. In cases where the resonant frequency is known, the values of inductance and capacitance are written as follows.

$$L = \frac{1}{4\pi^2 f_r^2 C} \quad (20)$$

$$C = \frac{1}{4\pi^2 f_r^2 L} \quad (21)$$

$$Z = \sqrt{R^2 + (X_L - X_C)^2} \quad (22)$$

Equations (20) and (21) give the impedance value equation (22) in case of resonance. From this, the result is $Z=R$ under resonance conditions.

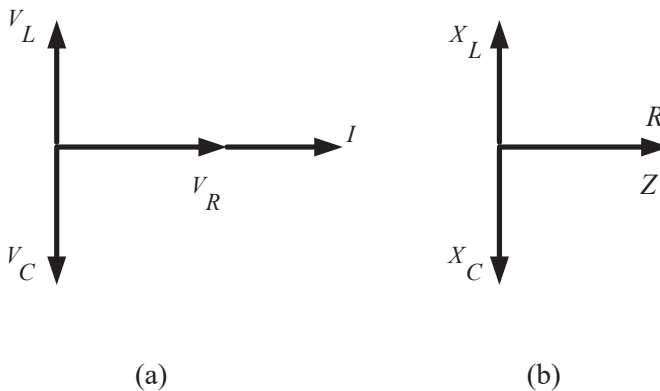

Figure 6. Resonance operation (a) voltage-current phasor diagram, (b) impedance phasor diagram

When the phasor diagram in Figure 6. is examined, it is seen that V_L and V_C are 180° opposite to each other and of equal amplitude, since a single current circulates in the series circuit and X_L is equal to X_C . Therefore, V_L and V_C will annihilate each other. Therefore, the circuit voltage will be equal to V_R . At the same time, the total impedance Z of the circuit becomes equal to the resistance R in the circuit. The current flowing through the circuit reaches its highest value.

2.1.2. Over Resonance Working Condition

When a frequency above the resonant frequency f_r is applied to the series resonant circuit, the inductive reactance X_L will increase in direct proportion to the frequency, while the capacitive reactance X_C will decrease inversely with the frequency.

$$X_L = 2\pi fL \quad (23)$$

$$X_C = \frac{1}{2\pi fC} \quad (24)$$

When equations (23) and (24) are examined, it will be seen that X_L will increase and X_C will decrease as f frequency increases. The circuit will gain an inductive effect due to the increase in X_L in over-resonant operation.

In other words, in case of $X_L > X_C$, the circuit becomes inductive. Vector diagrams related to this situation are given in Figure 7.

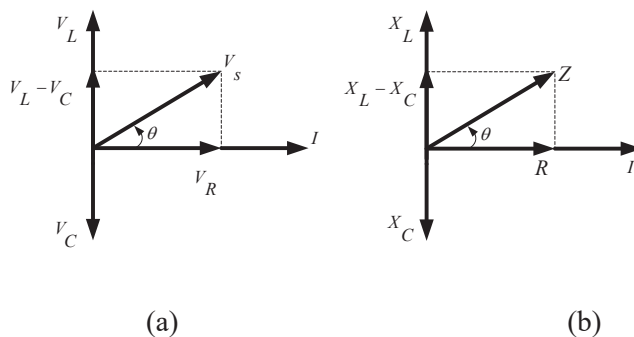

Figure 7. Over-resonance operation (a) voltage-current phasor diagram (b) impedance phasor diagram

Figure 7. Series RLC circuit voltage-current relations in (a), Figure 7. In (b), the series RLC circuit resistance reactance-impedance relations are given. where V_s is the total vector voltage of the circuit; Z represents the total impedance of the circuit. When the phasor diagrams are examined, the voltage and impedance equations are written as follows,

$$V_s^2 = V_R^2 + (V_L - V_C)^2 \quad (25)$$

$$V_s = \sqrt{V_R^2 + (V_L - V_C)^2} \quad (26)$$

Figure 6. When the phasor diagram in (a) is examined, it is seen that the voltage U makes an angle with the horizontal axis. This angle is called the phase angle of the circuit and is denoted by θ . The phase angle is expressed as:

$$\theta = \tan^{-1} \left(\frac{V_L - V_C}{V_R} \right) \quad (27)$$

or Figure 6. When the phasor diagram in (b) is examined,

$$\theta = \tan^{-1} \left(\frac{X_L - X_C}{X_R} \right) \quad (28)$$

is found.

2.1.3. Sub-Resonance Working Condition

When a frequency below the resonant frequency f_r is applied to the series resonant circuit, the X_L inductive reactance will decrease in direct proportion to the frequency, while the capacitive reactance X_C will increase inversely with the frequency.

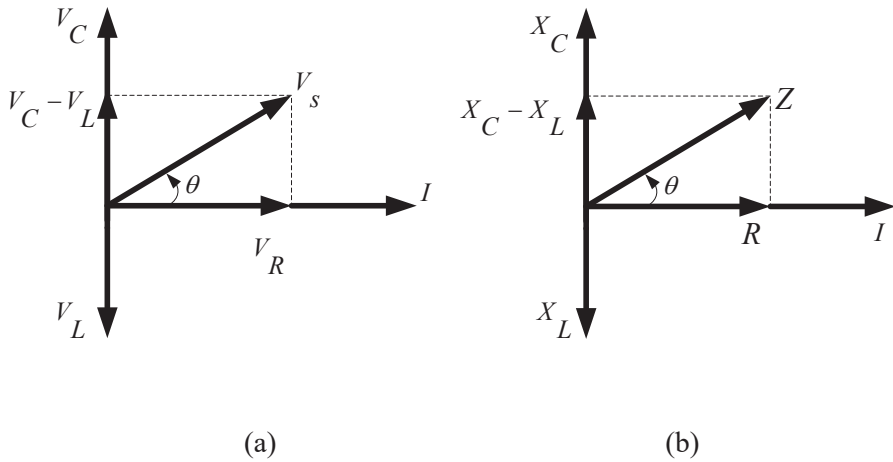

Figure 8. Sub-resonance operation (a) voltage-current phasor diagram (b) impedance phasor diagram

Due to the increase in X_C in sub-resonant operation, the circuit will gain a capacitive effect. In other words, in the case of $X_C > X_L$, the circuit becomes capacitive. Vector diagrams related to this situation are given in Figure 8. When the phasor diagrams are examined, the voltage and impedance equations are written as given in equations (29) and (30).

$$V_s^2 = V_R^2 + (V_C - V_L)^2 \tag{29}$$

$$V_s = \sqrt{V_R^2 + (V_C - V_L)^2} \tag{30}$$

Figure 8. When the phasor diagram in (a) is examined, it is seen that the voltage U makes an angle with the horizontal axis. This angle is called the phase angle of the circuit and is denoted by θ . The phase angle is expressed as:

$$\theta = \tan^{-1} \left(\frac{V_C - V_L}{V_R} \right) \tag{31}$$

or Figure 8. When the phasor diagram in (a) is examined,

$$\theta = \tan^{-1} \left(\frac{X_C - X_L}{X_R} \right) \quad (32)$$

is found.

The graph in Figure 9 shows the reactive and resistive responses of the series resonant circuit according to the frequency change. It is seen that as the frequency increases, X_C decreases exponentially, while X_L increases linearly, that is, the circuit is inductive. It is seen that X_C increases and X_L decreases as the resonance frequency is lowered, that is, the circuit is capacitive. At the resonant frequency, it is seen that $X_L = X_C$ and the circuit impedance is equal to R . In this case, the circuit is resistive. The current flowing through the circuit reaches its highest level.

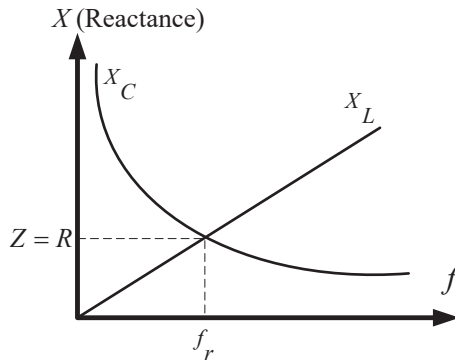

Figure 9. Series resonant circuit reactance-frequency graph

2.1.4. Series Resonant Circuit Bandwidth

Figure 10 shows the graph that gives the current voltage-impedance relationship of the series resonant circuit. In this graph, the points corresponding to 0.707 of the current curve are found based on the point where the current is maximum. These points are called half power points. When descending vertically from these points to the frequency axis, there are two frequencies such as f_1 and f_2 . The resonant frequency f_r lies in the middle of these points. The region between f_1 and f_2 gives the bandwidth (BW) of the circuit. In other words, the frequency band in which the current effectively passing through the series resonance circuit is valid. Bandwidth is used to determine the frequency limit at which a series or

parallel resonant circuit can be used effectively. Bandwidth is expressed mathematically as $BW = f_2 - f_1$. Half of this equation is taken to find the resonance frequency.

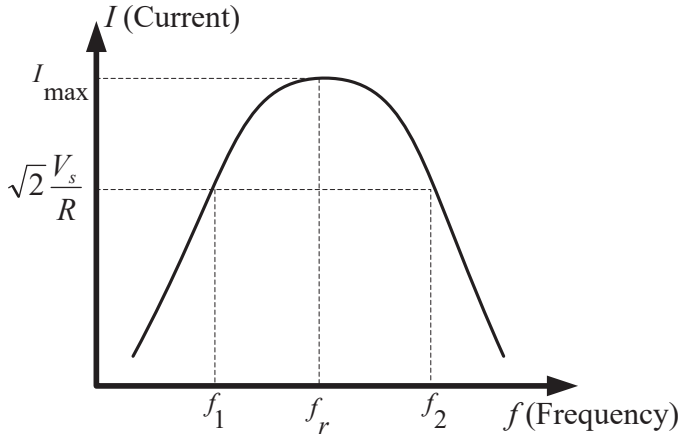

Figure 10. Series resonant circuit current-frequency graph

$$f_r = \frac{BW}{2} = \frac{f_1 - f_2}{2} \quad (3.33)$$

2.2. Parallel Resonance Circuit

Parallel resonant circuit is shown in Figure 11. The resonance condition in the series circuit is that the inductive reactance and capacitive reactance are equal to each other. Any RLC circuit comes into resonance when this condition is met. In a series circuit, there is only one branch through which the current can circulate. Therefore, the current is taken as constant. On the other hand, the voltage drops on the circuit are different and vary depending on the number of elements.

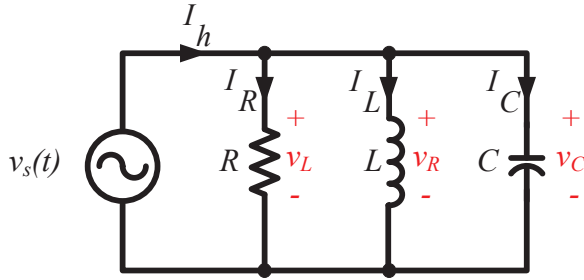

Figure 11. parallel resonant circuit

In parallel circuit, the voltage drops on the elements and the source voltage must be equal to each other. If the circuit current I_h is equal to the sum of the branch currents. The currents passing through the branches vary depending on the resistance R and reactances of the elements. In a parallel RLC circuit, the total circuit current is vectorized due to the phase difference.

$$\vec{I}_h = \vec{I}_R + \vec{I}_L + \vec{I}_C \quad (34)$$

$$I_h^2 = I_R^2 + (I_L - I_C)^2 \quad (35)$$

$$I_h^2 = I_R^2 + (I_C - I_L)^2 \quad (36)$$

The mathematical sign of inductive or capacitive reactances changes depending on whether the circuit is inductive or capacitive at frequencies below and above resonance. Here the impedance is,

$$\frac{1}{Z^2} = \frac{1}{R^2} + \left(\frac{1}{X_L} - \frac{1}{X_C} \right) \quad (37)$$

$$Z = \frac{1}{\sqrt{\frac{1}{R^2} + \left(\frac{1}{X_L} - \frac{1}{X_C} \right)}} \quad (38)$$

is found. Since the inductive reactance of the coil and the capacitive reactance of the capacitor will be equal at the moment of resonance, the currents passing through these arms will be equal to each other. The currents will also change according to the way of working under and over resonance. Finding the resonant frequency in a parallel circuit is the same as in a series resonant circuit. That is, the resonance frequency is found with the return (39).

$$f_{r_parallel} = f_{r_series} = f_r = \frac{1}{2\pi\sqrt{LC}} \quad (39)$$

As in the series resonant circuit, there are three modes of operation in the parallel resonant circuit. These are known as resonance condition $X_L=X_C$, above resonance operating condition $X_L>X_C$ and subresonance operating condition $X_C>X_L$.

2.2.1. Resonance State

In order for the parallel RLC circuit to resonate, the condition $X_L = X_C$ must be met. In this case, I_L and I_C currents passing through the coil and capacitor will be equal. There is a 180° phase difference between these currents. Therefore, these currents cancel each other out. As the reactive currents neutralize each other, the current passing through the circuit becomes only resistive I_R . In this case, the circuit becomes resistive, while the impedance equals the resistance in the circuit.

$$I_h = \frac{V}{R} \quad (30)$$

$$Z = \frac{V}{I_h} \quad (31)$$

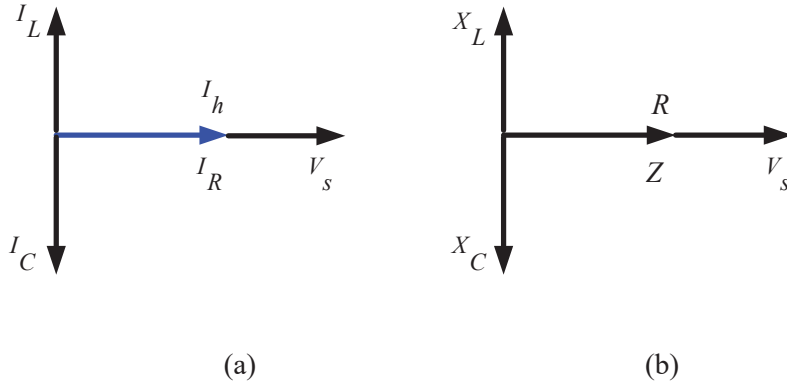

Figure 12. Resonance operation (a) current phasor diagram (b) impedance phasor diagram

As can be seen from the phasor diagrams, $X_L = X_C$ condition occurs when the parallel RLC circuit resonates. At this stage, since 180° phase difference occurs between them, their vector sum will be 0. The circuit impedance will only be equal to the resistance. Of the branch currents in the circuit, I_L and I_C are of equal magnitude and 180° opposite direction, and their vector sum will still be 0. Likewise, the current through the circuit will be $I_h = I_R$.

In a parallel RLC circuit, the minimum value of the circuit current at the time of resonance causes the circuit impedance to be maximum. Reaching the highest value of impedance is the most important and most useful feature of the parallel resonance circuit. This feature is used in the input circuits of radio receivers.

As it will be remembered from series resonant circuits, when the resonance frequency changes, the response of the circuit elements and changes in the circuit current will occur. The change in frequency has no effect on the current flowing through the resistive arm. For this reason, while explaining the studies at over-resonance and sub-resonance frequencies, the parallel LC circuit will be examined instead of the parallel RLC circuit. Parallel LC circuit is called tank circuit.

2.2.2. Over Resonance Working Condition

When the frequency f of the AC voltage applied to the parallel LC circuit shown in Figure 13 is increased, the inductive reactance of the coil increases in direct proportion to the frequency, and the capacitive reactance of the capacitor decreases exponentially. Therefore, while the current through the coil will decrease, the current through the capacitor will increase. In this case, $I_C > I_L$. As a result, the circuit becomes capacitive. Therefore, the line current I_h also increases in proportion to the value at the resonance moment.

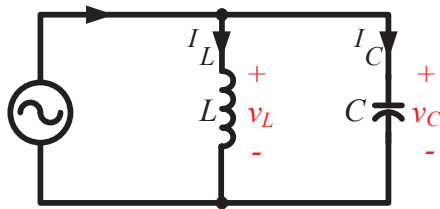

Figure 13. Parallel LC circuit above resonant operation circuit diagram

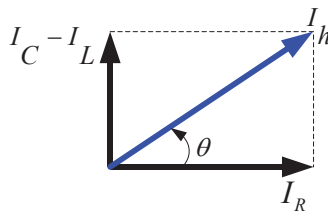

Figure 14. Vector diagram of parallel LC circuit over-resonant operating state currents

The angle between the line current and the resistor current in the vector diagram of the parallel LC circuit over-resonant operating state currents given in Figure 14 is the phase angle θ ;

$$\theta = \tan^{-1} \left(\frac{I_L - I_C}{I_R} \right) \quad (32)$$

is worth. The current changes occurring in the over-resonance operation are given graphically in Figure 15.

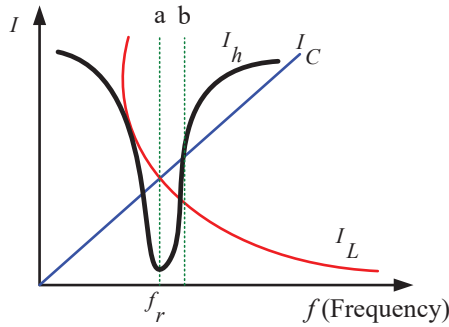

Figure 15. Parallel LC circuit over-resonant operation graph

2.2.3. Sub-Resonance Working Condition

It can be used in sub-resonant operation to the parallel LC circuit shown in Figure 13, but the only difference here is that the X_C value is greater than the X_L value. When the frequency of the AC voltage applied to the circuit is decreased, the inductive reactance of the coil decreases in direct proportion to the frequency, while the capacitive reactance of the capacitor increases. Therefore, while the current through the coil will increase, the current through the capacitor will decrease. In this case it would be $I_L > I_C$. Therefore, the circuit becomes inductive. Therefore, the line current I_h takes a higher value than its value at the time of resonance.

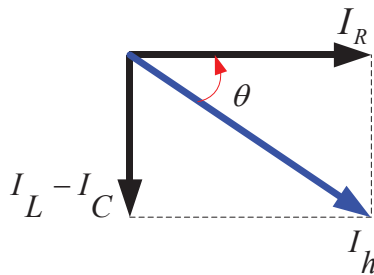

Figure 16. Vectorial diagram of parallel LC circuit sub-resonant operating state currents

The angle between the line current and the resistor current in the vector diagram of the parallel LC circuit over-resonant operating state currents given in Figure 16 is the phase angle θ ;

$$\theta = \tan^{-1} \left(\frac{I_C - I_L}{I_R} \right) \quad (33)$$

The graphical representation of the circuit currents in the sub-resonant operation of the parallel LC circuit is given in Figure 17. When the frequency of the AC energy applied to the parallel LC circuit is decreased, it will be seen that the line current of the I_L from the I_C is higher than the current value at the resonance moment.

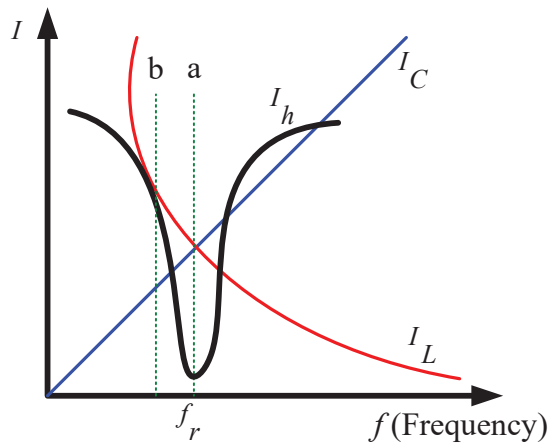

Figure 17. Parallel LC circuit sub-resonance operating graph

REFERENCES

- [1] Zenk, H. (2014). *Kapama açısının ferrerezonans olayına etkisi* (Doctoral dissertation, Karadeniz Teknik Üniversitesi).
- [2] Özer M., Akpınar S., Cebeci M., Kürüm H., *Başlangıç Koşullarının Ferrerezonans Olaylarına Etkileri*, Elektrik Mühendisliği 6. Ulusal Kongresi, Bursa, Eylül, 1995, Bildiriler Kitabı, 223-226.
- [3] Altuncu A., *Elektronik I Ders Notları*, Dumlupınar Üniversitesi, Kütahya, 2009.
- [4] Akpınar A. S., Altaş İ. H. ve Okumuş H. İ., *Temel Elektrik Laboratuvarı I Deney Föyü*, Elektrik Elektronik Müh. Böl., KTÜ.
- [5] Charles, K. A., & Matthew, N. O. (2017). *Fundamentals of electric circuits*.
- [6] McGraw-hill Education. Boylestad, R. L. (2013). *Introductory circuit analysis*. Pearson Education.
- [7] Irwin, J. D., & Nelms, R. M. (2020). *Basic engineering circuit analysis*. John Wiley & Sons.
- [8] Nahvi, M., & Edminister, J. A. (2018). *Schaum's outline of Electric Circuits*. McGraw-Hill Education.
- [9] Nilsson, J. W., & Riedel, S. A. (2020). *Electric circuits*. Pearson.
- [10] Salam, M. A., & Rahman, Q. M. (2018). *Fundamentals of electrical circuit analysis* (pp. 1-463). New York: Springer.

“

Chapter 24

**RECOMMENDATION OF EIGHT
ROTOR UAVS WITH DIFFERENT
CONFIGURATIONS AND COMPARISON
OF FLIGHT PERFORMANCES WITH
TWO DIFFERENT UAVS WITH
STANDARD CONFIGURATIONS UNDER
IMPACT FORCE**

Nihat ÇABUK¹

”

¹ Dr. Nihat ÇABUK, Aksaray University Vocational School of Technical Sciences, ORCID: 0000-0002-3668-7591

1. INTRODUCTION

Aircrafts can move in the air by creating a pressure difference thanks to the propeller systems that push the air. The earliest known work on flying can be said to be the "air screw" proposed by Leonardo da Vinci in the 15th century. However, it can be said that usable aircraft emerged at the beginning of the 20th century. As the 21st century approaches, these vehicles have become able to fly unmanned. Following this, unmanned aerial vehicles (UAV) have become one of the most popular work areas in recent years. The increase in the use of these tools day by day causes an increase in both production and academic studies in this field. In addition to being included in two basic classifications as fixed-wing and rotary-wing UAVs, it is also possible to come across models in which these two types are used together. The superiority of all three models over each other causes them to be preferred in different areas of use. In particular, fixed-wing ones can reach longer flight times and take-off weight due to their aerodynamic structure and higher mass/energy (g/w) ratio. Basically, for this reason, they are more preferred for military purposes. It can be said that multi-rotor UAVs, which can be expressed as rotary wing, have a wide range of usage areas because they have high maneuverability and do not need special runways for take-off and landing. Multi-rotor UAVs can be produced in different rotor numbers, mostly four-rotor, six-rotor and eight-rotor.

When academic studies on multi-rotor UAVs are examined, it is seen that studies have been conducted on both different designs (Çabuk and Yıldırım 2021; Fu et al. 2017; Yıldırım, Çabuk, and Bakırcıoğlu 2020) and different control methods (Brischetto, Ciano, and Ferro 2016; Oktay and Köse 2019; Quan, Cui, and Du 2021; Saeed et al. 2018; Tilki and Erüst 2020). Zabunov et al. (Zabunov and Mardirossian 2018), the twelve-rotor dodecaopter model they designed is based on the investigation of the thrust force obtained per electrical power applied to the rotors by placing the rotors upside down on the vertical axis. According to the results obtained in their study, they obtained a higher mass/power ratio in the model with the rotors placed in reverse. Badr et al. (Badr, Mehrez, and Kabeel 2019) in their design study, carried out a design in which the rotation axes of the rotors can be changed according to the coordinate system assigned to the body. They stated that they achieved a more stable flight by obtaining more degrees of freedom with this design, which was carried out in order to achieve more stable suspension performance. In studies on the control of vertically taking off and landing UAVs (Bangura and Mahony 2017; Miranda-Colorado, Aguilar, and Herrero-Brito 2018; Muliadi and Kusumoputro 2018), Muliadi and Kusumoputro have conducted a comparison of the altitude control of the quadrotor unmanned aerial vehicle with artificial neural networks and PID. According to the results

they obtained, it was seen that the artificial neural network-based controller gave better results than the PID controller. In their study examining the performance of coaxial rotor UAVs, Bondyra et al. (Bondyra et al. 2016) experimentally showed that the lower propeller in the coaxial arrangement generates lower thrust. However, they stated that there was less power requirement for lower thrust. Buzzatto et al. (Buzzatto and Liarokapis 2022) proposed a new design for coaxial rotor UAVs to work more efficiently. In their study, they showed that the total thrust changes when the distance between the coaxial rotors is changed.

In this study, control and simulation of three different models obtained with three different arrays of rotors of a multi-rotor drone system with 8 rotors were carried out. The advantages of different models obtained for the same number of rotors compared to each other were examined. The first of the models was obtained with equiangular placement of all rotors in a single layer (which is the standard octocopter), the second was obtained with the coaxial arrangement of the rotors in pairs (which is the standard CoaxQuad), and the third was obtained with the non-coaxial arrangement of the rotors and quadruple placement in two layers (Which is, recommended in this study).

While the most important advantage of the first model is that it can display a more stable flight performance with the thrust force created from eight different points, its disadvantageous aspect is that it has a larger out-to-out dimension than the second one. The second UAV model has a lifting force from four points and its biggest advantage is that it has less length from outside to outside. The aim of this study is to examine the feasibility of these two advantages in a single drone model. For this purpose, a third model has been proposed, which has eight points of thrust as in the first model and has less outside-to-out dimensions as in the second model. Simulation studies were carried out four times for each model, in the form of two different impact times of two different values of force.

The rest of the study consists of "Materials and Methods", where the principle of the UAV system is explained, "Design and Modeling", where the design and mathematical models of the proposed UAV are obtained, and "Simulation and Results", where simulations are performed according to the obtained mathematical models.

MATERIAL AND METHOD

A set of coordinate axes should be assigned to both the vehicle body and the ground in order to accurately determine the positions of the UAVs during their flight. The position relationship between these axes is established with the rotation matrix R_B^E .

$$\mathbf{R}_B^E = \begin{bmatrix} c\psi c\theta & c\psi s\theta s\varphi - c\varphi s\psi & c\varphi c\psi s\theta + s\varphi s\psi \\ c\theta s\psi & s\psi s\theta s\varphi + c\psi c\varphi & c\varphi s\psi s\theta - c\psi s\varphi \\ -s\theta & s\varphi c\theta & c\varphi c\theta \end{bmatrix} \quad (1)$$

Here, angles φ , θ and ψ are roll, pitch and yaw angles, respectively. As seen in Figure 1, multi-rotor UAVs have a 6-degree-of-freedom structure that includes both linear and angular movements. They perform all of these movements by changing the angular velocity of the rotors. The propeller in each rotor generates a thrust proportional to the square of the rotor's rotational speed.

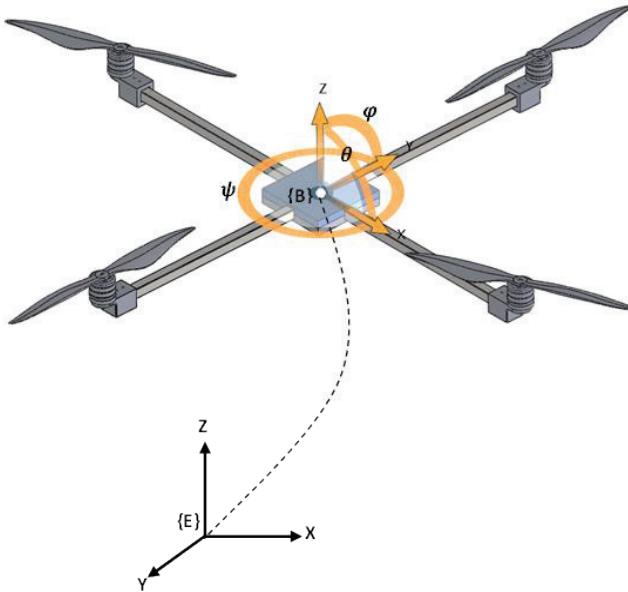

Figure 1. A quadrotor UAV structure

These forces allow the vehicle to move both angularly and linearly. In addition to the angular velocities of the rotors and the resulting moments and force, a \mathbf{C} matrix is created in which the physical structure of the vehicle is represented, such as the arm length to which the rotors are attached, the placement angles of the rotors. The relationship between them is given in equation 2.

$$\mathbf{U} = \mathbf{C} * \boldsymbol{\Omega} \quad (2)$$

In this equation, \mathbf{U} is the moments and force vector, and $\boldsymbol{\Omega}$ is the vector representing the squares of the angular velocities of the rotors, given in equations 3 and 4.

$$\boldsymbol{\Omega} = [\Omega_1^2 \quad \Omega_2^2 \quad \Omega_3^2 \quad \Omega_4^2 \quad \Omega_5^2 \quad \Omega_6^2 \quad \Omega_7^2 \quad \Omega_8^2]^T \quad (3)$$

$$\mathbf{U} = [F_T \quad M_\varphi \quad M_\theta \quad M_\psi]^T \quad (4)$$

Considering the obtained rotation matrix, the net force acting on the body of the vehicle is obtained as seen in Equation 5. In this equation, F_b is the force acting on the body of the vehicle and F_g is the gravitational force created by the effect of the vehicle's mass.

$$F_b = F_T - (R_B^E * F_g) \quad (5)$$

Considering the physical properties of the vehicle, both angular and linear non-linear motion equations are obtained as in equations 6 and 7.

$$\begin{aligned} \ddot{x} &= -\frac{F_T}{m} (s \varphi s \psi + c \varphi c \psi s \theta) \\ \ddot{y} &= -\frac{F_T}{m} (c \varphi s \psi s \varphi + c \psi s \varphi) \\ \ddot{z} &= g - \frac{F_T}{m} (c \varphi c \theta) \end{aligned} \quad (6)$$

$$\begin{aligned} \ddot{\varphi} &= \frac{M_\varphi}{I_{xx}} - \frac{J_r}{I_{xx}} \dot{\theta} \Omega + \frac{I_{yy}}{I_{xx}} \dot{\psi} \dot{\theta} - \frac{I_{zz}}{I_{xx}} \dot{\psi} \dot{\theta} \\ \ddot{\theta} &= \frac{M_\theta}{I_{yy}} - \frac{J_r}{I_{yy}} \dot{\varphi} \Omega + \frac{I_{zz}}{I_{yy}} \dot{\psi} \dot{\theta} - \frac{I_{xx}}{I_{yy}} \dot{\psi} \dot{\theta} \\ \ddot{\psi} &= \frac{M_\psi}{I_{yy}} + \frac{I_{zz}}{I_{zz}} \dot{\varphi} \dot{\theta} - \frac{I_{yy}}{I_{zz}} \dot{\varphi} \dot{\psi} \end{aligned} \quad (7)$$

Here, x , y , and z represent the position in the three axes, while M_φ , M_θ and M_ψ are the roll, pitch, and yaw moments, respectively. J_r is the inertia of the rotor-propeller pair, while I_{xx} , I_{yy} and I_{zz} are the inertia matrix elements of the vehicle. Besides, m represents the total mass of the vehicle and g represents the gravitational acceleration.

Although there are many control methods (Heidari and Saska 2021; Ucgun, Yuzgec, and Bayilmis 2021; Zheng et al. 2020) to obtain the control variables required to be obtained in the equations, the PID control method, which is one of the more traditional but highly effective control methods (Güçlü, Kurtuluş, and Arıkan 2016; Sen and Kalyoncu 2019; Shauqee, Rajendran, and Suhadis 2021), has been adopted in this study. The general principal diagram of the PID control method is given in Figure 2. Here, $r(t)$ and $y(t)$ are the response requested from the system, respectively, while the difference between these two is the error defined by $e(t) = r(t) - y(t)$. K_p , K_i and K_d are proportional, integral and derivative

constants, respectively, and the control signal $u(t)$ produced by the controller varies depending on the error of the system.

$$u(t) = K_p e(t) + K_i \int_0^t e(t) dt + K_d \frac{de(t)}{dt} \quad (8)$$

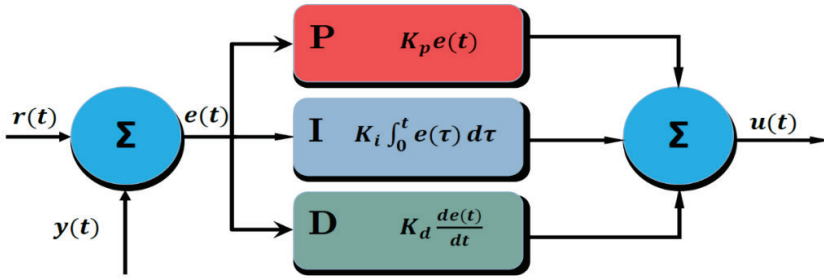

Figure 2. PID control block diagram

In PID control, proportional effect (P) reduces the rise time, but is not effective in eliminating the steady state error. The integral effect (I), also known as the reset effect, significantly reduces the steady state error. The differential effect (D), on the other hand, is expressed as forethought and can react quickly to error.

DESIGN AND MODELING

In this section, the structure of three different UAV configurations that will be examined within the scope of the study and the C matrices related to this structure, which were mentioned in the previous section, were obtained. This matrix consists of the thrust constant k_l , which relates the maximum thrust that each propeller can produce with the angular velocity of the propeller, similarly the reverse moment constant k_τ formed by the rotor-propeller pair, l , which is the length of the arm to which each rotor is connected, and the elements related to the arrangement of the rotors. Since the same propeller and motor were used in all three vehicles in the simulation studies, k_l and k_τ values were taken as the same. Other variables are specific to the created configuration. In the simulations, it is assumed that the bodies of the vehicles are rigid and the center of gravity is in the geometric center of the vehicle.

Table 1 Physical characteristics of UAV models

Vehicles	Physical Parameters				
	Arm length (l) [mm]	Thrust coefficient (k_t) [N/(rad/s) ²]	Torque coefficient (k_τ) [Nm/(rad/s) ²]	One propeller max thrust force [N]	Mass of UAV (m) [kg]
8X configuration	400	0.72×10^{-4}	1.92×10^{-6}	25	10
Coax Quad configuration	250	0.72×10^{-4}	1.92×10^{-6}	Upper:25 Lower:20	10
8X two-layer configuration (Proposed)	250	0.72×10^{-4}	1.92×10^{-6}	Upper:25 Lower:20	10

8X configuration

This configuration is a standard configuration and as seen in Figure 3, each propeller generates thrust from different points. The angle between the arms placed at equilateral angles is 45 degrees.

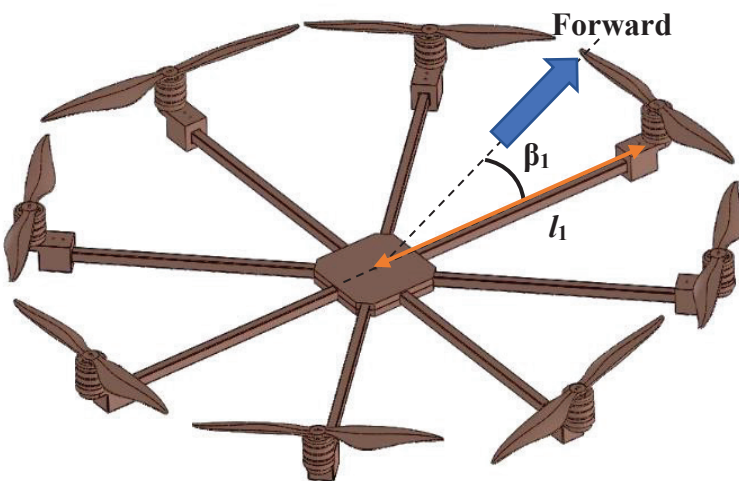

Figure 3. UAV with 8X configuration

The flight direction of the UAV is determined to be on the axis passing through the middle of the two arms, due to its X configuration.

According to this determined direction and other physical parameters, the configuration matrix \mathbf{C}_1 is obtained as given in equation 9. $\mathfrak{B}_1 = k_l l_1 \sin \beta_1$ and $\mathfrak{D}_1 = k_l l_1 \cos \beta_1$ are abbreviated to make the matrix simpler.

$$\mathbf{C}_1 = \begin{bmatrix} k_l & k_l & k_l & k_l & k_l & k_l & k_l & k_l \\ \mathfrak{B}_1 & -\mathfrak{B}_1 & \mathfrak{D}_1 & \mathfrak{B}_1 & -\mathfrak{B}_1 & -\mathfrak{D}_1 & -\mathfrak{D}_1 & \mathfrak{D}_1 \\ \mathfrak{D}_1 & -\mathfrak{B}_1 & \mathfrak{B}_1 & -\mathfrak{D}_1 & \mathfrak{D}_1 & -\mathfrak{B}_1 & \mathfrak{B}_1 & -\mathfrak{B}_1 \\ k_\tau & k_\tau & -k_\tau & -k_\tau & -k_\tau & -k_\tau & k_\tau & k_\tau \end{bmatrix} \quad (9)$$

CoaxQuad configuration

Eight-rotor UAVs with coaxial configuration are models where two rotors are attached to each arm. The biggest advantage of this structure is that more take-off weight is obtained with a smaller diameter UAV. However, the weakest aspect of this type of vehicle is that the propellers in the lower layer generate approximately 25% less thrust (Bondyra et al. 2016; Buzzatto and Liarokapis 2022). Although it needs less power despite its low thrust force, the fact that the motor could not operate at full efficiency can be expressed as a negative.

As seen in Figure 4, the rotors are placed in pairs on arms connected at equal angles. According to the X configuration, the direction of the vehicle is on the axis passing through the middle of the two arms. The angle between this axis and the arm is 45 degrees. The necessary configuration

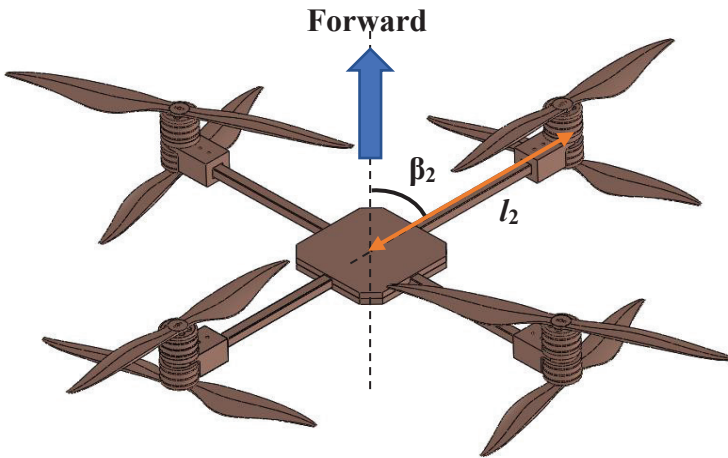

Figure 4. UAV with CoaxQuad configuration

matrix obtained for the simulation is given in equation 10. $\mathfrak{B}_2 = k_1 l_2 \sin \beta_2$ and $\mathfrak{D}_2 = k_1 l_2 \cos \beta_2$ have been abbreviated to make the matrix simpler.

$$C_2 = \begin{bmatrix} k_l & k_l & k_l & k_l & k_l & k_l & k_l & k_l \\ -\mathfrak{B}_2 & \mathfrak{B}_2 & \mathfrak{D}_2 & \mathfrak{B}_2 & -\mathfrak{B}_2 & -\mathfrak{D}_2 & -\mathfrak{D}_2 & \mathfrak{D}_2 \\ \mathfrak{D}_2 & -\mathfrak{B}_2 & \mathfrak{B}_2 & -\mathfrak{D}_2 & \mathfrak{D}_2 & -\mathfrak{B}_2 & \mathfrak{B}_2 & -\mathfrak{B}_2 \\ -k_\tau & k_\tau & -k_\tau & k_\tau & -k_\tau & k_\tau & -k_\tau & k_\tau \end{bmatrix} \quad (10)$$

Proposed (8X two layer) configuration

Above are the strengths and weaknesses of the two standard configurations. The strengths of these two configurations are both to create thrust from eight different points and to achieve a shorter diameter with this proposed configuration. In addition, it is aimed to reduce the thrust loss of the lower rotor in the coaxial configuration. Experimental work is required to determine this loss exactly. As seen in Figure 5, in this proposed configuration, four of the rotors are placed on the substrate. In this way, a shorter diameter structure such as coaxial is obtained, and all of the propellers provide thrust from different points.

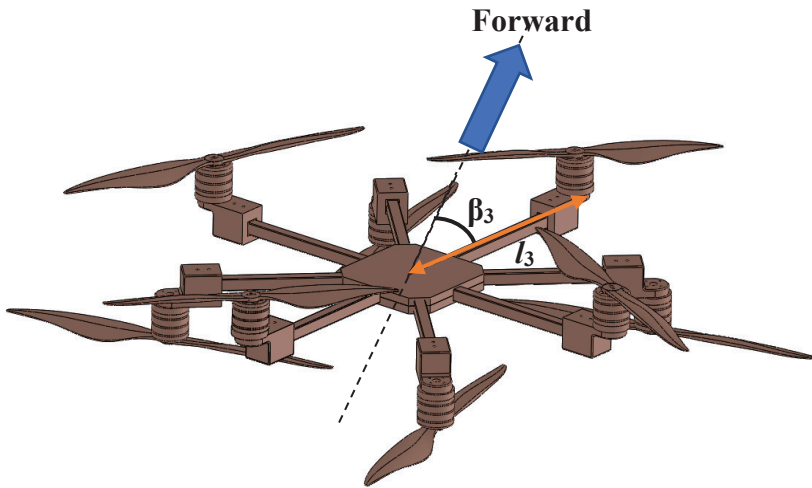

Figure 5. UAV with 8X two-layer configuration

As with the other two models, the direction of the vehicle is on the axis passing through the middle of the two arms due to the X configuration. The angle between this axis and the arm is 22.5 degrees. The necessary configuration matrix obtained for the simulation is given in equation 11.

$\mathfrak{B}_3 = k_l l_3 \sin \beta_3$ and $\mathfrak{D}_3 = k_l l_3 \cos \beta_3$ have been abbreviated to make the matrix simpler.

$$C_3 = \begin{bmatrix} k_l & k_l & k_l & k_l & k_l & k_l & k_l & k_l \\ -\mathfrak{B}_3 & \mathfrak{B}_3 & \mathfrak{D}_3 & \mathfrak{B}_3 & -\mathfrak{B}_3 & -\mathfrak{D}_3 & -\mathfrak{D}_3 & \mathfrak{D}_3 \\ \mathfrak{D}_3 & -\mathfrak{B}_3 & \mathfrak{B}_3 & -\mathfrak{D}_3 & \mathfrak{D}_3 & -\mathfrak{B}_3 & \mathfrak{B}_3 & -\mathfrak{B}_3 \\ k_\tau & k_\tau & -k_\tau & -k_\tau & -k_\tau & -k_\tau & k_\tau & k_\tau \end{bmatrix} \quad (11)$$

SIMULATION AND RESULTS

Simulation studies were carried out in four different situations, taking into account the different impact time of different disrupting impact forces. PID controller is preferred for the control of all three UAV systems. The block diagram of the whole system is given in Figure 6. According to the figure, after the forces and moments required for the desired position ($x_{des}, y_{des}, z_{des}$) are obtained from the controller, the angular velocities (Ω_{des}) required for the motors are calculated by inverse kinematics operation ($\Omega_{des} = inv(C) * U$).

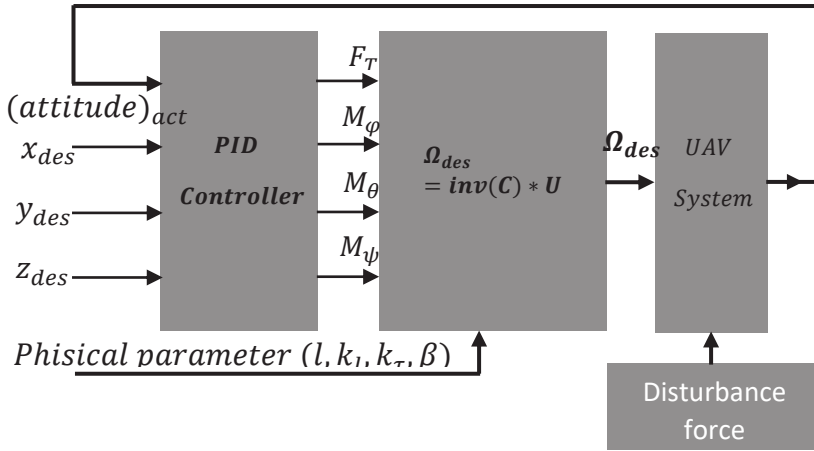

Figure 6. Whole system block diagram

As a result of these angular velocities, the response of the UAV system ($(attitude)_{act}$) is fed back to the controller and continuous control is provided. Here, the desired values are shown with the (*des*) index, while the actual values are shown with the (*act*) index. The PID controller structure, in which the necessary thrust force and moments are obtained in order to follow the desired trajectory with the PID controller, is shown in Figure 7.

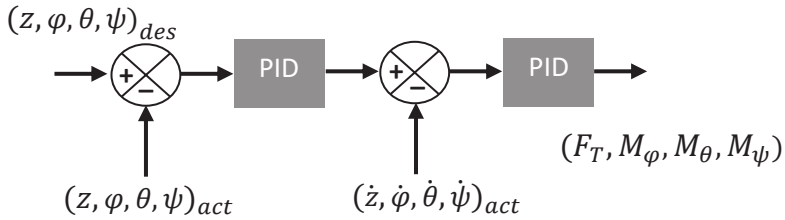

Figure 8. PID controller structure of the system

The disruptive impact forces applied to the UAVs are given in Figure 8. Four different simulations were carried out for each vehicle type by applying the impact force to the UAVs in two different times as 200 ms and 400 ms, and the intensity at two different values as 20 N and 25 N. The highest and lowest values of these forces were chosen so low that the vehicles would not get out of control and so high that the disruptive effect could be observed.

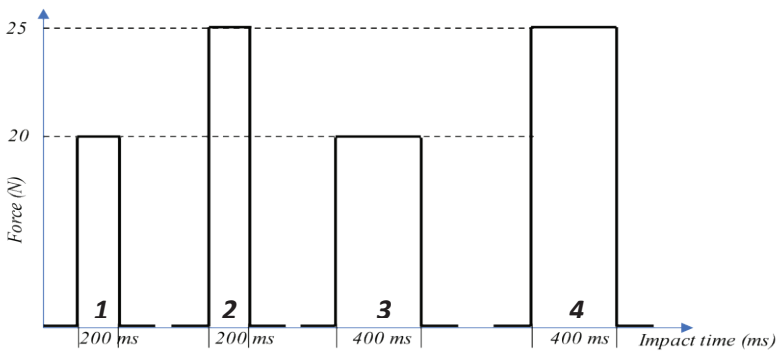

Figure 7. Four different impact forces applied

While this applied force creates a disruptive moment effect in the roll, pitch and yaw axes, it creates a disruptive effect on the thrust force in the vertical axis. These forces were applied at 4th, 8th and 12th seconds of the simulation. These are the times when UAVs take off, hovering and landing. Thus, the ability of UAVs to eliminate the disruptive force in three different movements has been examined. As a result of the simulations, the performances of the vehicles were examined by considering the position tracking in three axes. The duration of the simulations was determined as 15 seconds, and the graphical results are given in figures 9, 10 and 11 for each vehicle model separately.

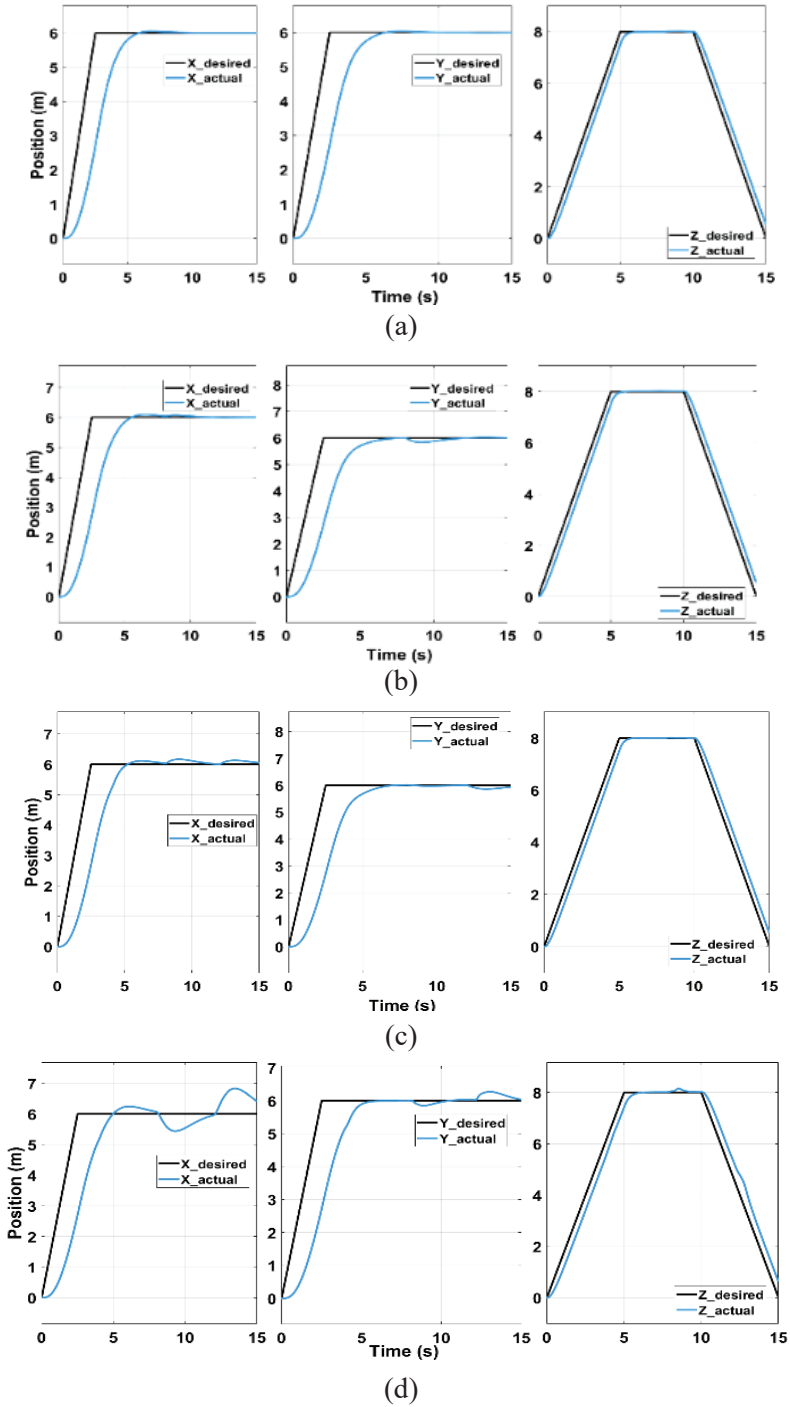
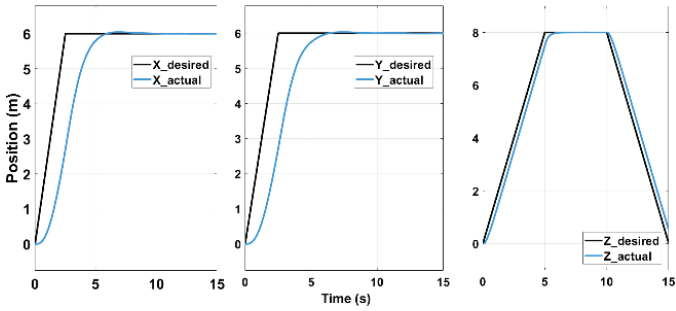
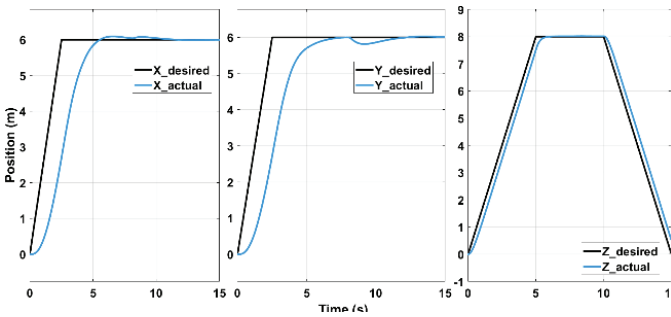

Figure 9. 8X configuration results. (a)-20N and 200 ms, (b)-20N and 400ms, (c)- 25N and 200 ms, (d)- 25N and 400 ms.



(a)



(b)

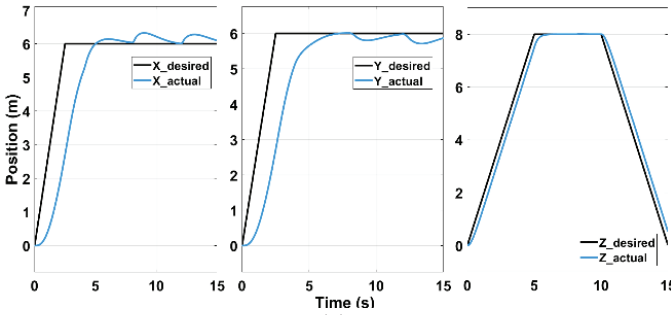

(c)

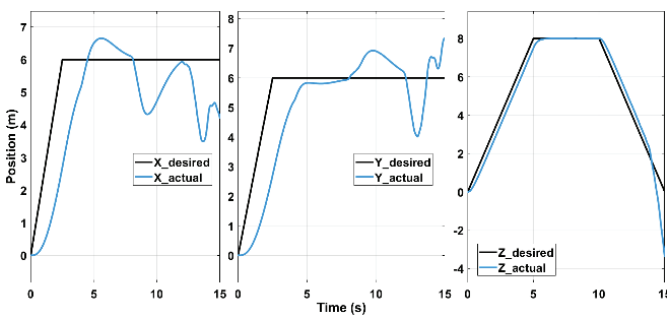

(d)

Figure 10. QuadCoax configuration results. (a)-20N and 200 ms, (b)- 20N and 400ms, (c)- 25N and 200 ms, (d)- 25N and 400 ms.

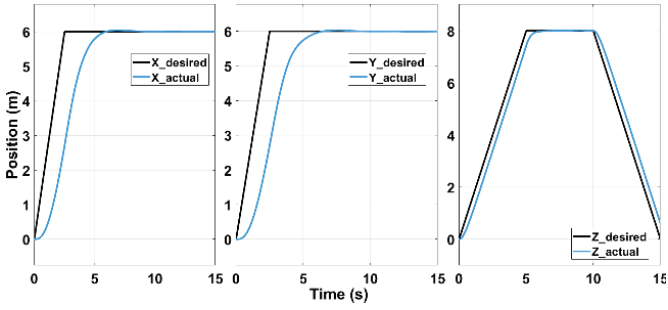

(a)

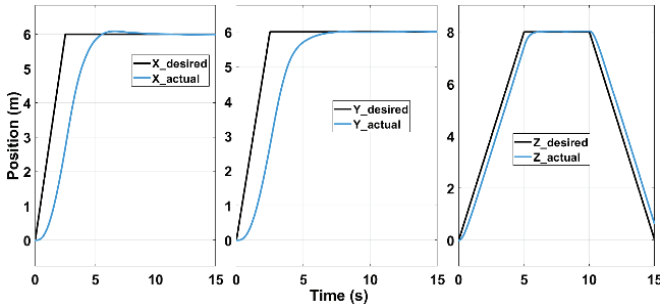

(b)

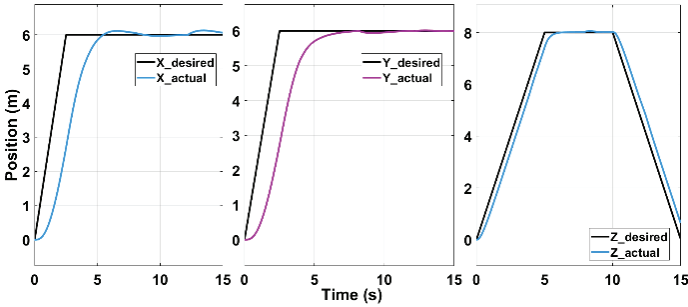

(c)

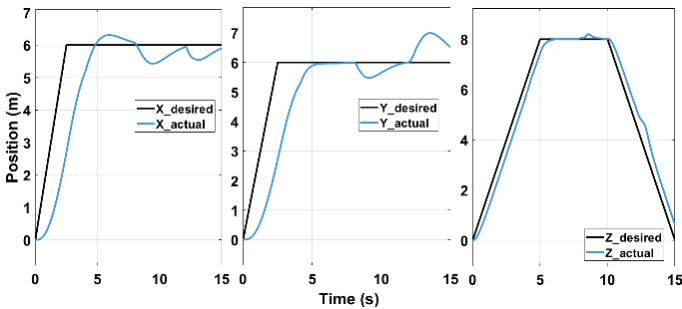

(d)

Figure. 11. Proposed configuration results. (a)-20N and 200 ms, (b)- 20N and 400ms, (c)- 25N and 200 ms, (d)-25N and 400 ms.

The graphical results of the simulations performed are given in Figures 9-11. As a performance comparison, the tracking of the reference trajectory in three axes of all three vehicle types was taken into account. According to the graphical results, it can be said that there is no significant difference between the performances in the z-axis. However, there are significant differences between the performances of the vehicles in the x and y axes. Especially in the case where the applied impact force is high and the duration of the impact, this difference becomes even more pronounced.

In general, it is seen that the model with Coax configuration is very sensitive to the disturbance effect. The most striking of the results is that although the position error of the proposed 8X two-layer configuration UAV is slightly higher than the 8X configuration UAV, their performance is quite close. It is obvious that examining the performances of these three models, which were modeled and simulated, in real flight conditions will yield more accurate results.

References

- Badr, Sherif, Omar Mehrez, and A. E. Kabeel. 2019. "A Design Modification for a Quadrotor UAV: Modeling, Control and Implementation." *Advanced Robotics* 33(1):13–32. doi: 10.1080/01691864.2018.1556116.
- Bangura, Moses, and Robert Mahony. 2017. "Thrust Control for Multirotor Aerial Vehicles." *IEEE Transactions on Robotics* 33(2):390–405. doi: 10.1109/TRO.2016.2633562.
- Bondyra, Adam, Stanisław Gardecki, Przemysław Gąsior, and Wojciech Giernacki. 2016. "Performance of Coaxial Propulsion in Design of Multi-Rotor UAVs." Pp. 523–31 in *Advances in Intelligent Systems and Computing*. Vol. 440.
- Brischetto, Salvatore, Alessandro Ciano, and Carlo Giovanni Ferro. 2016. "A Multipurpose Modular Drone with Adjustable Arms Produced via the FDM Additive Manufacturing Process." *Curved and Layered Structures* 3(1):202–13. doi: 10.1515/cls-2016-0016.
- Buzzatto, Joao, and Minas Liarokapis. 2022. "A Benchmarking Platform and a Control Allocation Method for Improving the Efficiency of Coaxial Rotor Systems." *IEEE Robotics and Automation Letters* 7(2):5302–9. doi: 10.1109/LRA.2022.3153999.
- Çabuk, Nihat, and Şahin Yıldırım. 2021. "Design, Modelling and Control of an Eight-Rotors UAV with Asymmetric Configuration for Use in Remote Sensing Systems." *Journal of Aviation* 5(2):72–81. doi: 10.30518/jav.943804.
- Fu, Zhenzhou, Bing Xiao, Jia Yang, Chaofan Wu, and Yiran Wei. 2017. "Modeling and Control of a New Multicopter." Pp. 6495–6500 in *2017 36th Chinese Control Conference (CCC)*. IEEE.
- Güçlü, Anıl, Dilek Funda Kurtuluş, and Kutluk Bilge Arıkan. 2016. "Sabit ve Döner Kanatlı Hava Aracının Yönelim Dinamiklerinin Hibrit Denetimi." *Sürdürülebilir Havacılık Araştırmaları Dergisi* 1(2):66–73. doi: 10.23890/SUHAD.2016.0112.
- Heidari, Hamidreza, and Martin Saska. 2021. "Collision-Free Trajectory Planning of Multi-Rotor UAVs in a Wind Condition Based on Modified Potential Field." *Mechanism and Machine Theory* 156:104140. doi: 10.1016/j.mechmachtheory.2020.104140.
- Miranda-Colorado, Roger, Luis T. Aguilar, and José E. Herrero-Brito. 2018. "Reduction of Power Consumption on Quadrotor Vehicles via

- Trajectory Design and a Controller-Gains Tuning Stage.” *Aerospace Science and Technology* 78:280–96. doi: 10.1016/j.ast.2018.04.027.
- Muliadi, Jemie, and Benyamin Kusumoputro. 2018. “Neural Network Control System of UAV Altitude Dynamics and Its Comparison with the PID Control System.” *Journal of Advanced Transportation* 2018(D). doi: 10.1155/2018/3823201.
- Oktay, Tuğrul, and Oğuz Köse. 2019. “Dynamic Modeling and Simulation of Quadrotor for Different Flight Conditions.” *European Journal of Science and Technology* (15):132–42. doi: 10.31590/ejosat.507222.
- Quan, Quan, Gen Cui, and Guang Xun Du. 2021. “Controllable Probability and Optimization of Multicopters.” *Aerospace Science and Technology* 119:107162. doi: 10.1016/j.ast.2021.107162.
- Saeed, Adnan S., Ahmad Bani Younes, Chenxiao Cai, and Guowei Cai. 2018. “A Survey of Hybrid Unmanned Aerial Vehicles.” *Progress in Aerospace Sciences* 98(March):91–105. doi: 10.1016/j.paerosci.2018.03.007.
- Sen, Muhammed Arif, and Mete Kalyoncu. 2019. “Grey Wolf Optimizer Based Tuning of a Hybrid LQR-PID Controller for Foot Trajectory Control of a Quadruped Robot.” *Gazi University Journal of Science* 32(2):674–84.
- Shauqee, Mohamad Norherman, Parvathy Rajendran, and Nurulasikin Mohd Suhadis. 2021. “An Effective Proportional-Double Derivative-Linear Quadratic Regulator Controller for Quadcopter Attitude and Altitude Control.” *Automatika* 62(3–4):415–33. doi: 10.1080/00051144.2021.1981527.
- Tilki, Umut, and Ali Can Erüst. 2020. “Second Order Sliding Mode Controller Design with Optimum Characteristic Equation for Four Rotor UAV.” *Mugla Journal of Science and Technology* 6(2):150–57. doi: 10.22531/muglajsci.783506.
- Ucgun, Hakan, Ugur Yuzgec, and Cuneyt Bayilmis. 2021. “A Review on Applications of Rotary-Wing Unmanned Aerial Vehicle Charging Stations.” *International Journal of Advanced Robotic Systems* 18(3). doi: 10.1177/17298814211015863.
- Yıldırım, Şahin, Nihat Çabuk, and Veli Bakırcıoğlu. 2020. “Comparison of Flight Performances of Unmanned Air Vehicle with Six Rotors and Eight Rotors Under Different Disturbance Effects.” *Konya Journal of Engineering Sciences* 8(3):552–62. doi: 10.36306/konjes.594701.

Zabunov, Svetoslav, and Garo Mardirossian. 2018. “Innovative Dodeca-copter Design – Bulgarian Knight.” *International Journal of Aviation, Aeronautics, and Aerospace* 5(4). doi: 10.15394/ijaaa.2018.1293.

Zheng, Peter, Xinkai Tan, Basaran Bahadir Kocer, Erdeng Yang, and Mirko Kovac. 2020. “TiltDrone: A Fully-Actuated Tilting Quadrotor Platform.” *IEEE Robotics and Automation Letters* 5(4):6845–52. doi: 10.1109/LRA.2020.3010460.